

# User Manual

Color Door Camera DRC-40KA



[www.commax.com](http://www.commax.com)

COMMAX Co.,Ltd.



- Thank you for purchasing COMMAX products.
- Please carefully read this User's Guide (in particular, precautions for safety) before using a product and follow instructions to use a product exactly.
- The company is not responsible for any safety accidents caused by abnormal operation of the product.



## Contents

1. Introduction.....	2
2. Important Safeguard.....	3
3. Overview .....	4
4. Package contents.....	6
5. Wiring and Installation .....	7
6. Specification.....	9



## 1. Introduction

Your unit is designed so it can be flush mounted on the or used. When flush mounted on the wall, the stand permits you to the unit for an gular of unit view. The model number is located on the bottom and record the serial number in the space provided below(available). Refer to these numbers whenever you call upon your COMMAX dealer regarding this product.

Model No.

Serial No.

**To prevent fire or shock hazard, do not expose the unit to rain or moisture.**



This symbol is intended to alert the use to the presence of uninsulated **"dangerous Voltage"** within the product' s enclose that may be of sufficient magnitude to constitute a risk of electric shock to persons.



This symbol is intended to alert the use to the presence of important operating and maintenance(servicing) instructions in the literature accompanying the appliance



caution

Risk of electric shock  
do not open



CAUTION : To reduce the risk of electric shock, do not remove cover(or back) no user-serviceable part inside refer servicing to qualified service personnel



## 2. Important Safeguards

- ▲ **Damage Requiring Service:** This equipment from the power source and source and refer servicing to qualified service personnel under the following conditions:
  - Ⓐ when the power is damaged.
  - Ⓑ if liquid has been spilled or objects have fallen into the unit
  - Ⓒ if the equipment has been exposed to rain or water.
  - Ⓓ if the equipment has been dropped or otherwise damaged.
  - Ⓔ when the equipment exhibits a distinct change in performance- this indicates a need for service.
- ▲ **Water and Moisture:** Do not use this product near water, for example, near a bath tub, wash bowl, kitchen sink, or laundry tub, in a wet basement, or near a swimming pool, and the like.
- ▲ **Accessories:** The product may fall, causing serious injury to a child or adult, and serious damage to the appliance. Any mounting of the manufacture's instructions, and should use a mounting accessory recommended by the manufacturer.
- ▲ **Object and Liquid Entry:** Never push objects of any kind into this product through openings as they may touch dangerous voltage points or short-out parts that could result in a fire or electric shock. Never spill liquid of any kind on the product.
- ▲ **Lightning:** For added protection for this product before a lightning storm, or when it is left un attached and un used for long periods of time, unplug it from the wall out it and disconnect the other system. This will prevent damage to the product due to lightning and power-line surges. If you live in an area heavily prone to lightning storms, it is recommended that you invest in power-line, telephone-line, RFcable and actuator/ polarization surge protectors to protect your appliance system from possible damage

### 3. Overview

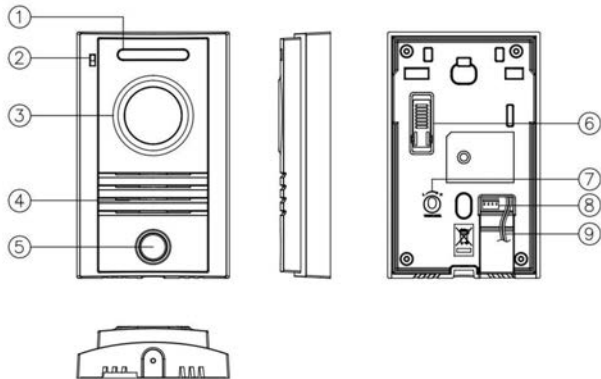

- ① White LED & Illumination Sensor : Offer clear image at night
- ② Microphone : Deliver voice signal from a visitor
- ③ Camera Lens : Transfer image
  - \* Make sure the lens is always kept clean
- ④ Speaker : Deliver voice signal to a visitor
- ⑤ Call Button : Pressed to call to a household
- ⑥ Angle Adjustment Lever : Adjust lens angle
- ⑦ Volume Adjuster : Adjust speaker volume
- ⑧ Monitor Connection Terminal (Polarity with care)
- ⑨ Door Release Connection Line

#### **Note**

**CDV-72UM only if they work with the product.**

**This power is always supplied to the camera, you can use the motion detection feature.**



## 4. Package contents

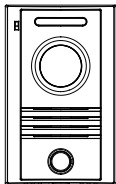

Entrance Camera  
(DRC-40KA)

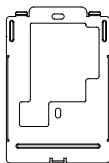

Mounting Bracket

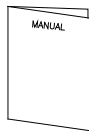

Manual



T4X18 (2EA)  
Bracket Fixing Screw



M3X8 (1EA)  
Camera Fixing Screw



Volume Sheet

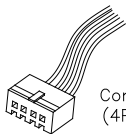

Connector  
(4PX200)



## 5. Wiring and Installation

1. Match the fix the whole in the wall and the fixing bracket [FIG.1]
2. Match and connect monitor line as shown below [FIG.2]  
(#1: Audio, #2: GND, #3: DC12V, #4: Video)
3. Adjust camera location on the wall by checking the image on monitor screen and fix its location
4. Connect the Door Release Connection Line as shown below [FIG.2]
5. Tighten a screw at the bottom side of the camera [FIG.1]

[FIG.1]

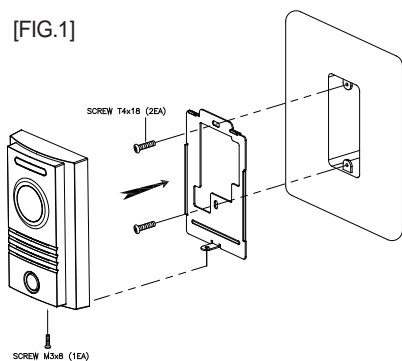

[FIG.2]

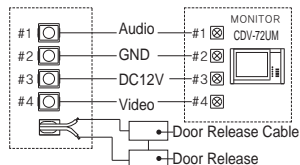

### (Note)

If you want to work with only CDV-72UM products,  
You can use the motion detection feature.



► Position of camera

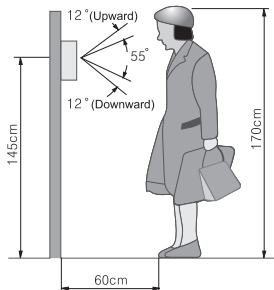

► Installation place

- Do not install the product where direct rays of the sun reach the camera lens.
- Adjust the position by using the angle adjuster (in the back).
- Install a separate lighting at night for better picture quality.

► Cautions at a time of installation

1. Do not install where there is much dust, waste or humidity.
2. Make sure to connect accurately.
3. Make sure to fix it tightly so that it does not come off due to vibration.
4. Avoid places where there are direct rays of the sun or where it rains a lot.
5. Take good care of it to prevent dust or cracks on the window of the door camera lens.



## 6. Specification

Model No.	DRC-40KA			
Rated Voltage / Power Consumption	DC 12V (Supplied from monitor)			
Wiring (Main Unit / Door Release)	4 wires to a monitor (polarity) 2 wires to the door release (non-polarity)			
Sensor Type	CMOS IMAGE SENSOR			
Video Transmission Standard	NTSC or PAL STANDARD.			
Communication	Simultaneous communication			
Minimum Illumination	0.1 Lux (within 300mm)			
LED	Embedded night LED (activated at night)			
Effective Viewing Angle	Horizontal 75°, Vertical 55°			
Angle Adjustment	Up, down 12 Degrees			
Operating Temperature	-10 (tested up to -40°C) ~ +40			
Weight (g)	400g			
Dimension (mm)	96(W) x 155(H) x 32.5(D)			
Distance between a door camera and monitor	Diameter (pie)	0.5	0.65	0.8
	Diameter (meter)	28m	50m	70m

**COMMAX**

**COMMAX Co.,Ltd.**

513-11, Sangdaewon-dong, Jungwon-gu, Seongnam-si, Gyeonggi-do, Korea  
Int'l Business Dept. : Tel.; +82-31-7393-540~550 Fax.; +82-31-745-2133  
Web site : [www.commax.com](http://www.commax.com)

*Printed In Korea / 2014.11.105*