

# User Manual

GUARD STATION(Gate View System)  
CDS-4GS



- Thank you for purchasing COMMAX products.
- Please carefully read this User's Guide (in particular, precautions for safety) before using a product and follow instructions to use a product exactly.
- The company is not responsible for any safety accidents caused by abnormal operation of the product.



## Contents

1. Greetings .....	1
2. Warnings and caution .....	2
3. Parts Name and functions. ....	4
4. Communication with a household. ....	5
5. Communication with a lobby phone. ....	6
6. Call to guard station phone & switching function .....	6
7. Call/Talk duration & Finishing the call .....	6
8. Wiring diagram. ....	7
9. Specifications. ....	7
10. Miscellaneous .....	8



## 1. Greetings

- \* Thank you very much for purchasing of COMMAX products.
- \* Please read carefully this user manual and follow its rules.

## 2. Warnings and caution

Please follow the things described below in order to prevent any danger or property damage.

	<b>Warning</b>	It may cause a serious damage or injury if violated.		Prohibition.
	<b>Caution</b>	It may cause a minor damage or injury if violated.		No disassembly
				No touch
				Must follow strictly.
				Shows plugging out the power cord without an exception
				Shows the warning and caution for an electric shock.
				Shows the warning and caution for a fire.

### Warning

#### Power & Installation

Please don't use several products at the same time on one power socket.

- It may cause a fire due to an abnormal overheating.



Please don't bend the power cable excessively or it may cause an electric shock.

- fire when using a damaged power cable.

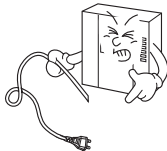

Please don't handle the power cable with a wet hand.

- It may cause an electric shock.

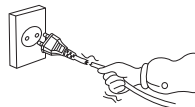

Please plug out the power cable from the socket when not using it for a long period of time.

- It may shorten the product lifespan or cause a fire.

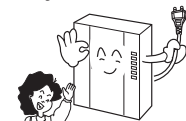

Please don't install the product in the place where there is much oil, smoke or humidity.

- It may cause an electric shock or fire.

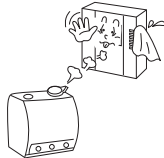

Please don't install the product with the lightning and thunder.

- It may cause an electric shock or fire.

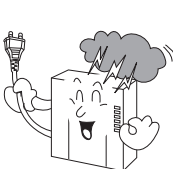

Please don't use and connect this product with other products with different rated voltage

- It may cause a disorder or fire.

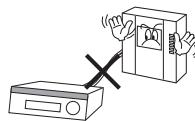

When installing the product that generates heat, please install the product away from the wall (10cm) for the ventilation.

- It may cause a fire due to the increased internal temperature.

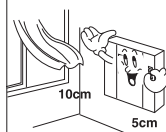

## ⚠ Warning

### Cleaning & Use

Please don't disassemble, repair or rebuild this product arbitrarily (please contact the service center if a repair is needed).

- It may cause an electric shock or fire.



If an abnormal sound, burning smell or smoke is coming out of the product, please plug out the power cable and contact a service center.

- It may cause an electric shock or fire.



Please don't insert any metallic or burnable materials into the ventilation hole.

- It may cause an electric shock or fire.



Please use only the designated batteries for the products of using DC power.

- It may cause an electric shock or fire.



## ⚠ Caution

### Power & Installation

Please plug the power cable firmly into the inner end.

- It may cause a fire.

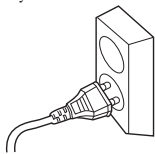

Please hold the plug tightly when unplugging the power cable (a part of the copper wire may be disconnected if the grabbing is only made on the cord when pulling out the cable).

- It may cause an electric shock or fire.

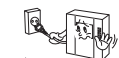

When connecting the power cables after cutting the cable, please install the product with power off.

- It may cause an electric shock or fire.

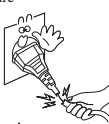

When installing the product, please fix it firmly while using the wall-mounting unit and screws.

- It may cause an injury from the falling object.

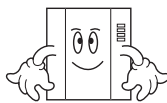

Please be careful when using an AC circuit breaker since there is a possibility of an electric shock.

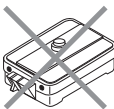

Please check the use voltage and current for the DC-only products and use the appropriate rectifier.

- It may cause a fire.



Please avoid direct rays of the sun or heating devices at a time of installation.

- It may cause a fire.

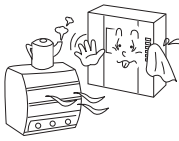

Please don't install the product on an unstable place or small support board.

- It may cause an injury if it falls down while in use.



### Cleaning & Use

When cleaning the product, please rub it with a soft and dry cloth after plugging out the power cable. (Please don't use any chemical products such as wax, benzene, alcohol or cleanser.)



Please don't drop the product on the ground and don't apply a shock.

- It may cause a failure.

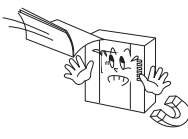

Please use the designated connection cable within the maximum calling distance designated for the product.

- It may reduce the product performance.





### 3. Parts Name and functions.

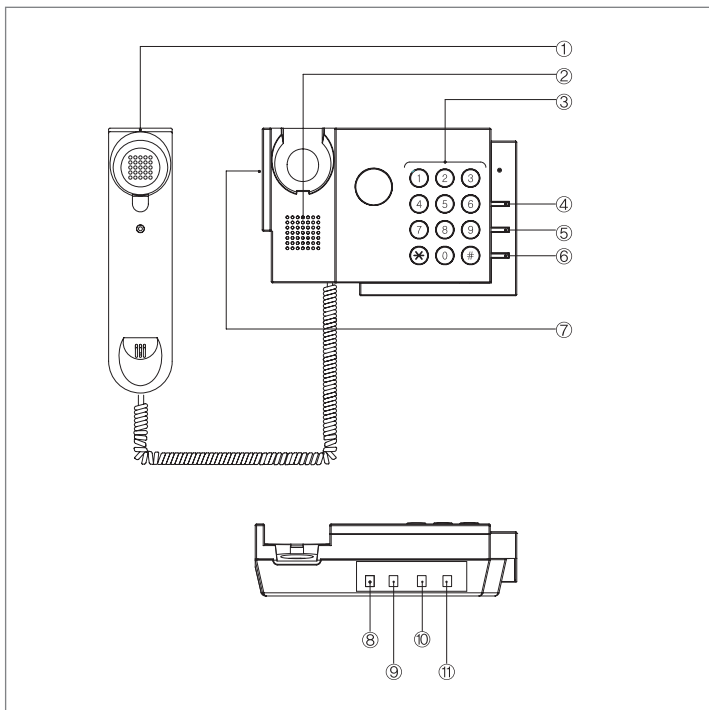

No.	Description	No.	Description
1	Handset	7	Ringer Volume Control button
2	Speaker	8	MASTER/SLAVE select switch
3	Dial buttons	9	Power ON/OFF switch
4	Power indicator	10	Connection terminal for lobby phone
5	Call button (CALL)		
6	Door Open button (OPEN)	11	Power input port(DC 12V)

\* Ringer volume control button : Lower or increase the ringer volume.

\* In case of use of two guard station units, one should be set as Master and the other as Slave.

(Guard station unit number in system configuration : MASTER 1, SLAVE 1)

CDS-4GS, which is a guard station unit in Gate view system. Another CDS-4GS is connectable as Slave unit. (Power indicator is on when power switch is on)

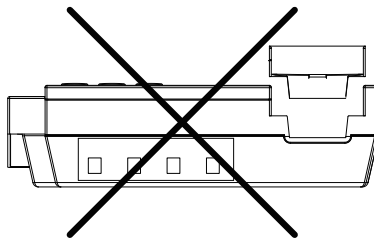
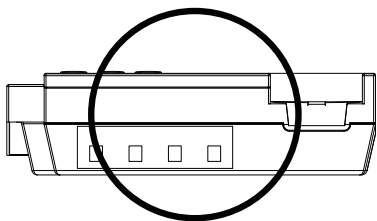

► **Note**

1. Put down the handset correctly after finishing talk.  
(Inappropriate positioning of handset can be a cause of busy line.)
2. Be sure to turn off guard station unit before registering household number at lobby phone.



## **4. Communication with a household.**

### **1. Receiving a call from a household**

- 1) Ringing should be heard (Ringer volume level is adjustable with volume switch)
- 2) Communication starts when being picked up the handset.
- 3) Put the handset properly when the communication is finished.

\* In case of using two guard station units in a system, they go off at the same time when they have a call and conversation begins when one of them is picked up.

### **2. Making a call to a household.**

- 1) Press the desired the household number and then push the call button.  
[ How to make a call: input building number – Press (\*) button – input household number – press (#) button ]
- 2) Communication starts when the household response.
- 3) Put the handset properly when the communication is finished.

\* Try again for a while when you hear "busy" sound.



## 5. Communication with a lobby phone.

- 1) Ringer sound is heard when receiving a call from a lobby phone.
- 2) Communication starts when being picked up the handset.
- 3) Press the "Door open" button to open the entrance.  
(The communication is finished after door is open.)
- 4) Put the handset properly when the communication is finished.



## 6. Call to guard station phone & switching function

\* Making a call to a guard station

Pick up the handset and press the “ Call” button to talk with the other guard station.

\* Switching function

- 1) Press the "Call” button on the line to talk with the other guard station.
- 2) Pass the call on the line to other household  
(Input building number – Press (\*) button – Press household number – Press (#) button)  
(In case of pressing wrong inappropriate number, press the "Call” button to return to talk status)



## 7. Call/Talk duration & Finishing the call

- 1) Ringing lasts for 30 seconds.
- 2) Communication lasts for 60 seconds.

## 8. Wiring diagram.

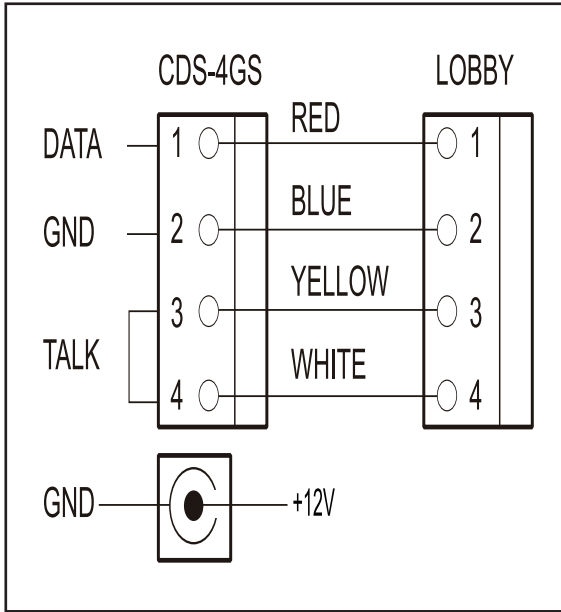

## 9. Specifications.

Item	Descriptions	
Wiring	Common lobby phone : 4 wires	
Communication way	Full duplex	
Distance	Guard station Common	Ø 0.65mm
	lobby household	Max. 1km





## 10. Miscellaneous

- \* Please carefully read this User's Guide before calling service man After checking the entire check list, please contact customer service center. We will do our best to make you satisfy with our services.

# **COMMAX**

## **COMMAX Co.,Ltd.**

---

513-11, Sangdaewon-dong, Jungwon-gu, Seongnam-si, Gyeonggi-do, Korea

Int'l Business Dept. : Tel.; +82-31-7393-540~550 Fax.; +82-31-745-2133

Web site : [www.commax.com](http://www.commax.com)

*Printed In Korea / 2010.09.103*