

SIP-T2 Series/T19(P) E2/T4 Series IP Phones Administrator Guide

Copyright

Copyright © 2015 YEALINK NETWORK TECHNOLOGY

Copyright © 2015 Yealink Network Technology CO., LTD. All rights reserved. No parts of this publication may be reproduced or transmitted in any form or by any means, electronic or mechanical, photocopying, recording, or otherwise, for any purpose, without the express written permission of Yealink Network Technology CO., LTD. Under the law, reproducing includes translating into another language or format.

When this publication is made available on media, Yealink Network Technology CO., LTD. gives its consent to downloading and printing copies of the content provided in this file only for private use but not for redistribution. No parts of this publication may be subject to alteration, modification or commercial use. Yealink Network Technology CO., LTD. will not be liable for any damages arising from use of an illegally modified or altered publication.

Warranty

THE SPECIFICATIONS AND INFORMATION REGARDING THE PRODUCTS IN THIS GUIDE ARE SUBJECT TO CHANGE WITHOUT NOTICE. ALL STATEMENTS, INFORMATION, AND RECOMMENDATIONS IN THIS GUIDE ARE BELIEVED TO BE ACCURATE AND PRESENTED WITHOUT WARRANTY OF ANY KIND, EXPRESS OR IMPLIED. USERS MUST TAKE FULL RESPONSIBILITY FOR THEIR APPLICATION OF PRODUCTS.

YEALINK NETWORK TECHNOLOGY CO., LTD. MAKES NO WARRANTY OF ANY KIND WITH REGARD TO THIS GUIDE, INCLUDING, BUT NOT LIMITED TO, THE IMPLIED WARRANTIES OF MERCHANTABILITY AND FITNESS FOR A PARTICULAR PURPOSE. Yealink Network Technology CO., LTD. shall not be liable for errors contained herein nor for incidental or consequential damages in connection with the furnishing, performance, or use of this guide.

Declaration of Conformity



Hereby, Yealink Network Technology CO., LTD. declares that this phone is in conformity with the essential requirements and other relevant provisions of the CE, FCC.

CE Mark Warning

This device is marked with the CE mark in compliance with EC Directives 2006/95/EC and 2004/108/EC.

Part 15 FCC Rules

Any Changes or modifications not expressly approved by the party responsible for compliance could void the user's authority to operate the equipment.

This device is compliant with Part 15 of the FCC Rules. Operation is subject to the following two conditions:

1. This device may not cause harmful interference.
2. This device must accept any interference received, including interference that may cause undesired operation.

Class B Digital Device or Peripheral

Note: This device is tested and complies with the limits for a Class B digital device, pursuant to Part 15 of the FCC Rules. These limits are designed to provide reasonable protection against harmful interference in a residential installation. This equipment generates, uses, and can radiate radio frequency energy and, if not installed and used in accordance with the instructions, may cause harmful interference to radio communications. However, there is no guarantee that interference will not occur in a particular installation. If this equipment does cause harmful interference to radio or television reception, which can be determined by turning the equipment off and on, the user is encouraged to try to correct the interference by one or more of the following measures:

1. Reorient or relocate the receiving antenna.
2. Increase the separation between the equipment and receiver.
3. Connect the equipment into an outlet on a circuit different from that to which the receiver is connected.
4. Consult the dealer or an experience radio/TV technician for help.

WEEE Warning



To avoid the potential effects on the environment and human health as a result of the presence of hazardous substances in electrical and electronic equipment, end users of electrical and electronic equipment should understand the meaning of the crossed-out wheeled bin symbol. Do not dispose of WEEE as unsorted municipal waste and have to collect such WEEE separately.

Customer Feedback

We are striving to improve our documentation quality and we appreciate your feedback. Email your opinions and comments to DocsFeedback@yealink.com.

GNU GPL INFORMATION

Yealink IP phone firmware contains third-party software under the GNU General Public License (GPL). Yealink uses software under the specific terms of the GPL. Please refer to the GPL for the exact terms and conditions of the license.

The original GPL license, source code of components licensed under GPL and used in Yealink products can be downloaded from Yealink web site:

<http://www.yealink.com/GPLOpenSource.aspx?BaseInfoCatId=293&NewsCatId=293&CatId=293>.

About This Guide

This guide is intended for administrators who need to properly configure, customize, manage, and troubleshoot the IP phone system rather than end-users. It provides details on the functionality and configuration of IP phones.

Many of the features described in this guide involve network settings, which could affect the IP phone's performance in the network. So an understanding of IP networking and a prior knowledge of IP telephony concepts are necessary.

Documentations

This guide covers SIP-T48G, SIP-T46G, SIP-T42G, SIP-T41P, SIP-T29G, SIP-T27P, SIP-T23P/G, SIP-T21(P) E2 and SIP-T19(P) E2 IP phones. The following related documents are available:

- Quick Start Guides, which describe how to assemble IP phones and configure the most basic features available on IP phones.
- User Guides, which describe the basic and advanced features available on IP phones.
- Auto Provisioning Guide, which describes how to provision IP phones using the configuration files.
- Description of Configuration Parameters in CFG Files, which describes all configuration parameters in configuration files.
- <y0000000000xx>.cfg and <MAC>.cfg template configuration files.
- IP Phones Deployment Guide for BroadSoft UC-One Environments, which describes how to configure BroadSoft features on the BroadWorks web portal and IP phones.

For support or service, please contact your Yealink reseller or go to Yealink Technical Support online: <http://support.yealink.com/>.

In This Guide

The information detailed in this guide is applicable to firmware version 80 or higher. The firmware format is like x.x.x.x.rom. The second x from left must be greater than or equal to 80 (e.g., the firmware version of SIP-T23G IP phone: 44.80.0.60.rom). This administrator guide includes the following chapters:

- Chapter 1, "[Product Overview](#)" describes the SIP components and SIP IP phones.
- Chapter 2, "[Getting Started](#)" describes how to install and connect IP phones, configuration methods and resource files.

- Chapter 3, “[Configuring Basic Features](#)” describes how to configure the basic features on IP phones.
- Chapter 4, “[Configuring Advanced Features](#)” describes how to configure the advanced features on IP phones.
- Chapter 5, “[Configuring Audio Features](#)” describes how to configure the audio features on IP phones.
- Chapter 6, “[Configuring Security Features](#)” describes how to configure the security features on IP phones.
- Chapter 7, “[Troubleshooting](#)” describes how to troubleshoot IP phones and provides some common troubleshooting solutions.
- Chapter 8, “[Appendix](#)” provides the glossary, reference information about IP phones compliant with [RFC 3261](#), SIP call flows and the sample configuration files.

Summary of Changes

This section describes the changes to this guide for each release and guide version.

Changes for Release 80, Guide Version 80.60

Documentations of the newly released SIP-T19(P) E2 IP phones have also been added. The following sections are new for this version:

- [Ringing Timeout](#) on page 381
- [Shared Call Appearance \(SCA\)](#) on page 450
- [Bridge Lines Appearance \(BLA\)](#) on page 462
- [Short Message Service \(SMS\)](#) on page 471
- [Appendix F: Configurations Defined Never be Saved to <MAC>-local.cfg file](#) on page 768

Major updates have occurred to the following sections:

- [Documentations](#) on page v
- [Expansion Module](#) on page 14
- [Reading Icons](#) on page 30
- [Configuration Files](#) on page 38
- [Obtaining Configuration Files and Resource Files](#) on page 42
- [Account Registration](#) on page 112
- [Auto Answer](#) on page 232
- [IP Direct Auto Answer](#) on page 237
- [Do Not Disturb \(DND\)](#) on page 251

- [Return Code When Refuse](#) on page 267
- [Call Forward](#) on page 284
- [LDAP](#) on page 407
- [Action URL](#) on page 507
- [Action URI](#) on page 527
- [Server Redundancy](#) on page 534

Changes for Release 80, Guide Version 80.21

The following sections are new for this version:

- [Expansion Module](#) on page 14
- [Obtaining Configuration Files and Resource Files](#) on page 42
- [DHCP Option](#) on page 62
- [Bluetooth](#) on page 107
- [Enable Page Tips](#) on page 109
- [Label Length](#) on page 110
- [Account Registration](#) on page 112
- [Display Method on Dialing](#) on page 126
- [Redial Tone](#) on page 227
- [Ringer Device for Headset](#) on page 229
- [IP Direct Auto Answer](#) on page 237
- [Allow IP Call](#) on page 239
- [Accept SIP Trust Server Only](#) on page 240
- [Transfer Mode via Dsskey](#) on page 313
- [Allow Trans Exist Call](#) on page 315
- [Call Number Filter](#) on page 346
- [Call Timeout](#) on page 380
- [Send user=phone](#) on page 381
- [SIP Send MAC](#) on page 384
- [SIP Send Line](#) on page 386
- [Reserve # in User Name](#) on page 388
- [Password Dial](#) on page 390
- [Unregister When Reboot](#) on page 392
- [100 Reliable Retransmission](#) on page 394
- [Reboot in Talking](#) on page 396

- [Logon Wizard](#) on page 504
- [Auto-Logout Time](#) on page 672
- [Appendix E: Auto Provisioning Flowchart \(Keep user personalized configuration settings\)](#) on page 767

Major updates have occurred to the following sections:

- [DHCP](#) on page 58
- [Time and Date](#) on page 131
- [Language](#) on page 148
- [Input Method](#) on page 158
- [Logo Customization](#) on page 163
- [Softkey Layout](#) on page 167
- [Dial Plan](#) on page 179
- [Directory](#) on page 199
- [Search Source in Dialing](#) on page 201
- [Local Directory](#) on page 209
- [SIP Session Timer](#) on page 273
- [Call Hold](#) on page 278
- [DTMF](#) on page 359
- [Remote Phone Book](#) on page 400
- [VLAN](#) on page 560
- [Network Address Translation](#) on page 599
- [Comfort Noise Generation](#) on page 664
- [Phone Lock](#) on page 674
- [Troubleshooting Methods](#) on page 715
- [Troubleshooting Solutions](#) on page 733

Changes for Release 80, Guide Version 80.20

This version is updated to incorporate SIP-T48G IP phones. Documentations of the newly released SIP-T27P and SIP-T21(P) E2 IP phones have also been added.

Major updates have occurred to the following sections:

- [Reading Icons](#) on page 28
- [Configuration Files](#) on page 38
- [Power Indicator LED](#) on page 91
- [Backlight](#) on page 101

- [Time and Date](#) on page 130
- [Auto Answer](#) on page 232
- [Return Code When Refuse](#) on page 267
- [DTMF](#) on page 359
- [Phone Lock](#) on page 674
- [Appendix B: Time Zones](#) on page 749

Changes for Release 80, Guide Version 80.6

This version is updated to incorporate SIP-T46G, SIP-T42G, SIP-T41P and SIP-T29G IP phones. The following sections are new for this version:

- [Wallpaper](#) on page 99
- [Hide Features Access Code](#) on page 442

Major updates have occurred to the following sections:

- [DHCP](#) on page 58
- [Call Display](#) on page 123
- [Input Method](#) on page 158
- [BLF List](#) on page 433
- [IPv6 Support](#) on page 617
- [Viewing Log Files](#) on page 715

Table of Contents

About This Guide	V
Documentations.....	v
In This Guide	v
Summary of Changes	vi
Changes for Release 80, Guide Version 80.60.....	vi
Changes for Release 80, Guide Version 80.21.....	vii
Changes for Release 80, Guide Version 80.20.....	viii
Changes for Release 80, Guide Version 80.6.....	ix
 Table of Contents	 X
 Product Overview	 1
VoIP Principle.....	1
SIP Components.....	2
SIP IP Phone Models.....	3
Physical Features of IP Phones	4
Key Features of IP Phones.....	13
Expansion Module.....	14
 Getting Started.....	 17
Connecting the IP Phones	17
Initialization Process Overview	27
Verifying Startup	28
Reading Icons	30
Configuration Methods.....	38
Phone User Interface.....	38
Web User Interface	38
Configuration Files.....	38
Obtaining Configuration Files and Resource Files	42
Keep User Personalized Settings	45
Configuration Parameters.....	45
Scenario A Keep user personalized configuration settings	47
Scenario B Clear user personalized configuration settings	51
Scenario C Keep user personalized settings after factory reset	52
Scenario D Import or export the local configuration file	54
Provisioning Server.....	56

Supported Provisioning Protocols	56
Setting up the Provisioning Server.....	56
Deploying Phones from the Provisioning Server	57
Configuring Basic Network Parameters	58
DHCP	58
DHCP Option.....	62
Configuring Network Parameters Manually	67
PPPoE	73
Configuring Transmission Methods of the Internet Port and PC Port	76
Configuring PC Port Mode	80
Upgrading Firmware.....	81
Upgrading Firmware via Web User Interface	82
Upgrading Firmware from the Provisioning Server	83
Configuring Basic Features	89
Power Indicator LED	91
Notification Popups.....	95
Contrast	98
Wallpaper.....	99
Backlight.....	103
Bluetooth	107
Enable Page Tips	109
Label Length.....	110
Account Registration	112
Call Display	123
Display Method on Dialing.....	126
Web Server Type.....	128
Time and Date	131
NTP Time Server	132
Time and Date Settings	137
Daylight Saving Time	141
Language	148
Loading Language Packs	149
Specifying the Language to Use.....	156
Input Method	158
Input Method Customization.....	158
Specifying the Default Input Method	162
Logo Customization	163
Customizing a Logo Template File	164
Configuring the Logo Shown on the Idle Screen.....	165
Softkey Layout.....	167
Customizing Softkey Layout Template File.....	169
Key As Send	175
Dial Plan.....	179

Replace Rule	180
Dial-now	184
Area Code.....	190
Block Out	192
Hotline	194
Off Hook Hot Line Dialing	197
Directory	199
Customizing a Directory Template File.....	199
Search Source in Dialing.....	201
Customizing a Super Search Template File	201
Save Call Log.....	204
Call List Show Number	206
Missed Call Log	207
Local Directory	209
Customizing a Local Contact File.....	209
Live Dialpad.....	222
Call Waiting.....	224
Redial Tone.....	227
Ringer Device for Headset	229
Auto Redial.....	230
Auto Answer.....	232
IP Direct Auto Answer.....	237
Allow IP Call	239
Accept SIP Trust Server Only	240
Call Completion.....	241
Anonymous Call.....	243
Anonymous Call Rejection	247
Do Not Disturb (DND).....	251
Busy Tone Delay.....	266
Return Code When Refuse	267
Early Media.....	269
180 Ring Workaround.....	269
Use Outbound Proxy in Dialog.....	271
SIP Session Timer	273
Session Timer	275
Call Hold.....	278
Music on Hold.....	281
Call Forward	284
Call Transfer	305
Network Conference	308
Feature Key Synchronization.....	310
Transfer on Conference Hang Up	312
Transfer Mode via Dsskey.....	313
Allow Trans Exist Call.....	315

Directed Call Pickup.....	316
Group Call Pickup.....	327
Dialog Info Call Pickup.....	337
Recent Call In Dialing.....	339
ReCall.....	340
Call Number Filter.....	346
Call Park.....	347
Calling Line Identification Presentation.....	352
Connected Line Identification Presentation.....	357
DTMF.....	359
Methods of Transmitting DTMF Digit.....	360
Suppress DTMF Display.....	365
Transfer via DTMF.....	367
Play Local DTMF Tone.....	369
Allow Mute.....	370
Intercom.....	372
Outgoing Intercom Calls.....	372
Incoming Intercom Calls.....	377
Call Timeout.....	380
Ringing Timeout.....	381
Send user=phone.....	382
SIP Send MAC.....	384
SIP Send Line.....	386
Reserve # in User Name.....	388
Password Dial.....	390
Unregister When Reboot.....	392
100 Reliable Retransmission.....	394
Reboot in Talking.....	396
Configuring Advanced Features.....	399
Remote Phone Book.....	400
Customizing Remote Phone Book Template File.....	400
LDAP.....	407
Busy Lamp Field (BLF).....	421
BLF List.....	435
Hide Features Access Code.....	442
Automatic Call Distribution (ACD).....	443
Shared Call Appearance (SCA).....	450
Bridge Lines Appearance (BLA).....	462
Message Waiting Indicator.....	465
Short Message Service (SMS).....	471
Multicast Paging.....	472
Sending RTP Stream.....	472
Receiving RTP Stream.....	484

Call Recording	488
Hot Desking.....	497
Logon Wizard	504
Action URL	507
Action URI.....	527
Configuring Trusted IP Address for Action URI.....	530
Capturing the Current Screen of the Phone.....	532
Server Redundancy.....	534
Server Domain Name Resolution.....	548
Static DNS Cache	552
VLAN	560
LLDP	561
CDP	564
Manual Configuration for VLAN.....	566
DHCP VLAN	570
VPN.....	573
Voice Quality Monitoring	576
RTCP-XR.....	576
VQ-RTCPXR.....	577
Quality of Service	595
Network Address Translation	599
NAT Types.....	599
NAT Traversal	600
Keep Alive.....	606
Rport	608
Real-Time Transport Protocol.....	610
TR-069 Device Management	611
IPv6 Support	617

Configuring Audio Features627

Ring Tones	627
Distinctive Ring Tones.....	632
Tones	638
Voice Mail Tone.....	645
Headset Prior	646
Dual Headset.....	648
Sending Volume.....	650
Audio Codecs	651
Acoustic Clarity Technology.....	661
Acoustic Echo Cancellation	661
Background Noise Suppression.....	662
Automatic Gain Control	662
Voice Activity Detection	662
Comfort Noise Generation	664

Jitter Buffer	665
Configuring Security Features.....	669
User Password	669
Administrator Password	671
Auto-Logout Time.....	672
Phone Lock	674
Transport Layer Security.....	684
Secure Real-Time Transport Protocol.....	694
Encrypting Configuration Files	697
802.1X Authentication	702
Troubleshooting	715
Troubleshooting Methods	715
Viewing Log Files.....	715
Capturing Packets	725
Enabling Watch Dog Feature	728
Getting Information from Status Indicators.....	730
Analyzing Configuration File	730
Troubleshooting Solutions	733
Why is the LCD screen blank?	734
Why doesn't the IP phone get an IP address?	734
Why does the IP phone display "No Service"?	734
How do I find the basic information of the IP phone?.....	734
Why doesn't the IP phone upgrade firmware successfully?.....	734
Why doesn't the IP phone display time and date correctly?	735
Why do I get poor sound quality during a call?	735
What is the difference between a remote phone book and a local phone book?	735
What is the difference among user name, register name and display name?	736
How to reboot the IP phone remotely?	736
Why does the IP phone use DOB format logo file instead of popular BMP, JPG and so on?	737
How to increase or decrease the volume?	737
What will happen if I connect both PoE cable and power adapter? Which has the higher priority?.....	737
What is auto provisioning?	738
What is PnP?	738
Why doesn't the IP phone update the configuration?	738
What do "on code" and "off code" mean?	738
How to solve the IP conflict problem?	739
How to reset the IP phone to factory configurations?.....	739
How to restore the administrator password?	739
Why does the IP phone play the local ringback tone instead of media when placing a	

long distance number without plus 0? 740
 What communication protocols and ports do Yealink IP phones support? 741
 What is the difference between enabling and disabling the RFC 2543 Hold feature?. 744
 How can I verify the firmware generation and version of the phone? 745

Appendix747

Appendix A: Glossary 747
 Appendix B: Time Zones 749
 Appendix C: Trusted Certificates 750
 Appendix D: Configuring DSS Key 751
 Appendix E: Auto Provisioning Flowchart (Keep user personalized configuration settings) 767
 Appendix F: Configurations Defined Never be Saved to <MAC>-local.cfg file 768
 Appendix G: SIP (Session Initiation Protocol) 775
 RFC and Internet Draft Support 775
 SIP Request 778
 SIP Header 779
 SIP Responses 781
 SIP Session Description Protocol (SDP) Usage 783
 Appendix H: SIP Call Flows 784
 Successful Call Setup and Disconnect 784
 Unsuccessful Call Setup—Called User is Busy 787
 Unsuccessful Call Setup—Called User Does Not Answer 789
 Successful Call Setup and Call Hold 791
 Successful Call Setup and Call Waiting 794
 Call Transfer without Consultation 799
 Call Transfer with Consultation 803
 Always Call Forward 808
 Busy Call Forward 811
 No Answer Call Forward 814
 Call Conference 817

Index823

Product Overview

This chapter contains the following information about IP phones:

- [VoIP Principle](#)
- [SIP Components](#)
- [SIP IP Phone Models](#)
- [Expansion Module](#)

VoIP Principle

VoIP

VoIP (Voice over Internet Protocol) is a technology using the Internet Protocol instead of traditional Public Switch Telephone Network (PSTN) technology for voice communications.

It is a family of technologies, methodologies, communication protocols, and transmission techniques for the delivery of voice communications and multimedia sessions over IP networks. The H.323 and Session Initiation Protocol (SIP) are two popular VoIP protocols that are found in widespread implementation.

H.323

H.323 is a recommendation from the ITU Telecommunication Standardization Sector (ITU-T) that defines the protocols to provide audio-visual communication sessions on any packet network. The H.323 standard addresses call signaling and control, multimedia transport and control, and bandwidth control for point-to-point and multi-point conferences.

It is widely implemented by voice and video conference equipment manufacturers, is used within various Internet real-time applications such as GnuGK and NetMeeting and is widely deployed by service providers and enterprises for both voice and video services over IP networks.

SIP

SIP (Session Initiation Protocol) is the Internet Engineering Task Force's (IETF's) standard for multimedia conferencing over IP. It is an ASCII-based, application-layer control protocol (defined in [RFC 3261](#)) that can be used to establish, maintain, and terminate calls between two or more endpoints. Like other VoIP protocols, SIP is designed to address functions of signaling and session management within a packet telephony

network. Signaling allows call information to be carried across network boundaries. Session management provides the ability to control attributes of an end-to-end call.

SIP provides capabilities to:

- Determine the location of the target endpoint -- SIP supports address resolution, name mapping, and call redirection.
- Determine media capabilities of the target endpoint -- Via Session Description Protocol (SDP), SIP determines the "lowest level" of common services between endpoints. Conferences are established using only media capabilities that can be supported by all endpoints.
- Determine the availability of the target endpoint -- A call cannot be completed because the target endpoint is unavailable, SIP determines whether the called party is already on the IP phone or does not answer in the allotted number of rings. It then returns a message indicating why the target endpoint is unavailable.
- Establish a session between the origin and target endpoint -- The call can be completed, SIP establishes a session between endpoints. SIP also supports mid-call changes, such as the addition of another endpoint to the conference or the change of a media characteristic or codec.
- Handle the transfer and termination of calls -- SIP supports the transfer of calls from one endpoint to another. During a call transfer, SIP simply establishes a session between the transferee and a new endpoint (specified by the transferring party) and terminates the session between the transferee and the transferring party. At the end of a call, SIP terminates the sessions between all parties.

SIP Components

SIP is a peer-to-peer protocol. The peers in a session are called User Agents (UAs). A user agent can function as one of following roles:

- User Agent Client (UAC) -- A client application that initiates the SIP request.
- User Agent Server (UAS) -- A server application that contacts the user when a SIP request is received and that returns a response on behalf of the user.

User Agent Client (UAC)

The UAC is an application that initiates up to six feasible SIP requests to the UAS. The six requests issued by the UAC are: INVITE, ACK, OPTIONS, BYE, CANCEL and REGISTER. When the SIP session is being initiated by the UAC SIP component, the UAC determines the information essential for the request, which is the protocol, the port and the IP address of the UAS to which the request is being sent. This information can be dynamic and will make it challenging to put through a firewall. For this reason, it may be recommended to open the specific application type on the firewall. The UAC is also capable of using the information in the request URI to establish the course of the SIP

request to its destination, as the request URI always specifies the host which is essential. The port and protocol are not always specified by the request URI. Thus if the request does not specify a port or protocol, a default port or protocol is contacted. It may be preferential to use this method when not using an application layer firewall. Application layer firewalls like to know what applications are flowing through which ports and it is possible to use content types of other applications other than the one you are trying to let through what has been denied.

User Agent Server (UAS)

UAS is a server that hosts the application responsible for receiving the SIP requests from a UAC, and on reception it returns a response to the request back to the UAC. The UAS may issue multiple responses to the UAC, not necessarily a single response.

Communication between UAC and UAS is client/server and peer-to-peer.

Typically, a SIP endpoint is capable of functioning as both a UAC and a UAS, but it functions only as one or the other per transaction. Whether the endpoint functions as a UAC or a UAS depends on the UA that initiates the request.

SIP IP Phone Models

This section introduces SIP-T48G, SIP-T46G, SIP-T42G, SIP-T41P, SIP-T29G, SIP-T27P, SIP-T23P/G, SIP-T21(P) E2 and SIP-T19(P) E2 IP phone models. These IP phones are endpoints in the overall network topology, which are designed to interoperate with other compatible equipments including application servers, media servers, internet-working gateways, voice bridges, and other endpoints. These IP phones are characterized by a large number of functions, which simplify business communication with a high standard of security and can work seamlessly with a large number of SIP PBXs.

SIP-T48G, SIP-T46G, SIP-T42G, SIP-T41P, SIP-T29G, SIP-T27P, SIP-T23P/G, SIP-T21(P) E2 and SIP-T19(P) E2 IP phones provide a powerful and flexible IP communication solution for Ethernet TCP/IP networks, delivering excellent voice quality. The high-resolution graphic display supplies content in multiple languages for system status, call log and directory access. IP phones also support advanced functionalities, including LDAP, Busy Lamp Field, Sever Redundancy and Network Conference.

The following IP phone models are described:

- SIP-T48G
- SIP-T46G
- SIP-T42G
- SIP-T41P
- SIP-T29G
- SIP-T27P
- SIP-T23P/G

- SIP-T21(P) E2
- SIP-T19(P) E2

IP phones comply with the SIP standard ([RFC 3261](#)), and they can only be used within a network that supports this model of phone.

For a list of key features available on Yealink IP phones running the latest firmware, refer to [Key Features of IP Phones](#) on page 13.

In order to operate as SIP endpoints in your network successfully, IP phones must meet the following requirements:

- A working IP network is established.
- VoIP gateways are configured for SIP.
- The latest (or compatible) firmware of IP phones is available.
- A call server is active and configured to receive and send SIP messages.

Physical Features of IP Phones

This section lists the available physical features of SIP-T48G, SIP-T46G, SIP-T42G, SIP-T41P, SIP-T29G, SIP-T27P, SIP-T23P/G, SIP-T21(P) E2 and SIP-T19(P) E2 IP phones.

SIP-T48G



Physical Features:

- 7" 800 x 480 pixel color touch screen with backlight
- 24 bit depth color
- 16 VoIP accounts, Broadsoft Validated/Asterisk® Compatible

- HD Voice: HD Codec, HD Handset, HD Speaker
- 26 keys including 7 feature keys
- 1*RJ9 (4P4C) handset port
- 1*RJ9 (4P4C) headset port
- 2*RJ45 10/100/1000Mbps Ethernet ports
- 1*RJ12 (6P6C) expansion module port
- 4 LEDs: 1*power, 1*mute, 1*headset, 1*speakerphone
- Power adapter: AC 100~240V input and DC 5V/2A output
- Power over Ethernet (IEEE 802.3af)
- Built-in USB port, support Bluetooth headset
- Wall Mount

SIPT46G



Physical Features:

- 4.3" 480 x 272 pixel color display with backlight
- 24 bit depth color
- 16 VoIP accounts, Broadsoft Validated/Asterisk® Compatible
- HD Voice: HD Codec, HD Handset, HD Speaker
- 40 keys including 10 line keys
- 1*RJ9 (4P4C) handset port
- 1*RJ9 (4P4C) headset port
- 2*RJ45 10/100/1000Mbps Ethernet ports
- 1*RJ12 (6P6C) expansion module port

- 14 LEDs: 1*power, 10*line, 1*mute, 1*headset, 1*speakerphone
- Power adapter: AC 100~240V input and DC 5V/2A output
- Power over Ethernet (IEEE 802.3af)
- Built-in USB port, support Bluetooth headset
- Wall Mount

SIP-T42G



Physical Features:

- 192 x 64 graphic LCD
- 12 VoIP accounts, Broadsoft Validated/Asterisk® Compatible
- HD Voice: HD Codec, HD Handset, HD Speaker
- 34 keys including 6 line keys
- 1*RJ9 (4P4C) handset port
- 1*RJ9 (4P4C) headset port
- 2*RJ45 10/100/1000Mbps Ethernet ports
- 1*RJ12 (6P6C) EHS36 headset adapter port
- 10 LEDs: 1*power, 6*line, 1*mute, 1*headset, 1*speakerphone
- Power adapter: AC 100~240V input and DC 5V/1.2A output
- Power over Ethernet (IEEE 802.3af)
- Wall Mount

SIPT41P



Physical Features:

- 192 x 64 graphic LCD
- 6 VoIP accounts, Broadsoft Validated/Asterisk® Compatible
- HD Voice: HD Codec, HD Handset, HD Speaker
- 34 keys including 6 line keys
- 1*RJ9 (4P4C) handset port
- 1*RJ9 (4P4C) headset port
- 2*RJ45 10/100Mbps Ethernet ports
- 1*RJ12 (6P6C) EHS36 headset adapter port
- 10 LEDs: 1*power, 6*line, 1*mute, 1*headset, 1*speakerphone
- Power adapter: AC 100~240V input and DC 5V/1.2A output
- Power over Ethernet (IEEE 802.3af)
- Wall Mount

SIP-T29G



Physical Features:

- 4.3" 480 x 272 pixel color display with backlight
- 24 bit depth color
- 16 VoIP accounts, Broadsoft Validated/Asterisk® Compatible
- HD Voice: HD Codec, HD Handset, HD Speaker
- 41 keys including 10 line keys
- 1*RJ9 (4P4C) handset port
- 1*RJ9 (4P4C) headset port
- 2*RJ45 10/100/1000Mbps Ethernet ports
- 1*RJ12 (6P6C) expansion module port
- 13 LEDs: 1*power, 10*line, 1*headset, 1*message
- Power adapter: AC 100~240V input and DC 5V/2A output
- Power over Ethernet (IEEE 802.3af)
- Built-in USB port, support Bluetooth headset
- Wall Mount

SIPT27P



Physical Features:

- 240x120 graphic LCD
- 6 VoIP accounts, Broadsoft Validated/Asterisk® Compatible
- HD Voice: HD Codec, HD Handset, HD Speaker
- 39 keys including 8 line keys
- 1*RJ9 (4P4C) handset port
- 1*RJ9 (4P4C) headset port
- 2*RJ45 10/100Mbps Ethernet ports
- 1*RJ12 (6P6C) expansion module port
- 11*LEDs: 1*power, 8*line, 1*headset, 1*message
- Power adapter: AC 100~240V input and DC 5V/1.2A output
- Power over Ethernet (IEEE 802.3af)
- Wall Mount

SIP-T23P/G



Physical Features:

- 132x64 graphic LCD with 4-level grayscales
- 3 VoIP accounts, Broadsoft Validated/Asterisk® Compatible
- HD Voice: HD Codec, HD Handset, HD Speaker
- 31 keys including 4 soft keys
- 1*RJ9 (4P4C) handset port
- 1*RJ9 (4P4C) headset port
- 2*RJ45 10/100/1000Mbps Ethernet ports (1000Mbps is only applicable to SIP-T23G IP phones)
- 5 LEDs: 1*power, 3*line, 1*message
- Power adapter: AC 100~240V input and DC 5V/600mA output
- Power over Ethernet (IEEE 802.3af)
- Wall Mount

SIPT21(P) E2



Physical Features:

- 132x64 graphic LCD
- 2 VoIP accounts, Broadsoft Validated/Asterisk® Compatible
- 30 keys including 4 soft keys
- 4 LEDs: 1*power, 2*line, 1*message
- HD Voice: HD Codec, HD Handset, HD Speaker
- 1xRJ9 (4P4C) handset port
- 1xRJ9 (4P4C) headset port
- 2xRJ45 10/100Mbps Ethernet ports
- Power adapter: AC 100~240V input and DC 5V/600mA output
- Power over Ethernet (IEEE 802.3af) (not applicable to SIPT21 E2 IP phones)
- Wall Mount

SIP-T19(P) E2



Physical Features:

- 132x64 graphic LCD
- Single VoIP account, Broadsoft Validated/Asterisk® Compatible
- 28 keys including 4 soft keys
- 1 LED: 1*power
- HD Voice: HD Codec, HD Handset, HD Speaker
- 1xRJ9 (4P4C) handset port
- 1xRJ9 (4P4C) headset port
- 2xRJ45 10/100Mbps Ethernet ports
- Power adapter: AC 100~240V input and DC 5V/600mA output
- Power over Ethernet (IEEE 802.3af) (not applicable to SIP-T19 E2 IP phones)
- Wall Mount

Key Features of IP Phones

In addition to physical features introduced above, IP phones also support the following key features when running the latest firmware:

- **Phone Features**
 - **Call Options:** emergency call, call waiting, call hold, call mute, call forward, call transfer, call pickup, conference.
 - **Basic Features:** DND, auto redial, live dialpad, dial plan, hotline, caller identity, auto answer.
 - **Advanced Features:** BLF, server redundancy, distinctive ring tones, remote phone book, LDAP.
- **Codecs and Voice Features**
 - Wideband codec: G.722
 - Narrowband codec: G.711, G.726, G.729, iLBC, G723 (G723 is not applicable to SIP-T27P, SIP-T23P/G, SIP-T21(P) E2 and SIP-T19(P) E2 IP phones)
 - VAD, CNG, AEC, PLC, AJB, AGC
 - Full-duplex speakerphone with AEC
- **Network Features**
 - SIP v1 (RFC 2543), v2 (RFC 3261)
 - NAT Traversal: STUN mode
 - DTMF: INBAND, RFC 2833, SIP INFO
 - Proxy mode and peer-to-peer SIP link mode
 - IP assignment: Static/DHCP/PPPoE (PPPoE is not applicable to SIP-T42G/T41P IP phones)
 - VLAN assignment: LLDP/Static/DHCP/CDP
 - Bridge mode for PC port
 - HTTP/HTTPS server
 - DNS client
 - NAT/DHCP server
 - IPv6 support
- **Management**
 - FTP/TFTP/HTTP/PnP auto-provision
 - Configuration: browser/phone/auto-provision
 - Direct IP call without SIP proxy
 - Dial number via SIP server
 - Dial URL via SIP server
 - TR-069

- **Security**
 - HTTPS (server/client)
 - SRTP (RFC 3711)
 - Transport Layer Security (TLS)
 - VLAN (802.1q), QoS
 - Digest authentication using MD5/MD5-sess
 - Secure configuration file via AES encryption
 - Phone lock for personal privacy protection
 - Admin/User configuration mode
 - 802.1X authentication

Expansion Module

This section introduces EXP38, EXP39 and EXP40 expansion modules. EXP38 and EXP39 are only applicable to SIP-T29G and SIP-T27P IP phones. EXP40 is only applicable to SIP-T48G and SIP-T46G IP phones.

EXP38



Physical Features:

- 38 physical keys each with a dual-color LED
- Daisy-chain 6 modules up to 228 keys
- Power adapter: AC 100~240V input and DC 5V/1.2A output

- 2*RJ-12 (6P6C) ports for data in and out

EXP39



Physical Features:

- Rich visual experience with 160 x 320 graphic LCD
- 20 physical keys each with a dual-color LED
- 20 additional keys through page switch
- Daisy-chain 6 modules up to 120 keys
- Power adapter: AC 100~240V input and DC 5V/1.2A output
- 2*RJ-12 (6P6C) ports for data in and out

EXP40



Physical Features:

- Rich visual experience with 160 x 320 graphic LCD
- 20 physical keys each with a dual-color LED
- 20 additional keys through page switch
- Supports up to 6 modules daisy-chain
- Power adapter: AC 100~240V input and DC 5V/1.2A output
- 2*RJ-12 (6P6C) ports for data in and out
- Wall Mount

Getting Started

This chapter provides basic information and installation instructions of SIP-T48G/T46G/T42G/T41P/T29G/T27P/T23P/T23G/T21(P) E2/T19(P) E2 IP phones.

This chapter provides the following sections:

- [Connecting the IP Phones](#)
- [Initialization Process Overview](#)
- [Verifying Startup](#)
- [Reading Icons](#)
- [Configuration Methods](#)
- [Obtaining Configuration Files and Resource Files](#)
- [Keep User Personalized Settings](#)
- [Provisioning Server](#)
- [Configuring Basic Network Parameters](#)
- [Upgrading Firmware](#)

Connecting the IP Phones

This section introduces how to install SIP-T48G/T46G/T42G/T41P/T29G/T27P/T23P/T23G/T21(P) E2/T19(P) E2 IP phones with components in packaging contents.

1. Attach the stand and the optional wall mount bracket
2. Connect the handset and optional headset
3. Connect the network and power

Note

A headset, wall mount bracket are not included in packaging contents.

1) Attach the stand and the optional wall mount bracket:

For SIP-T48G:

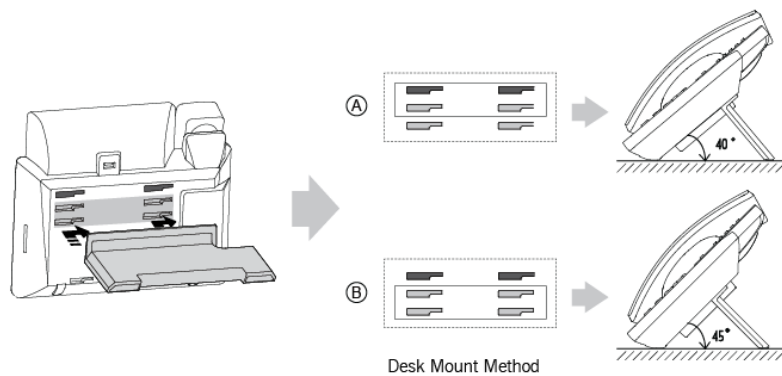

Desk Mount Method

Desk Mount Method

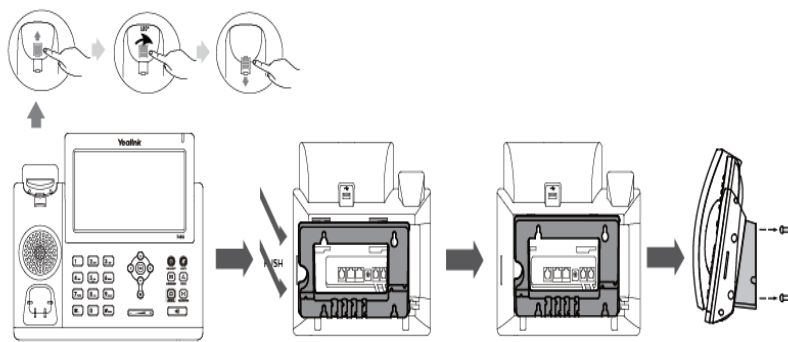

Wall Mount Method (Optional)

Note The top two slots on SIP-T48G IP phones are plugged up by silica gel. You need to pull out silica gel before attaching the wall mount bracket.

For SIPT46G:

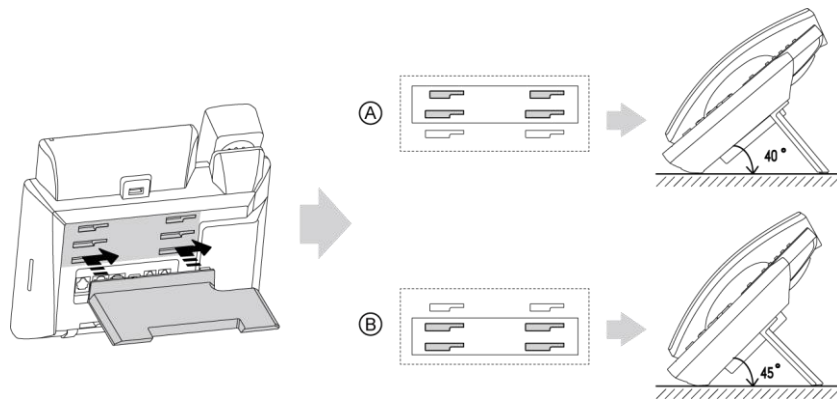

Desk Mount Method

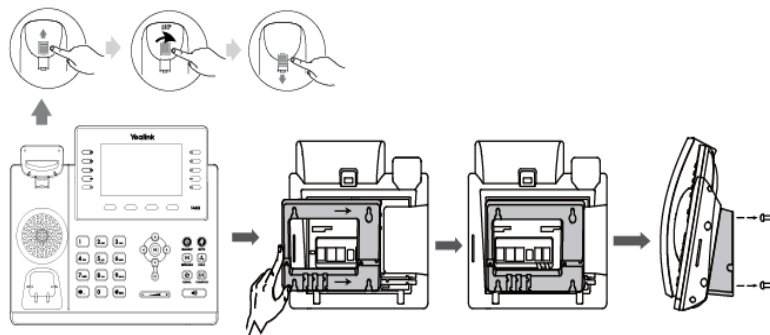

Wall Mount Method (Optional)

For SIP-T42G/T41P:

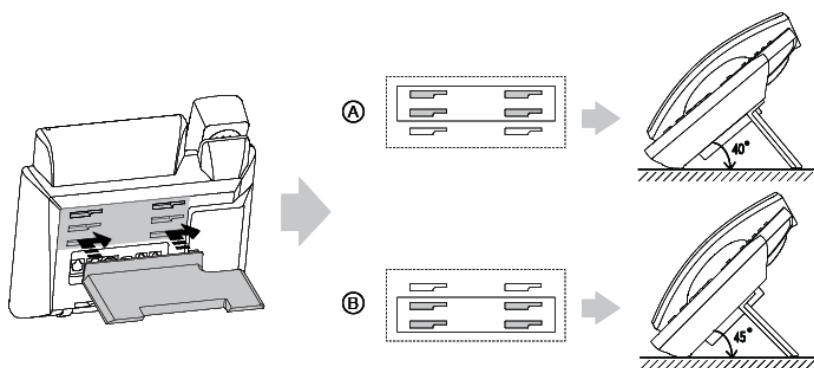

Desk Mount Method

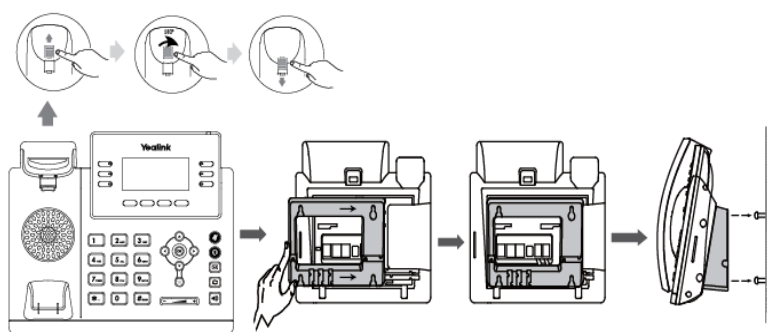

Wall Mount Method (Optional)

For SIP-T29G/T27P:

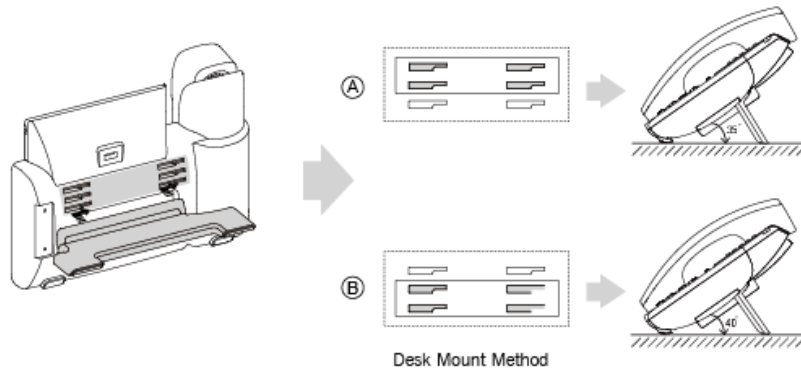

Desk Mount Method

Desk Mount Method

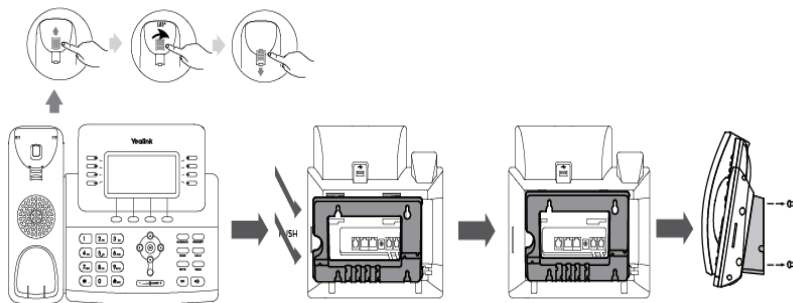

Wall Mount Method (Optional)

For SIP-T23P/T23G:

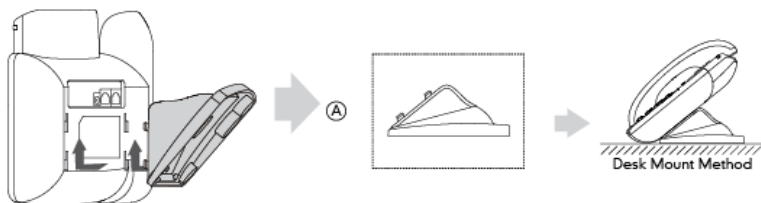

Desk Mount Method

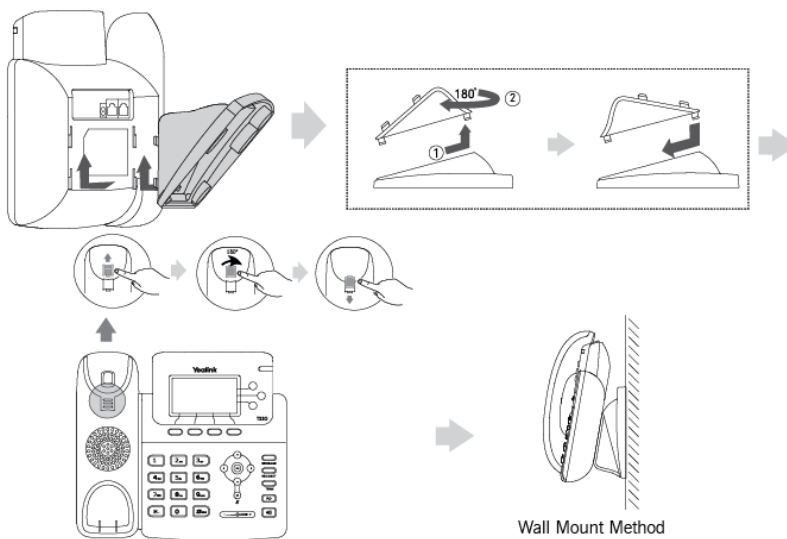

Wall Mount Method (Optional)

For SIP-T21(P) E2:

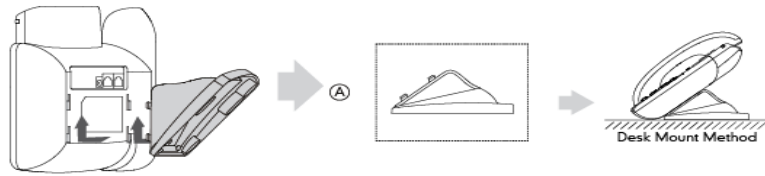

Desk Mount Method

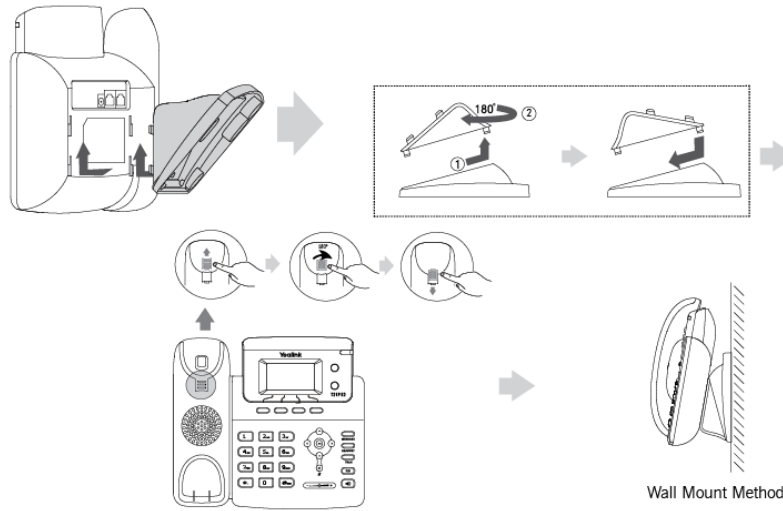

Wall Mount Method (Optional)

For SIP-T19(P) E2:

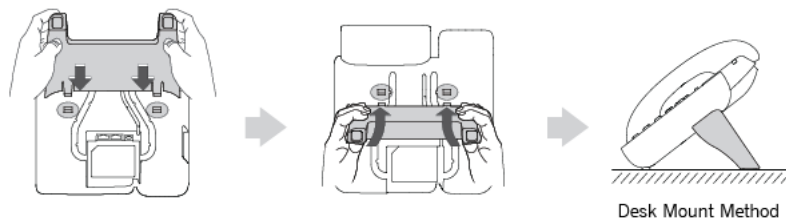

Desk Mount Method

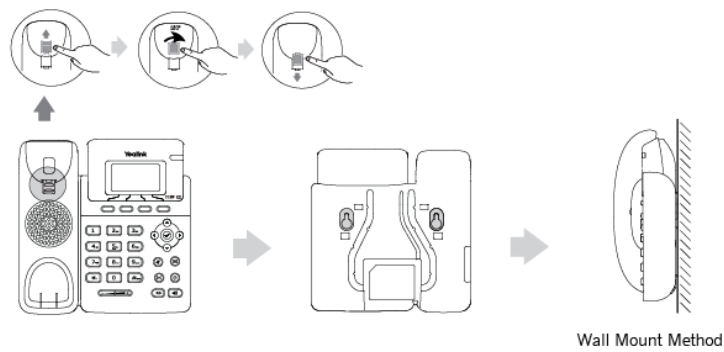

Wall Mount Method (Optional)

Note

The hookswitch tab has a lip which allows the handset to stay on-hook when the IP phone is mounted vertically.
For more information on how to mount the IP phone to a wall, refer to [Yealink Wall Mount Quick Installation Guide](#).

2) Connect the handset and optional headset:

For SIP-T48G/T46G/T29G:

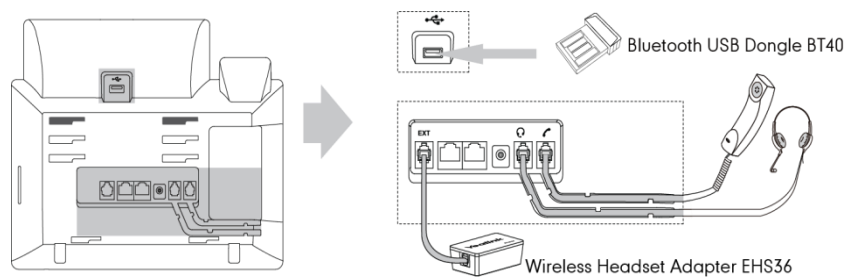

For SIP-T42G/T41P:

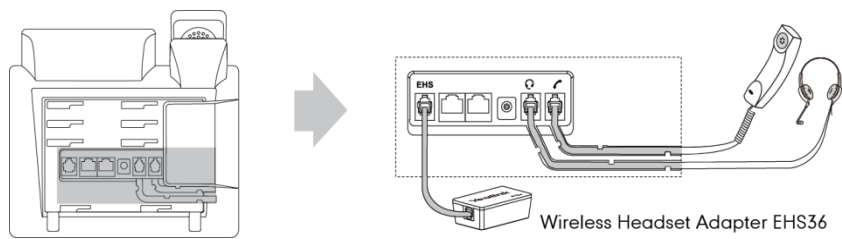

For SIP-T27P:

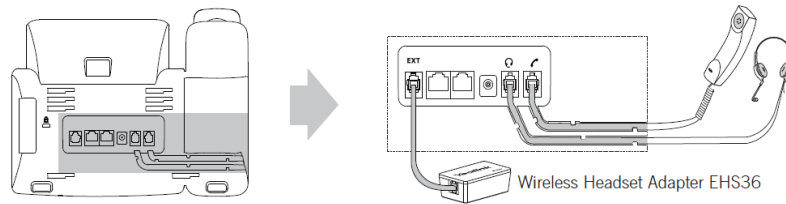

Note

Wireless headset adapter EHS36 and Bluetooth USB dongle BT40 should be purchased separately.

For more information on how to use the EHS36 on the IP phone, refer to [Yealink EHS36 User Guide](#).

Bluetooth can only be used on the SIP-T48G/T46G/T29G IP phones. For more information on how to use the Bluetooth on SIP-T48G/T46G/T29G IP phones, refer to [Yealink Bluetooth USB Dongle BT40 User Guide](#).

The EXT port on SIP-T48G and SIP-T46G IP phones can also be used to connect the expansion module EXP40. The EXT port on SIP-T29G/T27P IP phones can also be used to connect the expansion module EXP38/EXP39. For more information on how to connect the EXP40/EXP39/EXP38, refer to [Yealink EXP40 User Guide](#)/[Yealink EXP39 User Guide](#)/[Yealink EXP38 User Guide](#).

For SIP-T23P/T23G/T21(P) E2:

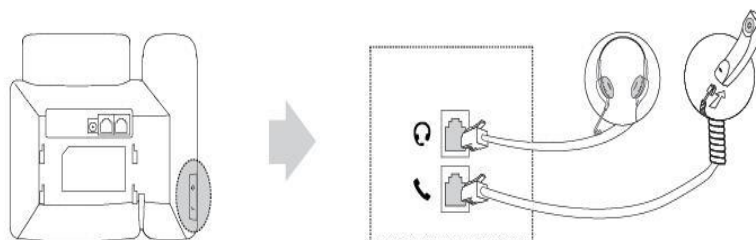

For SIP-T19(P) E2:

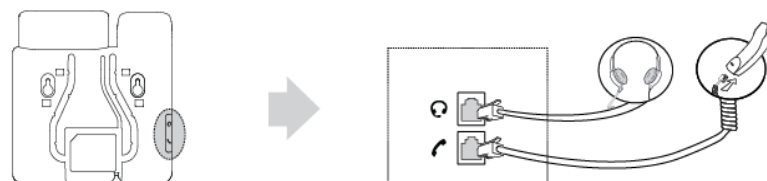

3) Connect the network and power:

- AC power (Optional)
- Power over Ethernet (PoE)

Note

PoE is not applicable to the SIP-T21 E2 and SIP-T19 E2 IP phones.

AC Power (Optional)

To connect the AC power and network:

1. Connect the DC plug of the power adapter to the DC5V port on the IP phone and connect the other end of the power adapter into an electrical power outlet.
2. Connect the included or a standard Ethernet cable between the Internet port on the IP phone and the one on the wall or switch/hub device port.

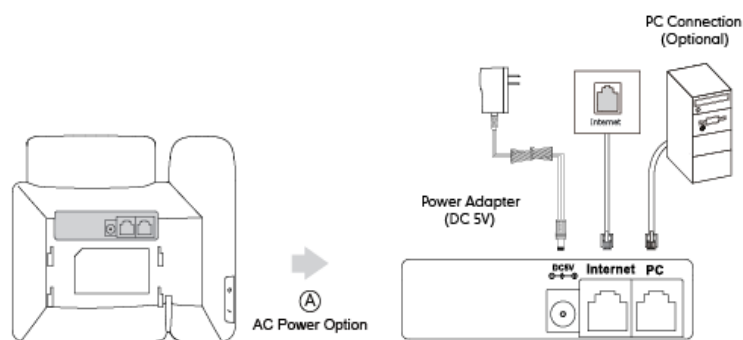

Power over Ethernet

With the included or a regular Ethernet cable, IP phones can be powered from a PoE-compliant switch or hub.

To connect the PoE:

1. Connect the Ethernet cable between the Internet port on the IP phone and an available port on the in-line power switch/hub.

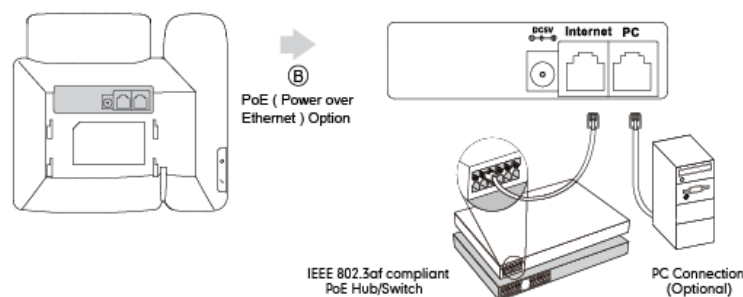
**Note**

If in-line power switch/hub is provided, you don't need to connect the phone to the power adapter. Make sure the switch/hub is PoE-compliant.

The IP phone can also share the network with another network device such as a PC (personal computer). It is an optional connection.

Important! Do not unplug or remove the power while the IP phone is updating firmware and configurations.

Initialization Process Overview

The initialization process of the IP phone is responsible for network connectivity and operation of the IP phone in your local network.

Once you connect your IP phone to the network and to an electrical supply, the IP phone begins its initialization process.

During the initialization process, the following events take place:

Loading the ROM file

The ROM file resides in the flash memory of the IP phone. The IP phone comes from the factory with a ROM file preloaded. During initialization, the IP phone runs a bootstrap loader that loads and executes the ROM file.

Configuring the VLAN

If the IP phone is connected to a switch, the switch notifies the IP phone of the VLAN information defined on the switch (if using LLDP or CDP). The IP phone can then proceed with the DHCP request for its network settings (if using DHCP).

Querying the DHCP (Dynamic Host Configuration Protocol) Server

The IP phone is capable of querying a DHCP server. DHCP is enabled on the IP phone by default. The following network parameters can be obtained from the DHCP server during initialization:

- IP Address
- Subnet Mask
- Gateway
- Primary DNS (Domain Name Server)
- Secondary DNS

You need to configure network parameters of the IP phone manually if any of them is not supplied by the DHCP server. For more information on configuring network parameters manually, refer to [Configuring Network Parameters Manually](#) on page 67.

Contacting the provisioning server

If the IP phone is configured to obtain configurations from the provisioning server, it will connect to the provisioning server and download the configuration file(s) during startup. The IP phone will be able to resolve and update configurations written in the configuration file(s). If the IP phone does not obtain configurations from the provisioning server, the IP phone will use configurations stored in the flash memory.

Updating firmware

If the access URL of firmware is defined in the configuration file, the IP phone will download firmware from the provisioning server. If the MD5 value of the downloaded firmware file differs from that of the image stored in the flash memory, the IP phone will perform a firmware update.

Downloading the resource files

In addition to configuration file(s), the IP phone may require resource files before it can deliver service. These resource files are optional, but if some particular features are being deployed, these files are required.

The followings show examples of resource files:

- Language packs
- Ring tones
- Contact files

Verifying Startup

After connected to the power and network, the IP phone begins the initializing process by cycling through the following steps:

























































1. The power indicator LED illuminates green.





























































2. The message “Welcome Initializing... please wait” appears on the LCD screen when the IP phone starts up.
3. The main LCD screen displays the following:
 - Time and date
 - Soft key labels
4. Press the OK/√ key to check the IP phone status, the LCD screen displays the valid IP address, MAC address, firmware version, etc.

If the IP phone has successfully passed through these steps, it starts up properly and is ready for use.













































Reading Icons

































Icons associated with different features may appear on the LCD screen. The following table provides a description for each icon on IP phones.

































T48G	T46G	T42G/T41P	T29G	T27P	T23P/T23G /T21(P) E2	T19(P) E2	Description
							Network is unavailable.
							Private line registers successfully.
							Registration failed
 (Flashing)							Registering
							Hands-free speakerphone mode
							Handset mode
							Headset mode
							Voice Mail









































T48G	T46G	T42G/T41P	T29G	T27P	T23P/T23G /T21(P) E2	T19(P) E2	Description
		/					Text Message
		AA					Auto Answer
		DND					Do Not Disturb
							Call Forward
							Call Hold
							Call Mute
							Ringer volume is 0
							Phone Lock
							Multi-lingual lowercase letters input method

































T48G	T46G	T42G/T41P	T29G	T27P	T23P/T23G /T21(P) E2	T19(P) E2	Description
							Multi-lingual uppercase letters input method
							Alphanumeric input method
							Numeric input method
							Multi-lingual uppercase and lowercase letters input method
							Received Calls
							Placed Calls
							Missed Calls
							Forwarded Calls
							Recording box is full
							A call cannot be recorded

T48G	T46G	T42G/T41P	T29G	T27P	T23P/T23G /T21(P) E2	T19(P) E2	Description
							Recording starts successfully
							Recording cannot be started
							Recording cannot be stopped
		VPN		VPN	VPN	/	VPN is enabled
		/		/	/	/	Bluetooth mode is on
		/		/	/	/	Bluetooth headset is both paired and connected
/		/		/	/	/	Conference
							The default contact icon
		/		/	/	/	The default caller photo
		/		/	/	/	Line is seized (line key type is Line)

T48G	T46G	T42G/T41P	T29G	T27P	T23P/T23G /T21(P) E2	T19(P) E2	Description
		/		/	/	/	Line key type is Speed Dial
		/		/	/	/	BLF/BLF list idle state (line key type is BLF/BLF List)
		/		/	/	/	BLF/BLF list ringing state (line key type is BLF/BLF List)
		/		/	/	/	BLF/BLF list hold state (line key type is BLF/BLF List)
		/		/	/	/	BLF/BLF list calling state (line key type is BLF/BLF List)
		/		/	/	/	BLF/BLF list failed state (line key type is BLF/BLF List)
		/		/	/	/	BLF/BLF list call park state (line key type is BLF/BLF List)
		/		/	/	/	Line key type is Voice Mail
		/		/	/	/	Line key type is Group Pickup
		/		/	/	/	Park successfully/Call park idle state (line key type is Call Park)
		/		/	/	/	Call park ringing state (line key type is Call Park)

T48G	T46G	T42G/T41P	T29G	T27P	T23P/T23G /T21(P) E2	T19(P) E2	Description
		/		/	/	/	Park failed
		/		/	/	/	Line key type is Intercom
		/		/	/	/	Line key type is DTMF/Prefix
		/		/	/	/	Line key type is Local Group/XML Group
		/		/	/	/	Line key type is XML Brower
		/		/	/	/	Line key type is LDAP
		/		/	/	/	Line key type is Conference
		/		/	/	/	Line key type is Forward
		/		/	/	/	Line key type is Transfer
		/		/	/	/	Line key type is Hold
		/		/	/	/	Line key type is DND

T48G	T46G	T42G/T41P	T29G	T27P	T23P/T23G /T21(P) E2	T19(P) E2	Description
		/		/	/	/	Line key type is Recall
		/		/	/	/	Line key type is SMS
		/		/	/	/	Line key type is Record/URL Record
		/		/	/	/	A recording is started (Line key type is Record/URL Record)
		/		/	/	/	Line key type is Multicast Paging/Group Listening
		/		/	/	/	Line key type is Hot Desking
		/		/	/	/	Line key type is Zero Touch
		/		/	/	/	Line key type is URL
		/		/	/	/	Line key type is Phone Lock
							The ACD state is available
		 and x		 and x	 and x	 and x	The ACD state is unavailable

T48G	T46G	T42G/T41P	T29G	T27P	T23P/T23G /T21(P) E2	T19(P) E2	Description
							The ACD state is Wrap up
							Log out of the ACD system
							The shared line/bridged line is idle
		/		/	/	/	The shared line receives ring-back tone
		/		/	/	/	The shared line receives an incoming call
		/		/	/	/	The shared line is in conversation
		/		/	/	/	The shared line conversation is placed on public hold

Configuration Methods

IP phones can be configured automatically through configuration files stored on a central provisioning server, manually via phone user interface or web user interface, or by a combination of the automatic and manual methods.

The recommended method for configuring IP phones is automatically through a central provisioning server. If a central provisioning server is not available, the manual method will allow changes to most features.

The following sections describe how to configure IP phones using each method.

- [Phone User Interface](#)
- [Web User Interface](#)
- [Configuration Files](#)

Phone User Interface

An administrator or a user can configure and use IP phones via phone user interface. Access to specific features is restricted to the administrator. The default password is "admin" (case-sensitive). Not all features are available on phone user interface. For more information, refer to [Yealink phone-specific user guide](#).

Web User Interface

An administrator or a user can configure IP phones via web user interface. The default user name and password for the administrator to log into the web user interface are both "admin" (case-sensitive). Most features are available for configuring via web user interface. IP phones support both HTTP and HTTPS protocols for accessing the web user interface. For more information, refer to [Web Server Type](#) on page 126.

Configuration Files

An administrator can deploy and maintain a mass of IP phones using configuration files. The configuration files consist of:

- Common CFG file
- MAC-Oriented CFG file
- MAC-local CFG file

Common CFG file

A Common CFG file contains parameters that affect the basic operation of the IP phone, such as language and volume. It will be effectual for all IP phones of the same model.

The common CFG file has a fixed name for each IP phone model. The name of the Common CFG file for each IP phone model is:

- SIP-T48G: y000000000035.cfg
- SIP-T46G: y000000000028.cfg
- SIP-T42G: y000000000029.cfg
- SIP-T41P: y000000000036.cfg
- SIP-T29G: y000000000046.cfg
- SIP-T27P: y000000000045.cfg
- SIP-T23P/G: y000000000044.cfg
- SIP-T21(P) E2: y000000000052.cfg
- SIP-T19(P) E2: y000000000053.cfg

MAC-Oriented CFG file

A MAC-Oriented CFG file contains parameters unique to a particular phone. It will only be effectual for a specific IP phone. The MAC-Oriented CFG file is named after the MAC address of the IP phone. For example, if the MAC address of an IP phone is 00156574B150, the name of the MAC-Oriented CFG file must be 00156574b150.cfg (case-sensitive).

MAC-local CFG file

A MAC-local CFG file contains changes that users make via web user interface and phone user interface. It will only be effectual for a specific IP phone. The MAC-local CFG file is named after the MAC address of the IP phone. This file is stored locally on the IP phone and can also be uploaded to the provisioning server.

Most configurations made by users via web user interface and phone user interface can be saved to the <MAC>-local.cfg file, but some configurations listed as below are defined never to be saved to the <MAC>-local.cfg file:

- Configurations associated with the password.
For example,
`#Configure the password for PPPoE connection.`
`network.pppoe.password =`
- Configurations requiring a reboot during auto provisioning.
For example,
`#Configure the IP address mode.`
`network.ip_address_mode =`
- The following specified configurations.
`#Configure always forward feature.`
`forward.always.enable =`

```

forward.always.target =
forward.always.on_code =
forward.always.off_code =
#Configure busy forward feature.
forward.busy.enable =
forward.busy.target =
forward.busy.on_code =
forward.busy.off_code =
#Configure no answer forward feature.
forward.no_answer.enable =
forward.no_answer.target =
forward.no_answer.timeout =
forward.no_answer.on_code =
forward.no_answer.off_code =
#Configure DND feature.
features.dnd.enable =
features.dnd.on_code =
features.dnd.off_code =
#Configure always forward feature for account X. (X stands for the serial number
of account)
account.X.always_fwd.enable =
account.X.always_fwd.target =
account.X.always_fwd.on_code =
account.X.always_fwd.off_code =
#Configure busy forward feature for account X. (X stands for the serial number of
account)
account.X.busy_fwd.enable =
account.X.busy_fwd.target =
account.X.busy_fwd.on_code =
account.X.busy_fwd.off_code =
#Configure no answer forward feature for account X. (X stands for the serial
number of account)
account.X.timeout_fwd.enable =
account.X.timeout_fwd.target =
account.X.timeout_fwd.timeout =
account.X.timeout_fwd.on_code =
account.X.timeout_fwd.off_code =

```



```

#Configure DND feature for account X. (X stands for the serial number of account)
account.X.dnd.enable =
account.X.dnd.on_code =
account.X.dnd.off_code =
#Configure the access URL of the firmware file.
firmware.url =
#Configure the access URL of configuration files.
auto_provision.server.url=

```

The following configurations are defined to be bundled together. If a user modifies one of the configurations in a group via web user interface and phone user interface, the other configurations in this group can also be saved to the <MAC>-local.cfg file (if the configuration value is blank, write "%NULL%" into the configuration) in addition to the modified configuration.

```

#Group1: Configure line key. (Line key is not applicable to SIP-T19(P) E2 IP phones. X
stands for the serial number of line key)
linekey.X.line =
linekey.X.value =
linekey.X.pickup_value =
linekey.X.type =
linekey.X.xml_phonebook =
linekey.X.label =
#Group2: Configure programable key. (X stands for the serial number of programable
key)
programablekey.X.type =
programablekey.X.line =
programablekey.X.value =
programablekey.X.xml_phonebook =
programablekey.X.history_type =
programablekey.X.label =
#Group3: Configure expansion module key. (Expansion module key is only applicable
to the SIP-T48G/T46G/T29G/T27P IP phones. X stands for the serial number of expansion
module, Y stands for the serial number of expansion key)
expansion_module.X.key.Y.type =
expansion_module.X.key.Y.line =
expansion_module.X.key.Y.value =
expansion_module.X.key.Y.pickup_value =
expansion_module.X.key.Y.label =
expansion_module.X.key.Y.xml_phonebook =

```

The MAC-local CFG file enables the phone to keep user personalized settings. For more information on how to keep user personalized settings, refer to [Keep User Personalized Settings](#) on page 45.

Central Provisioning

IP phones can be centrally provisioned from a provisioning server using the configuration files (<y0000000000xx>.cfg and <MAC>.cfg). You can use a text-based editing application to edit configuration files, and then store configuration files to a provisioning server. For more information on the provisioning server, refer to [Provisioning Server](#) on page 56.

IP phones can obtain the provisioning server address during startup. Then IP phones download configuration files from the provisioning server, resolve and update the configurations written in configuration files. This entire process is called auto provisioning. For more information on auto provisioning, refer to [Yealink_SIP-T2_Series_T19\(P\)_E2_T4_Series_IP_Phones_Auto_Provisioning_Guide](#).

Obtaining Configuration Files and Resource Files

When configuring particular features, you may need to upload resource files (e.g., local contact directory, remote phone book) to IP phones. If the resource file is to be used for all IP phones of the same model, the resource file access URL is best specified in the <y0000000000xx>.cfg file. However, if you want to specify the desired phone to use the resource file, the resource file access URL should be specified in the <MAC>.cfg file.

The names of the Yealink-supplied template files are:

Template File		File Name
Configuration Files	Common CFG file	Common.cfg
	MAC-Oriented CFG file	MAC.cfg
Resource Files	AutoDST Template	AutoDST.xml
	Language Packs	For example, 000.GUI.English.lang 1.English_note.xml 1.English.js
	Input Method File	ime.txt
	Replace Rule Template	dialplan.xml
	Dial-now Template	dialnow.xml

Template File		File Name
	Softkey Layout Template	CallFailed.xml CallIn.xml Connecting.xml Dialing.xml (not applicable to SIP-T48G) RingBack.xml Talking.xml
	Directory Template	favorite_setting.xml
	Super Search Template	super_search.xml
	Local Contact File	contact.xml
	Remote Phone Book Template	Department.xml Menu.xml

You can ask the distributor or Yealink FAE for template files. You can also obtain the template files online:

<http://support.yealink.com/documentFront/forwardToDocumentFrontDisplayPage>.

To download template files:

1. Go to Yealink [Document Download](#) Page and select the desired phone model.
2. Download and extract the combined configuration files to your local system.

The following illustration shows the template files available for SIP-T48G IP phones running firmware version 73.

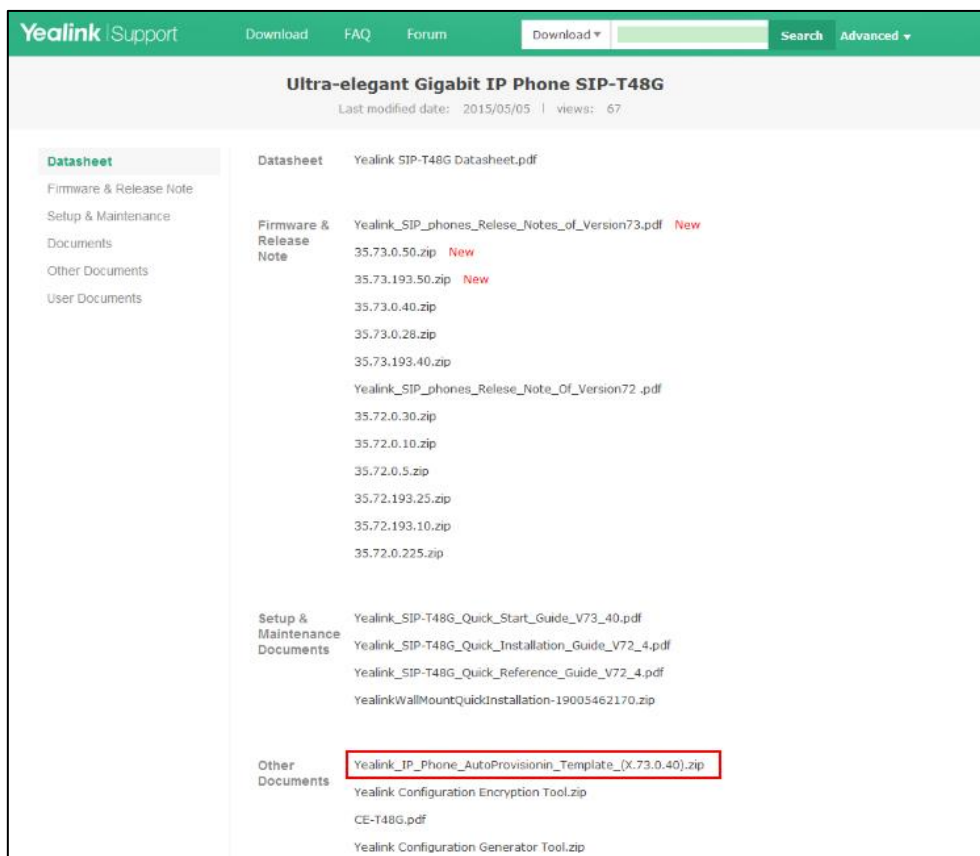

- Open the folder you extracted and identify the template file you will edit according to the table introduced above.

For some features, you can customize the filename as required. The following table lists the special characters supported by Yealink IP phones:

Platform \ Server	HTTP/HTTPS	TFTP/FTP
Windows	<p>Support: ~ ` ! @ \$ ^ () _ - , . ' ; [] { } (including space)</p> <p>Not Support: < > : " / \ * ? # % & = +</p>	<p>Support: ~ ` ! @ \$ ^ () _ - , . ' ; [] { } % & = + (including space)</p> <p>Not Support: < > : " / \ * ? #</p>
Linux	<p>Support: ~ ` ! @ \$ ^ () _ - , . ' ; [] { } < > : " (including space)</p> <p>Not Support: / \ * ? # % & = +</p>	<p>Support: ~ ` ! @ \$ ^ () _ - , . ' ; [] { } < > : " % & = + (including space)</p> <p>Not Support: / \ * ? #</p>

Keep User Personalized Settings

Generally, the administrator deploys phones in batch via auto provisioning, yet some users would like to keep the personalized settings (e.g., ringtones, dial plan and DSS keys), after auto provisioning. These specific scenarios are applicable to SIP-T48G/T46G/T42G/T41P/T29G/T27P/T23P/T23G/T21(P) E2/T19(P) E2 IP phones running firmware version 80 or later. The following demonstrated specific scenarios are taking SIP-T46G/T23G IP phones as example for reference.

Note

Yealink IP phones support FTP, TFTP, HTTP and HTTPS protocols for uploading the MAC-local CFG file. This section takes the TFTP protocol as an example. Before performing the following, make sure the provisioning server supports uploading.

If you are using the HTTP/HTTPS server, you can specify the way the IP phone uploads the MAC-local CFG file to the provisioning server. It is determined by the value of the parameter "auto_provision.custom.upload_method".

Configuration Parameters

The following table lists the configuration parameters used to determine the phone behavior for keeping user personalized settings:

Parameters	Permitted Values	Default
auto_provision.custom.protect	0 or 1	0
<p>Description: Enables or disables the IP phone to keep user personalized settings after auto provisioning.</p> <p>0-Disabled 1-Enabled</p> <p>If it is set to 1 (Enabled), personalized settings configured via web or phone user interface will be kept after auto provisioning.</p> <p>Web User Interface: None</p> <p>Phone User Interface: None</p>		
auto_provision.custom.sync	0 or 1	0
<p>Description: Enables or disables the IP phone to periodically (every 5 minutes) upload the</p>		

Parameters	Permitted Values	Default
<p><MAC>-local.cfg file to the provisioning server, and download the <MAC>-local.cfg file from the provisioning server during auto provisioning.</p> <p>0-Disabled 1-Enabled</p> <p>If it is set to 1 (Enabled), the IP phone will periodically upload the <MAC>-local.cfg file to the provisioning server to back up this file. During auto provisioning, the IP phone will download the <MAC>-local.cfg file from the provisioning server to override the one stored on the phone.</p> <p>If it is set to 0 (Disabled), the IP phone will not upload the <MAC>-local.cfg file to the provisioning server. During auto provisioning, the IP phone will not download the <MAC>-local.cfg file from the provisioning server.</p> <p>Web User Interface: None</p> <p>Phone User Interface: None</p>		
auto_provision.custom.upload_method	0 or 1	0
<p>Description:</p> <p>Configures the way the IP phone uploads the <MAC>-local.cfg file to the provisioning server (for HTTP/HTTPS server only).</p> <p>0-PUT 1-POST</p> <p>Note: It works only if the value of the parameter "auto_provision.custom.sync" is set to 1 (Enabled).</p> <p>Web User Interface: None</p> <p>Phone User Interface: None</p>		

For more information on how to configure these parameters in different scenarios, refer to the following introduced scenarios.

Scenario A Keep user personalized configuration settings

Scenario (A) Keep user personalized configuration settings (IP phones are running firmware version prior to X.73.0.1)

The administrator wishes to upgrade firmware from the old version to the latest version. Meanwhile, keep user personalized settings after auto provisioning and upgrade. This scenario is only applicable to SIP-T48G/T46G/T42G/T41P IP phones.

Scenario Conditions:

- The current firmware version of the SIP-T46G IP phone is 28.71.0.181. This firmware version does not support keeping user personalized settings and generating a <MAC>-local.cfg file.
- The target firmware version of the SIP-T46G IP phone is 28.80.0.5. This firmware version supports keeping user personalized settings after auto provisioning or upgrade.
- The MAC address of the SIP-T46G IP phone: 001565221229
- Provisioning server URL: tftp://192.168.1.211
- Place the target firmware to the root directory of the provisioning server.
- Create a new directory "ProvisioningDir_new" under the root directory of the provisioning server.

Note

The IP phone with old firmware does not support keeping user personalized settings after auto provisioning and upgrade. You can configure the value of the parameter "auto_provision.custom.protect" to 1 in the configuration file to keep user personalized settings after auto provisioning and upgrade.

Do the following operations:

1. Place the configuration files (y000000000028.cfg and 001565221229.cfg) that you want the IP phone to download to the new directory "ProvisioningDir_new" of the provisioning server.
2. Add/Edit the following parameter in the y000000000028.cfg file or 001565221229.cfg file you want the IP phone to download:

```
auto_provision.custom.protect = 1
```

3. Create a blank configuration file "y000000000028.cfg" on the root directory of the provisioning server and add the following parameters to this file.

```
firmware.url = tftp://192.168.1.211/28.80.0.5.rom
```

```
auto_provision.server.url = tftp://192.168.1.211/ProvisioningDir_new
```

Note

If your IP phone is running firmware version prior to 61, the IP phone can only recognize the old (M1) configuration file for auto provisioning, so the blank configuration file created above uses the M1 template.

4. Trigger the IP phone to perform the auto provisioning process. For more information on how to trigger auto provisioning process, refer to *Triggering the IP Phone to Perform the Auto Provisioning* section in [Yealink SIP-T2 Series_T19\(P\) E2_T4 Series_IP_Phones_Auto_Provisioning_Guide](#).

During auto provisioning, the IP phone first downloads the y00000000028.cfg file, and then downloads firmware from the root directory of the provisioning server.

The IP phone reboots to complete firmware upgrade, and then starts auto provisioning process again which is triggered by phone reboot (the power on mode is enabled by default). It downloads the y00000000028.cfg and 001565221229.cfg files in sequence from the new directory "ProvisioningDir_new" of the provisioning server. As no 001565221229-local.cfg file exists on the IP phone, the IP phone automatically generates a 001565221229-local.cfg file which saves the personalized settings of the old firmware.

The IP phone updates configurations in the downloaded configuration files orderly to the IP phone system. As the value of the parameter "auto_provision.custom.protect" is set to 1, the phone also updates the configurations stored in the 001565221229-local.cfg file on the phone. As a result, the personalized settings of the old firmware are remained after upgrade and auto provisioning.

Note

If a configuration item is both in the downloaded MAC-local.cfg file and Common CFG file/ MAC-Oriented CFG file, setting of the configuration item in the MAC-local CFG file will be written and saved to the IP phone system.

Scenario (B) Keep user personalized configuration settings (IP phones are running firmware version X.80.0.1 or later)

The administrator wishes to upgrade firmware from the old version to the latest version. Meanwhile, keep user personalized settings after auto provisioning and upgrade.

Scenario Conditions:

- SIP-T23G IP phone current firmware version: 44.80.0.1. This firmware supports keeping personalized settings and generating a <MAC>-local.cfg file.
- SIP-T23G IP phone target firmware version: 44.80.0.5. This firmware supports keeping personalized settings and generating a <MAC>-local.cfg file.

- SIP-T23G IP phone MAC: 001565770984
- Provisioning server URL: tftp://192.168.1.211
- Place the target firmware to the root directory of the provisioning server.

The old firmware version supports keeping personalized settings and generating a <MAC>-local.cfg file. To keep user personalized settings after auto provisioning and upgrade, you need to configure the value of the parameter “auto_provision.custom.protect” to 1 in the configuration file.

Do one of the following operations:

Scenario Operations I:

1. Add/Edit the following parameters in the y000000000044.cfg file or 001565770984.cfg file you want the IP phone to download:

```
auto_provision.custom.protect=1  
  
auto_provision.custom.sync=1  
  
firmware.url = tftp://192.168.1.211/44.80.0.5.rom
```

2. Trigger the IP phone to perform the auto provisioning process. For more information on how to trigger auto provisioning process, refer to *Triggering the IP Phone to Perform the Auto Provisioning* section in [Yealink SIP-T2_Series_T19\(P\) E2_T4_Series_IP_Phones_Auto_Provisioning_Guide](#).

During auto provisioning, the IP phone first downloads the y000000000044.cfg file, and then downloads firmware from the root directory of the provisioning server.

The IP phone reboots to complete firmware upgrade, and then starts auto provisioning process again which is triggered by phone reboot (the power on mode is enabled by default). It downloads the y000000000044.cfg, 001565770984.cfg and the 001565770984-local.cfg file in sequence from the provisioning server, and then updates configurations in these downloaded configuration files orderly to the IP phone system. The IP phone starts up successfully, and the personalized settings in the 001565770984-local.cfg file are kept after auto provisioning.

When a user customizes feature configurations via web/phone user interface, the IP phone will save the personalized configuration settings to the 001565770984-local.cfg file on the IP phone, and then periodically (every 5 minutes) upload this file to the provisioning server.

Note

If a configuration item is both in the downloaded MAC-local.cfg file and Common CFG file/ MAC-Oriented CFG file, setting of the configuration item in the MAC-local CFG file will be written and saved to the IP phone system.

Scenario Operations II:

1. Add/Edit the following parameters in the y000000000044.cfg file or

001565770984.cfg file you want the IP phone to download:

```
auto_provision.custom.protect=1  
auto_provision.custom.sync=0  
firmware.url = tftp://192.168.1.211/44.80.0.5.rom
```

2. Trigger the IP phone to perform the auto provisioning process. For more information on how to trigger auto provisioning process, refer to *Triggering the IP Phone to Perform the Auto Provisioning* section in [Yealink_SIP-T2_Series_T19\(P\)_E2_T4_Series_IP_Phones_Auto_Provisioning_Guide](#).

During auto provisioning, the IP phone first downloads the y000000000044.cfg file, and then downloads firmware from the root directory of the provisioning server.

The IP phone reboots to complete firmware upgrade, and then starts auto provisioning process again which is triggered by phone reboot (the power on mode is enabled by default). It downloads the y000000000044.cfg and 001565770984.cfg files in sequence, and then updates configurations in the downloaded configuration files orderly to the IP phone system. As the value of the parameter "auto_provision.custom.protect" is set to 1, configurations in the 001565770984-local.cfg file saved on the IP phone are also updated.

The IP phone starts up successfully, and personalized settings are kept after auto provisioning. When a user customizes feature configurations via web/phone user interface, the IP phone will save the personalized settings to the 001565770984-local.cfg file on the IP phone only.

Note

In this scenario, the IP phone will not upload the MAC-local.cfg file to provisioning server and request to download the MAC-local.cfg file from provisioning server during auto provisioning.

If a configuration item is both in the MAC-local.cfg file on the IP phone and Common CFG file/ MAC-Oriented CFG file downloaded from auto provisioning server, setting of the configuration item in the MAC-local CFG file will be written and saved to the IP phone system.

If value of the parameter "auto_provision.custom.protect" is set to 0, the personalized settings in the 001565770984-local.cfg file will be overridden after auto provisioning, no matter what the value of the parameter "auto_provision.custom.sync" is.

Note

If a configuration is modified via both web user interface and phone user interface, the later modification will prevail.

For more information on the flowchart of keep user personalized configuration settings, refer to [Appendix E: Auto Provisioning Flowchart \(Keep user personalized configuration settings\)](#) on page 767.

Scenario B Clear user personalized configuration settings

The administrator or user wishes to clear user personalized configuration settings via phone user interface.

Scenario Conditions:

- SIP-T23G IP phone MAC: 001565770984
- The current firmware of the phone is 44.80.0.5 or later.
- Provisioning server URL: tftp://192.168.1.211
- auto_provision.custom.protect = 1

Note

The **Reset Local Configuration** option on the web/phone user interface is available only if the value of the parameter "auto_provision.custom.protect" was set to 1.

If the value of the parameter "auto_provision.custom.sync" was set to 1, the configurations in the 001565770984-local.cfg file on the provisioning server will be also cleared after resetting personalized settings of the phone.

Scenario Operations:

You can clear the personalized settings of the phone via phone or web user interface.

To clear personalized configuration settings via phone user interface:

1. Press **Menu->Settings->Advanced Settings** (default password: admin).
2. Select **Reset Local Configuration**.

The LCD screen prompts "Reset local configurations?".

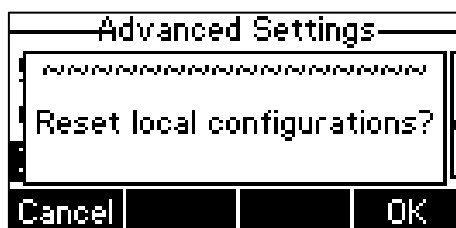

3. Press the **OK** soft key.

The LCD screen prompts "Deleted successfully".

To clear personalized configuration settings via web user interface:

1. Click on **Settings->Upgrade**.
2. Click **Reset Local Config**.

The web user interface prompts "Are you sure to reset the local configuration".

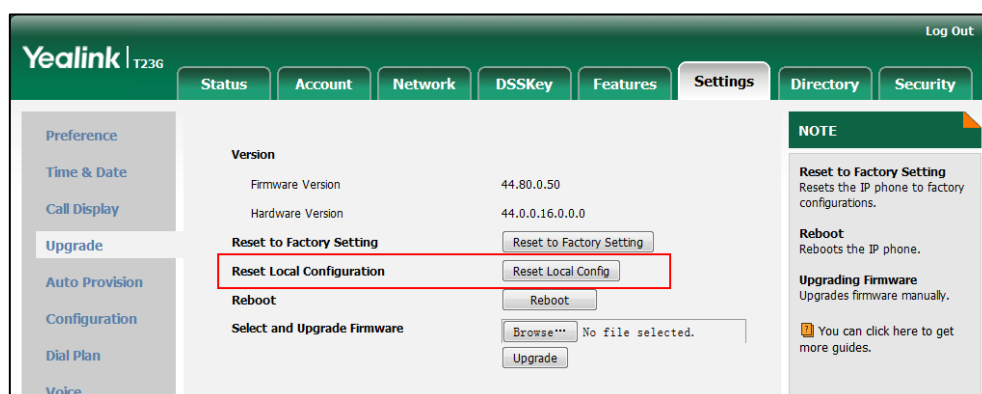

3. Click **OK**.

Configurations in the 001565770984-local.cfg file saved on the phone will be cleared. If the IP phone is triggered to perform auto provisioning after resetting local configuration file, it will download the configuration files from the provisioning server and update the configurations to the phone system. As there is no configuration in the 001565770984-local.cfg file, configurations in the y000000000044.cfg/001565770984.cfg file will take effect.

Scenario C Keep user personalized settings after factory reset

The IP phone requires factory reset when it has a breakdown, but the user wishes to keep personalized settings of the phone after factory reset.

Scenario Conditions:

- SIP-T23G IP phone MAC: 001565770984
- Provisioning server URL: tftp://192.168.1.211
- auto_provision.custom.sync = 1
- auto_provision.custom.protect = 1

Note

As the parameter "auto_provision.custom.sync" was set to 1, the 001565770984-local.cfg file on the IP phone will be uploaded to the provisioning server at tftp://192.168.1.211.

Scenario Operations:

You can keep the personalized settings of the phone after factory reset via phone or web user interface.

To reset the phone to factory via phone user interface:

1. Press **Menu->Settings->Advanced Settings** (default password: admin).
2. Select **Reset to Factory**.

The LCD screen prompts “Reset to factory setting?”.

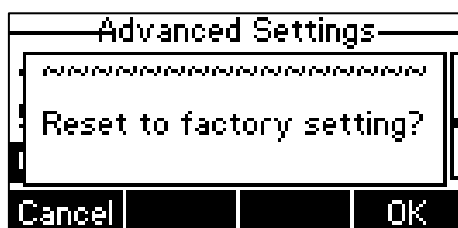

3. Press the **OK** soft key.

The LCD screen prompts “Resetting to factory, please Wait...”.

The LCD screen prompts “Welcome Initializing...please wait”.

To reset the phone to factory via web user interface:

1. Click on **Settings->Upgrade**.
2. Click **Reset to Factory Setting** to reset the phone.

The web user interface prompts “Do you want to reset to factory?”.

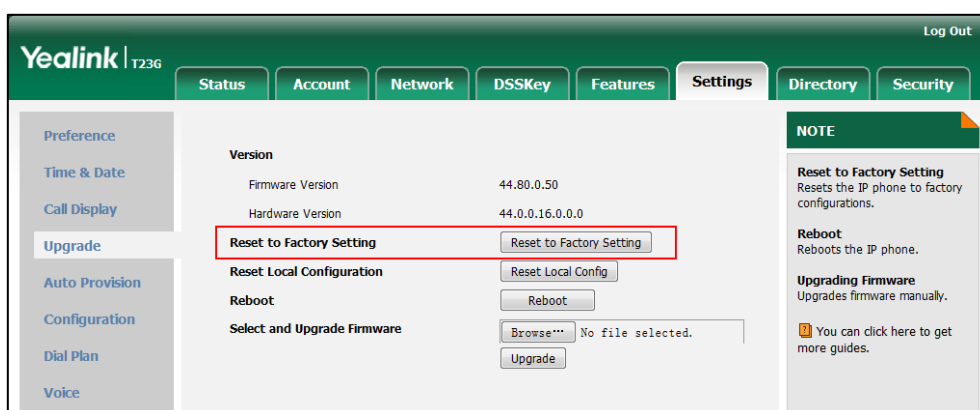

3. Click **OK**.

After startup, all configurations of the phone will be reset to factory defaults.

Configurations in the 001565770984-local.cfg file saved on the IP phone will also be cleared. But configurations in the 001565770984-local.cfg file stored on the provisioning server (tftp://192.168.1.211) will not be cleared after reset.

To retrieve personalized settings of the phone after factory reset:

1. Set the values of the parameters “auto_provision.custom.sync” and “auto_provision.custom.protect” to be 1 in the configuration file (y000000000044.cfg or 001565770984.cfg).
2. Trigger the phone to perform the auto provisioning process.

The IP phone will download the 001565770984-local.cfg file from the provisioning server, and then update configurations in it during auto provisioning. As a result, the personalized settings of the phone are retrieved after factory reset.

Scenario D Import or export the local configuration file

The administrator or user can export the local configuration file to check the personalized settings of the phone configured by the user, or import the local configuration file to configure or change settings of the phone.

Scenario Conditions:

- SIP-T23G IP phone MAC: 001565770984
- The current firmware of the phone is 44.80.0.5 or later.
- Provisioning server URL: tftp://192.168.1.211

Note

As the personalized settings of the base station cannot be changed via auto provisioning when the value of the parameter "auto_provision.custom.protect" is set to 1, it is cautious to change the settings in the <MAC>-local.cfg file before importing it.

Scenario Operations:

To export local configuration file via web user interface:

1. Click on **Settings->Configuration**.
2. Select **Local Configuration** from the pull down list of **Export CFG Configuration File** field, and then click **Export** to open file download window, and then save the 001565770984-local.cfg file to the local system.

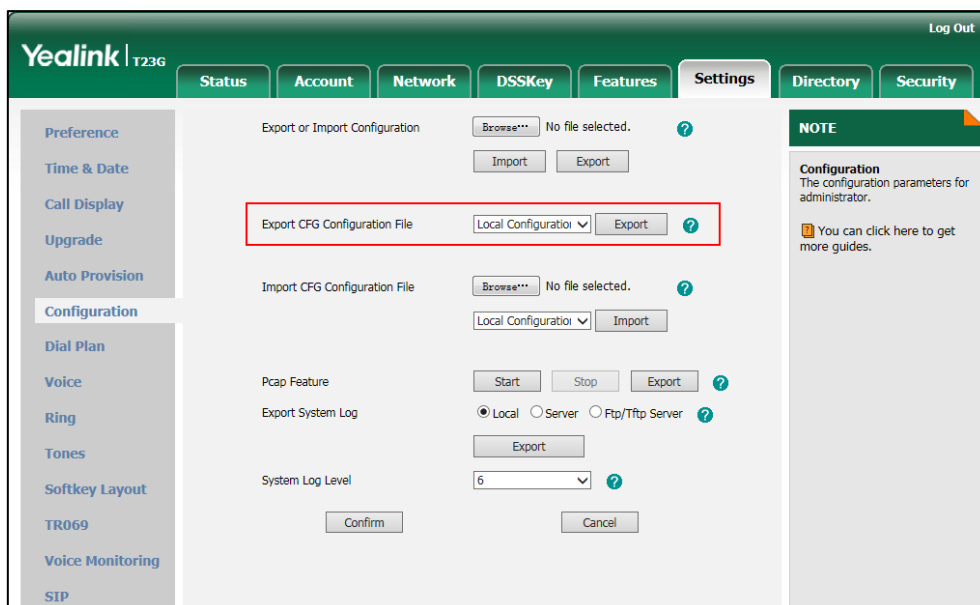

The administrator or user can edit the 001565770984-local.cfg file after exporting.

To import local configuration file via web user interface:

1. Click on **Settings->Configuration**.

- In the **Import CFG Configuration File** field, click **Browse** to locate the 001565770984-local.cfg file from your local system and select **Local Configuration** from the pull down list.

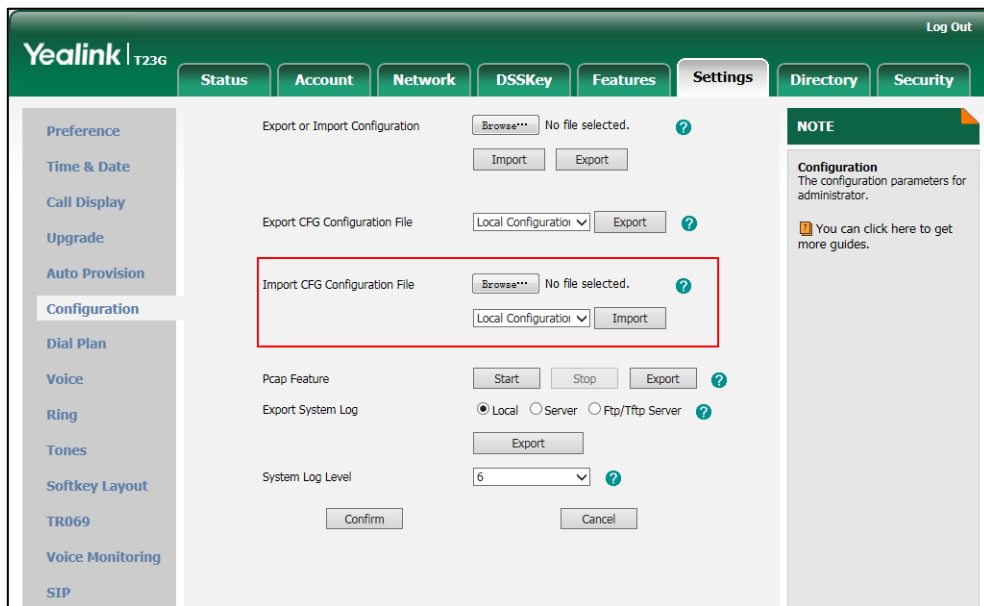

- Click **Import**.

The configurations in the imported 001565770984-local.cfg file will override the one in the existing local configuration file. The configurations only in the existing local configuration file will not be cleared. The configurations in the new 001565770984-local.cfg file will be saved to the phone flash and take effect.

Note

If the value of the parameter "auto_provision.custom.sync" is set to 1, and the 001565770984-local.cfg file is successfully imported, the new 001565770984-local.cfg file will be uploaded to the provisioning server and overrides the existing one on the server.

Provisioning Server

Supported Provisioning Protocols

IP phones perform the auto provisioning function of downloading configuration files, downloading resource files and upgrading firmware. The transfer protocol is used to download files from the provisioning server. IP phones support several transport protocols for provisioning, including FTP, TFTP, HTTP, and HTTPS protocols. And you can specify the transport protocol in the provisioning server address, for example, `http://xxxxxxx`. If not specified, the TFTP protocol is used. The provisioning server address can be IP address, domain name or URL. If a user name and password are specified as part of the provisioning server address, for example, `http://user:pwd@/server/dir`, they will be used only if the server supports them.

Note

A URL should contain forward slashes instead of back slashes and should not contain spaces. Escape characters are not supported.

If a user name and password are not specified as part of the provisioning server address, the User Name and Password of the provisioning server configured on the phone will be used.

There are two types of FTP methods—active and passive. IP phones are not compatible with active FTP.

Setting up the Provisioning Server

The provisioning server can be on the local LAN or anywhere on the Internet. Use the following procedure as a recommendation if this is your first provisioning server setup. For more information on how to set up a provisioning server, refer to [Yealink_SIP-T2_Series_T19\(P\)_E2_T4_Series_IP_Phones_Auto_Provisioning_Guide](#).

To set up the provisioning server:

1. Install a provisioning server application or locate a suitable existing server.
2. Create an account and home directory.
3. Set security permissions for the account.
4. Create configuration files and edit them as desired.
5. Copy the configuration files and resource files to the provisioning server.

For more information on how to deploy IP phones using configuration files, refer to [Deploying Phones from the Provisioning Server](#) on page 57.

Note

Typically all phones are configured with the same server account, but the server account provides a means of conveniently partitioning the configuration. Give each account a unique home directory on the server and change the configuration on a per-line basis.

Deploying Phones from the Provisioning Server

The parameters in the new downloaded configuration files will override the duplicate parameters in files downloaded earlier. During auto provisioning, IP phones download the common configuration file first, and then the MAC-oriented file. Therefore any parameter in the MAC-oriented configuration file will override the same one in the common configuration file.

Yealink supplies configuration files for each phone model, which is delivered with the phone firmware. The configuration files, supplied with each firmware release, must be used with that release. Otherwise, configurations may not take effect, and the IP phone will behave without exception. Before you configure parameters in the configuration files, Yealink recommends that you create new configuration files containing only those parameters that require changes.

To deploy IP phones from the provisioning server:

1. Create per-phone configuration files by performing the following steps:
 - a) Obtain a list of phone MAC addresses (the bar code label on the back of the IP phone or on the outside of the box).
 - b) Create per-phone <MAC>.cfg files by using the MAC-Oriented CFG file from the distribution as templates.
 - c) Edit the parameters in the file as desired.
2. Create new common configuration files by performing the following steps:
 - a) Create <y0000000000xx>.cfg files by using the Common CFG file from the distribution as templates.
 - b) Edit the parameters in the file as desired.
3. Copy configuration files to the home directory of the provisioning server.
4. Reboot IP phones to trigger the auto provisioning process.

IP phones discover the provisioning server address, and then download the configuration files from the provisioning server.

For more information on configuration files, refer to [Configuration Files](#) on page 38. For protecting against unauthorized access, you can encrypt configuration files. For more information on encrypting configuration files, refer to [Encrypting Configuration Files](#) on page 696.

During the auto provisioning process, the IP phone supports the following methods to discover the provisioning server address:

- **Zero Touch:** Zero Touch feature guides you to configure network settings and the provisioning server address via phone user interface after startup.
- **PnP:** PnP feature allows IP phones to discover the provisioning server address by broadcasting the PnP SUBSCRIBE message during startup.
- **DHCP:** DHCP option can be used to provide the address or URL of the provisioning

server to IP phones. When the IP phone requests an IP address using the DHCP protocol, the resulting response may contain option 66 or the custom option (if configured) that contains the provisioning server address.

- **Static:** You can manually configure the server address via phone user interface or web user interface.

For more information on the above methods, refer to [Yealink_SIP-T2_Series_T19\(P\)_E2_T4_Series_IP_Phones_Auto_Provisioning_Guide](#).

Configuring Basic Network Parameters

In order to get your IP phones running, you must perform basic network setup, such as IP address and subnet mask configuration. This section describes how to configure basic network parameters for IP phones.

Note This section mainly introduces IPv4 network parameters. IP phones also support IPv6. For more information on IPv6, refer to [IPv6 Support](#) on page 617.

DHCP

DHCP (Dynamic Host Configuration Protocol) is a network protocol used to dynamically allocate network parameters to network hosts. The automatic allocation of network parameters to hosts eases the administrative burden of maintaining an IP network. IP phones comply with the DHCP specifications documented in RFC 2131. If using DHCP, IP phones connected to the network become operational without having to be manually assigned IP addresses and additional network parameters.

Procedure

DHCP can be configured using the configuration files or locally.

Configuration File	<MAC>.cfg	Configure DHCP on the IP phone. Parameter: network.internet_port.type
Local	Web User Interface	Configure DHCP on the IP phone. Navigate to: http://<phoneIPAddress>/servlet ?p=network&q=load
	Phone User Interface	Configure DHCP on the IP phone.

Details of Configuration Parameters:

Parameters	Permitted Values	Default
network.internet_port.type	0, 1 or 2	0
<p>Description: Configures the Internet (WAN) port type for IPv4.</p> <p>0-DHCP 1-PPPoE (not applicable to SIP-T42G/T41P IP phones) 2-Static IP Address</p> <p>Note: It works only if the value of the parameter "network.ip_address_mode" is set to 0 (IPv4) or 2 (IPv4 & IPv6). If you change this parameter, the IP phone will reboot to make the change take effect.</p> <p>Web User Interface: Network->Basic->IPv4 Config</p> <p>Phone User Interface: Menu->Settings->Advanced Settings (default password: admin) ->Network->WAN Port->IPv4</p>		

To configure DHCP via web user interface:

1. Click on **Network->Basic**.
2. In the **IPv4 Config** block, mark the **DHCP** radio box.

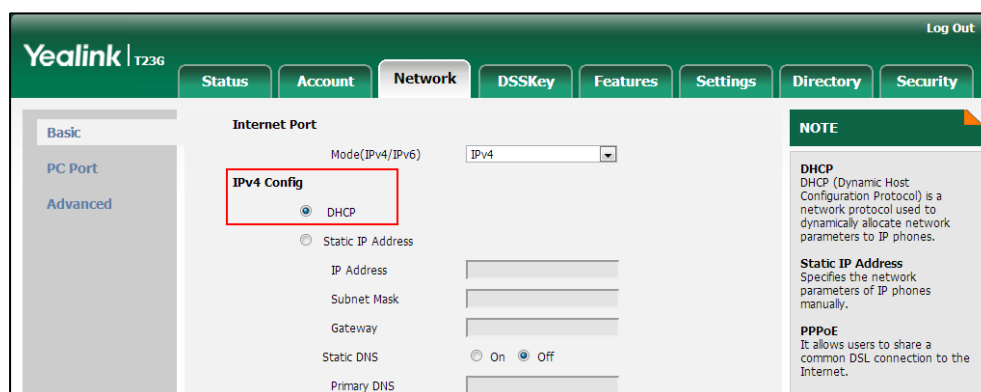

3. Click **Confirm** to accept the change.
A dialog box pops up to prompt that settings will take effect after a reboot.
4. Click **OK** to reboot the phone.

Static DNS

Static DNS address(es) can be configured and used when DHCP is enabled.

Procedure

Static DNS can be configured using the configuration files or locally.

Configuration File	<y0000000000xx>.cfg	Configure the static DNS feature. Parameters: network.static_dns_enable
	<MAC>.cfg	Configure static DNS address. Parameters: network.primary_dns network.secondary_dns
Local	Web User Interface	Configure the static DNS feature. Configure static DNS address. Navigate to: http://<phoneIPAddress>/servlet ?p=network&q=load
	Phone User Interface	Configure the static DNS feature. Configure static DNS address.

Details of Configuration Parameters:

Parameters	Permitted Values	Default
network.static_dns_enable	0 or 1	0
<p>Description: Triggers the static DNS feature to on or off.</p> <p>0-Off 1-On</p> <p>If it is set to 0 (Off), the IP phone will use the IPv4 DNS obtained from DHCP.</p> <p>If it is set to 1 (On), the IP phone will use manually configured static IPv4 DNS.</p> <p>Note: It works only if the value of the parameter "network.internet_port.type" is set to 0 (DHCP). If you change this parameter, the IP phone will reboot to make the change take effect.</p> <p>Web User Interface: Network->Basic->IPv4 Config->Static DNS</p>		

Parameters	Permitted Values	Default
<p>Phone User Interface: Menu->Settings->Advanced Settings (default password: admin)->Network->WAN Port->IPv4->DHCP IPv4 Client->Static DNS</p>		
network.primary_dns	IPv4 Address	Blank
<p>Description: Configures the primary IPv4 DNS server.</p> <p>Example: network.primary_dns = 202.101.103.55</p> <p>Note: It works only if the value of the parameter "network.static_dns_enable" is set to 1 (On). If you change this parameter, the IP phone will reboot to make the change take effect.</p> <p>Web User Interface: Network->Basic->IPv4 Config->Static IP Address->Primary DNS</p> <p>Phone User Interface: Menu->Settings->Advanced Settings (default password: admin) ->Network->WAN Port->IPv4->DHCP IPv4 Client->Static DNS (Enabled) ->IPv4 Pri.DNS</p>		
network.secondary_dns	IPv4 Address	Blank
<p>Description: Configures the secondary IPv4 DNS server.</p> <p>Example: network.secondary_dns = 202.101.103.54</p> <p>Note: It works only if the value of the parameter "network.static_dns_enable" is set to 1 (On). If you change this parameter, the IP phone will reboot to make the change take effect.</p> <p>Web User Interface: Network->Basic->IPv4 Config->Static IP Address->Secondary DNS</p> <p>Phone User Interface: Menu->Settings->Advanced Settings (default password: admin) ->Network->WAN Port->IPv4->DHCP IPv4 Client->Static DNS (Enabled) ->IPv4 Sec.DNS</p>		

To configure static DNS address when DHCP is used via web user interface:

1. Click on **Network->Basic**.
2. In the **IPv4 Config** block, mark the **DHCP** radio box.
3. In the **Static DNS** block, mark the **On** radio box.

4. Enter the desired values in the **Primary DNS** and **Secondary DNS** fields.

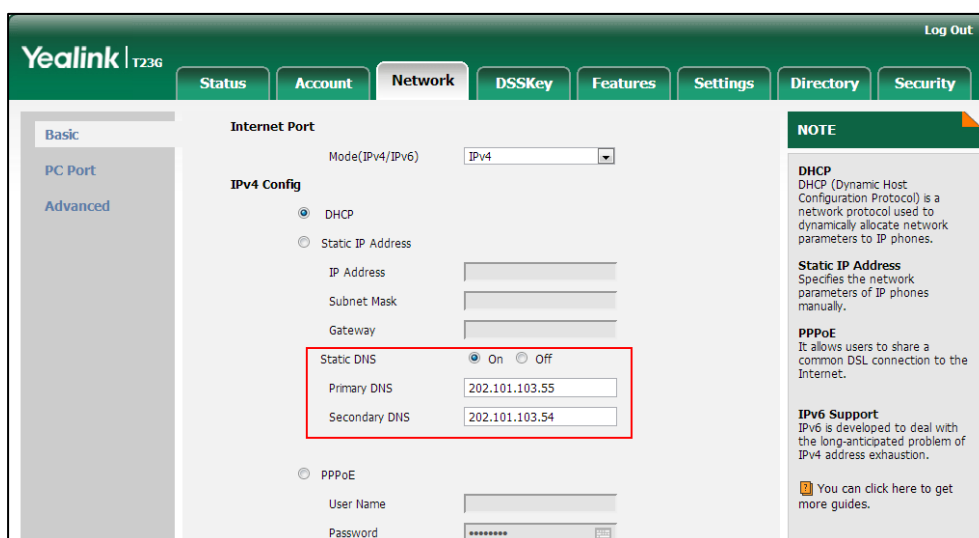

5. Click **Confirm** to accept the change.
A dialog box pops up to prompt that settings will take effect after a reboot.
6. Click **OK** to reboot the phone.

To configure static DNS when DHCP is used via phone user interface:

1. Press **Menu->Settings->Advanced Settings** (default password: admin)
->**Network->WAN Port->IPv4->DHCP IPv4 Client**.
2. Press **◀** or **▶**, or the **Switch** soft key to select **Enabled** from the **Static DNS** field.
3. Enter the desired values in the **IPv4 Pri.DNS** and **IPv4 Sec.DNS** fields respectively.
4. Press the **Save** soft key to accept the change.

The IP phone reboots automatically to make settings effective after a period of time.

DHCP Option

DHCP provides a framework for passing information to TCP/IP network devices. Network and other control information are carried in tagged data items that are stored in the options field of the DHCP message. The data items themselves are also called options.

DHCP can be initiated by simply connecting the IP phone with the network. IP phones broadcast DISCOVER messages to request the network information carried in DHCP options, and the DHCP server responds with specific values in corresponding options.

The following table lists common DHCP options supported by IP phones.

Parameter	DHCP Option	Description
Subnet Mask	1	Specify the client's subnet mask.
Time Offset	2	Specify the offset of the client's subnet in seconds from Coordinated Universal Time

Parameter	DHCP Option	Description
		(UTC).
Router	3	Specify a list of IP addresses for routers on the client's subnet.
Time Server	4	Specify a list of time servers available to the client.
Domain Name Server	6	Specify a list of domain name servers available to the client.
Log Server	7	Specify a list of MIT-LCS UDP servers available to the client.
Host Name	12	Specify the name of the client.
Domain Server	15	Specify the domain name that client should use when resolving hostnames via DNS.
Broadcast Address	28	Specify the broadcast address in use on the client's subnet.
Network Time Protocol Servers	42	Specify a list of NTP servers available to the client by IP address.
Vendor-Specific Information	43	Identify the vendor-specific information.
Vendor Class Identifier	60	Identify the vendor type.
TFTP Server Name	66	Identify a TFTP server when the 'sname' field in the DHCP header has been used for DHCP options.
Boot file Name	67	Identify a boot file when the 'file' field in the DHCP header has been used for DHCP options.

For more information on DHCP options, refer to <http://www.ietf.org/rfc/rfc2131.txt?number=2131> or <http://www.ietf.org/rfc/rfc2132.txt?number=2132>.

If you do not have the ability to configure the DHCP options for discovering the provisioning server on the DHCP server, an alternate method of automatically discovering the provisioning server address is required. Connecting to the secondary DHCP server that responds to DHCP INFORM queries with a requested provisioning server address is one possibility. For more information, refer to <http://www.ietf.org/rfc/rfc3925.txt?number=3925>.

DHCP Option 66 and Option 43

Yealink IP phones support obtaining the provisioning server address by detecting DHCP options during startup.

The phone will automatically detect the option 66 and option 43 for obtaining the provisioning server address. DHCP option 66 is used to identify the TFTP server. DHCP option 43 is a vendor-specific option, which is used to transfer the vendor-specific information.

To use DHCP option 66 or DHCP option 43, make sure the DHCP Active feature is enabled.

Procedure

DHCP active can be configured using the configuration files or locally.

Configuration File	<y0000000000xx>.cfg	Configure DHCP active. Parameters: auto_provision.dhcp_option.enable
Local	Web User Interface	Configure DHCP active. Navigate to: http://<phoneIPAddress>/servlet?p =settings-autop&q=load

Details of Configuration Parameters:

Parameters	Permitted Values	Default
auto_provision.dhcp_option.enable	0 or 1	1
<p>Description: Triggers the DHCP Option feature to on or off.</p> <p>0-Off 1-On</p> <p>If it is set to 1 (On), the IP phone will obtain the provisioning server address by detecting DHCP options.</p> <p>Web User Interface: Settings->Auto Provision->DHCP Active</p> <p>Phone User Interface: None</p>		

To configure the DHCP active feature via web user interface:

1. Click on **Settings->Auto Provision**.
2. Mark the **On** radio box in the **DHCP Active** field.

The screenshot shows the Yealink web user interface for the 'Auto Provision' settings. The 'DHCP Active' field is highlighted with a red box, and the 'On' radio button is selected. The page includes a sidebar with navigation options like Preference, Time & Date, Call Display, Upgrade, Auto Provision, Configuration, Dial Plan, Voice, Ring, Tones, Softkey Layout, TR069, Voice Monitoring, and STP. The main content area shows various settings for Auto Provision, including PNP Active, DHCP Active, Custom Option, DHCP Option Value, Server URL, User Name, Password, Attempt Expired Time, Common AES Key, MAC-Oriented AES Key, Zero Active, Wait Time, Power On, Repeatedly, Interval, and Weekly. A NOTE section on the right explains the Auto Provision process and provides a link to more guides.

3. Click **Confirm** to accept the change.

DHCP Option 42 and Option 2

Yealink IP phones support using the NTP server address offered by DHCP.

DHCP option 42 is used to specify a list of NTP servers available to the client by IP address. NTP servers should be listed in order of preference. DHCP option 2 is used to specify the offset of the client's subnet in seconds from Coordinated Universal Time (UTC).

To update time with the offset time offered by the DHCP server, make sure the DHCP Time feature is enabled at the web path **Settings->Time & Date->DHCP Time**. For more information on how to configure DHCP time feature, refer to [NTP Time Server](#) on page 132.

DHCP Option 12 Hostname on the IP Phone

This option specifies the host name of the client. The name may or may not be qualified with the local domain name (based on RFC 2132). See RFC 1035 for character restrictions.

Procedure

DHCP option 12 hostname can be configured using the configuration files or locally.

Configuration File	<y0000000000xx>.cfg	Configure the DHCP option 12 hostname. Parameters: network.dhcp_host_name
Local	Web User Interface	Configure the DHCP option 12 hostname. Navigate to: http://<phoneIPAddress>/servlet?p=features-general&q=load

Details of Configuration Parameters:

Parameters	Permitted Values	Default
network.dhcp_host_name	String within 99 characters	Refer to the following content
<p>Description: Configures the DHCP option 12 hostname on the IP phone.</p> <p>For SIP-T48G IP phones: The default value is SIP-T48G.</p> <p>For SIP-T46G IP phones: The default value is SIP-T46G.</p> <p>For SIP-T42G IP phones: The default value is SIP-T42G.</p> <p>For SIP-T41P IP phones: The default value is SIP-T41P.</p> <p>For SIP-T29G IP phones: The default value is SIP-T29G.</p> <p>For SIP-T27P IP phones: The default value is SIP-T27P.</p> <p>For SIP-T23P IP phones: The default value is SIP-T23P.</p> <p>For SIP-T23G IP phones: The default value is SIP-T23G.</p> <p>For SIP-T21(P) E2 IP phones: The default value is SIP-T21P_E2.</p>		

Parameters	Permitted Values	Default
<p>For SIP-T19(P) E2 IP phones:</p> <p>The default value is SIP-T19P_E2.</p> <p>Note: If you change this parameter, the IP phone will reboot to make the change take effect.</p> <p>Web User Interface:</p> <p>Features->General Information->DHCP Hostname</p> <p>Phone User Interface:</p> <p>None</p>		

To configure DHCP option 12 hostname on the IP phone via web user interface:

1. Click on **Feature->General Information**.
2. Enter the desired host name in the **DHCP Hostname** filed.

The screenshot shows the Yealink T23G web interface. The 'Features' tab is selected, and the 'General Information' sub-tab is active. The 'DHCP Hostname' field is highlighted with a red box and contains the text 'SIP-T23G'. Other fields include 'Call Waiting' (Enabled), 'Auto Redial' (Disabled), and 'Voice Mail Tone' (Enabled). A 'NOTE' sidebar on the right contains information about various features like Call Waiting, Auto Redial, Key As Send, Hotline, and Call Completion.

3. Click **Confirm** to accept the change.
A dialog box pops up to prompt that settings will take effect after a reboot.
4. Click **OK** to reboot the phone.

Configuring Network Parameters Manually

If DHCP is disabled or IP phones cannot obtain network parameters from the DHCP server, you need to configure them manually. The following parameters should be configured for IP phones to establish network connectivity:

- IP Address
- Subnet Mask

- Default Gateway
- Primary DNS
- Secondary DNS

Procedure

Network parameters can be configured manually using the configuration files or locally.

Configuration File	<MAC>.cfg	<p>Configure network parameters of the IP phone manually.</p> <p>Parameters:</p> <p>network.internet_port.type network.ip_address_mode network.internet_port.ip network.internet_port.mask network.internet_port.gateway network.primary_dns network.secondary_dns</p>
Local	Web User Interface	<p>Configure network parameters of the IP phone manually.</p> <p>Navigate to:</p> <p>http://<phoneIPAddress>/servlet?p=network&q=load</p>
	Phone User Interface	<p>Configure network parameters of the IP phone manually.</p>

Details of Configuration Parameters:

Parameters	Permitted Values	Default
network.internet_port.type	0, 1 or 2	0
<p>Description:</p> <p>Configures the Internet (WAN) port type for IPv4.</p> <p>0-DHCP</p> <p>1-PPPoE (not applicable to SIP-T42G/T41P IP phones)</p> <p>2-Static IP Address</p> <p>Note: It works only if the value of the parameter “network.ip_address_mode” is set to 0 (IPv4) or 2 (IPv4 & IPv6). If you change this parameter, the IP phone will reboot to make the change take effect.</p> <p>Web User Interface:</p>		

Parameters	Permitted Values	Default
Network->Basic->IPv4 Config Phone User Interface: Menu->Settings->Advanced Settings (default password: admin) ->Network->WAN Port->IPv4		
network.ip_address_mode	0, 1 or 2	0
Description: Configures the IP address mode. 0 -IPv4 1 -IPv6 2 -IPv4 & IPv6 Note: If you change this parameter, the IP phone will reboot to make the change take effect. Web User Interface: Network->Basic->Internet Port-> Mode(IPv4/IPv6) Phone User Interface: Menu->Settings->Advanced Settings (default password: admin) ->Network->WAN Port->IP Mode		
network.internet_port.ip	IPv4 Address	Blank
Description: Configures the IPv4 address. Example: network.internet_port.ip = 192.168.1.20 Note: It works only if the value of the parameter "network.ip_address_mode" is set to 0 (IPv4) or 2 (IPv4 & IPv6), and "network.internet_port.type" is set to 2 (Static IP Address). If you change this parameter, the IP phone will reboot to make the change take effect. Web User Interface: Network->Basic->IPv4 Config->Static IP Address->IP Address Phone User Interface: Menu->Settings->Advanced Settings (default password: admin) ->Network->WAN Port->IPv4->Static IPv4 Client->IPv4		
network.internet_port.mask	Subnet Mask	Blank

Parameters	Permitted Values	Default
<p>Description: Configures the IPv4 subnet mask.</p> <p>Example: network.internet_port.mask = 255.255.255.0</p> <p>Note: It works only if the value of the parameter "network.ip_address_mode" is set to 0 (IPv4) or 2 (IPv4 & IPv6), and "network.internet_port.type" is set to 2 (Static IP Address). If you change this parameter, the IP phone will reboot to make the change take effect.</p> <p>Web User Interface: Network->Basic->IPv4 Config->Static IP Address->Subnet Mask</p> <p>Phone User Interface: Menu->Settings->Advanced Settings (default password: admin) ->Network->WAN Port->IPv4->Static IPv4 Client->Subnet Mask</p>		
network.internet_port.gateway	IPv4 Address	Blank
<p>Description: Configures the IPv4 default gateway.</p> <p>Example: network.internet_port.gateway = 192.168.1.254</p> <p>Note: It works only if the value of the parameter "network.ip_address_mode" is set to 0 (IPv4) or 2 (IPv4 & IPv6), and "network.internet_port.type" is set to 2 (Static IP Address). If you change this parameter, the IP phone will reboot to make the change take effect.</p> <p>Web User Interface: Network->Basic->IPv4 Config->Static IP Address->Gateway</p> <p>Phone User Interface: Menu->Settings->Advanced Settings (default password: admin) ->Network->WAN Port->IPv4->Static IPv4 Client->Default Gateway</p>		
network.primary_dns	IPv4 Address	Blank

Parameters	Permitted Values	Default
<p>Description: Configures the primary IPv4 DNS server.</p> <p>Example: network.primary_dns = 202.101.103.55</p> <p>Note: It works only if the value of the parameter "network.ip_address_mode" is set to 0 (IPv4) or 2 (IPv4 & IPv6), and "network.internet_port.type" is set to 2 (Static IP Address). If you change this parameter, the IP phone will reboot to make the change take effect.</p> <p>Web User Interface: Network->Basic->IPv4 Config->Static IP Address->Primary DNS</p> <p>Phone User Interface: Menu->Settings->Advanced Settings (default password: admin) ->Network->WAN Port->IPv4->Static IPv4 Client->IPv4 Pri.DNS</p>		
network.secondary_dns	IPv4 Address	Blank
<p>Description: Configures the secondary IPv4 DNS server.</p> <p>Example: network.secondary_dns = 202.101.103.54</p> <p>Note: It works only if the value of the parameter "network.ip_address_mode" is set to 0 (IPv4) or 2 (IPv4 & IPv6), and "network.internet_port.type" is set to 2 (Static IP Address). If you change this parameter, the IP phone will reboot to make the change take effect.</p> <p>Web User Interface: Network->Basic->IPv4 Config->Static IP Address->Secondary DNS</p> <p>Phone User Interface: Menu->Settings->Advanced Settings (default password: admin) ->Network->WAN Port->IPv4->Static IPv4 Client->IPv4 Sec.DNS</p>		

To configure the IP address mode via web user interface:

1. Click on **Network->Basic**.

3. Select desired value from the pull-down list of **Mode(IPv4/IPv6)**.

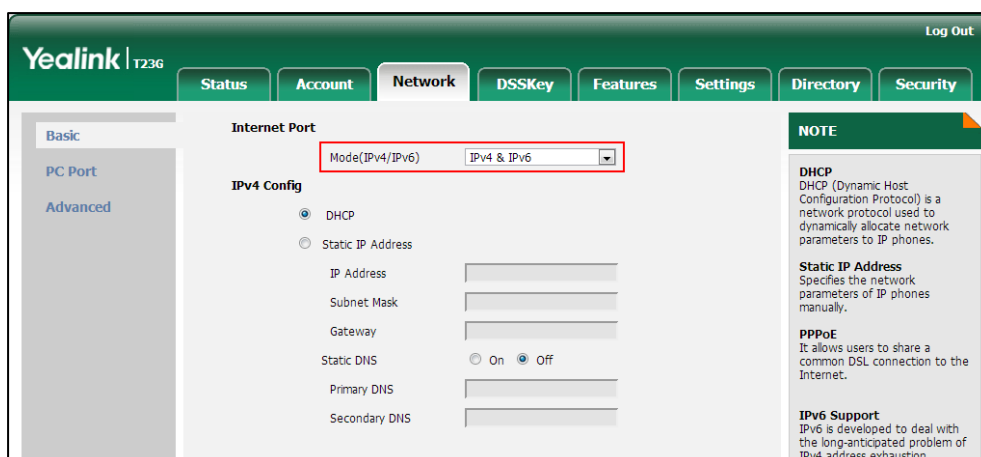

4. Click **Confirm** to accept the change.
A dialog box pops up to prompt that settings will take effect after a reboot.
5. Click **OK** to reboot the phone.

To configure a static IPv4 address via web user interface:

1. Click on **Network->Basic**.
2. In the **IPv4 Config** block, mark the **Static IP Address** radio box.
3. Enter the desired values in the **IP Address, Subnet Mask, Gateway, Primary DNS** and **Secondary DNS** fields.

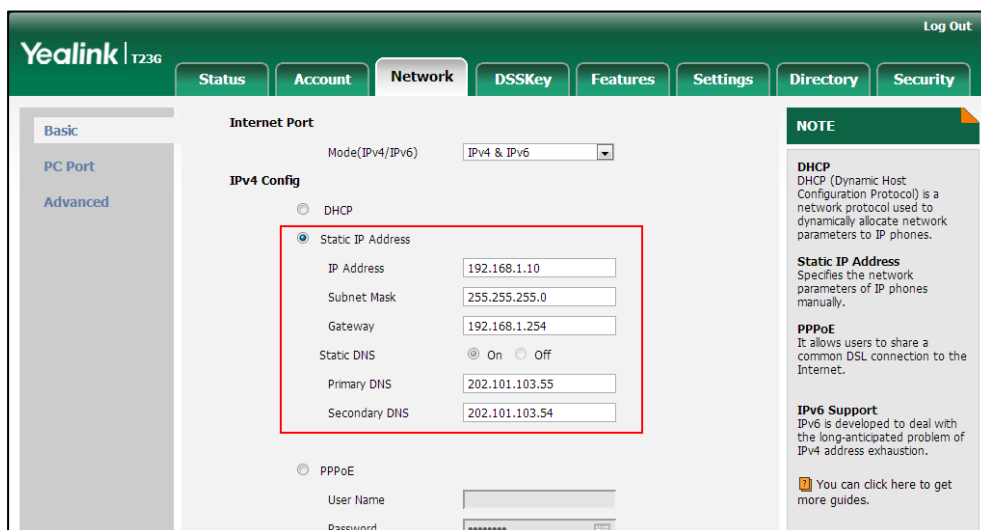

4. Click **Confirm** to accept the change.
A dialog box pops up to prompt that settings will take effect after a reboot.
5. Click **OK** to reboot the phone.

To configure the IP address mode via phone user interface:

1. Press **Menu->Settings->Advanced Settings** (default password: admin)
->**Network->WAN Port**.
2. Press ◀ or ▶ to select **IPv4** or **IPv4 & IPv6** from the **IP Mode** field.
3. Press the **Save** soft key to accept the change.

The IP phone reboots automatically to make settings effective after a period of time.

To configure a static IPv4 address via phone user interface:

1. Press **Menu->Settings->Advanced Settings** (default password: admin)
->**Network->WAN Port->IPv4->Static IPv4 Client**.
2. Enter the desired values in the **IPv4, Subnet Mask, Default Gateway** and **IPv4 Pri.DNS** and **IPv4 Sec.DNS** fields respectively.
3. Press the **Save** soft key to accept the change.

The IP phone reboots automatically to make settings effective after a period of time.

PPPoE

PPPoE (Point-to-Point Protocol over Ethernet) is a network protocol used by Internet Service Providers (ISPs) to provide Digital Subscriber Line (DSL) high speed Internet services. PPPoE allows an office or building-full of users to share a common DSL connection to the Internet. PPPoE connection is supported by the IP phone Internet port. Contact your ISP for the PPPoE user name and password. PPPoE is not applicable to SIP-T42G and SIP-T41P IP phones.

Procedure

PPPoE can be configured using the configuration files or locally.

Configuration File	<MAC>.cfg	Configure PPPoE on the IP phone. Parameters: network.internet_port.type
	<y0000000000xx>.cfg	Configure the user name and password for PPPoE on the IP phone. Parameters: network.pppoe.user network.pppoe.password
Local	Web User Interface	Configure PPPoE on the IP phone. Configure the user name and password for PPPoE on the IP phone.

		<p>Navigate to:</p> <p>http://<phoneIPAddress>/servlet ?p=network&q=load</p>
	Phone User Interface	<p>Configure PPPoE on the IP phone.</p> <p>Configure the user name and password for PPPoE on the IP phone.</p>

Details of Configuration Parameters:

Parameters	Permitted Values	Default
network.internet_port.type	0, 1 or 2	0
<p>Description:</p> <p>Configures the Internet (WAN) port type for IPv4.</p> <p>0-DHCP</p> <p>1-PPPoE (not applicable to SIP-T42G/T41P IP phones)</p> <p>2-Static IP Address</p> <p>Note: It works only if the value of the parameter "network.ip_address_mode" is set to 0 (IPv4) or 2 (IPv4 & IPv6). If you change this parameter, the IP phone will reboot to make the change take effect.</p> <p>Web User Interface:</p> <p>Network->Basic->IPv4 Config</p> <p>Phone User Interface:</p> <p>Menu->Settings->Advanced Settings (default password: admin) ->Network->WAN Port->IPv4</p>		
network.pppoe.user	String within 32 characters	Blank
<p>Description:</p> <p>Configures the user name for PPPoE connection.</p> <p>Example:</p> <p>network.pppoe.user = Xmyl0592123</p> <p>Note: It works only if the value of the parameter "network.ip_address_mode" is set to 0 (IPv4) or 2 (IPv4 & IPv6), and "network.internet_port.type" is set to 1 (PPPoE). If you change this parameter, the IP phone will reboot to make the change take effect.</p> <p>Web User Interface:</p> <p>Network->Basic->IPv4 Config->PPPoE->User Name</p> <p>Phone User Interface:</p>		

Parameters	Permitted Values	Default
Menu->Settings->Advanced Settings (default password: admin) ->Network->WAN Port->IPv4->PPPoE IPv4 Client->PPPoE User		
network.pppoe.password	String within 99 characters	Blank
<p>Description: Configures the password for PPPoE connection.</p> <p>Example: network.pppoe.password = yealink123</p> <p>Note: It works only if the value of the parameter "network.ip_address_mode" is set to 0 (IPv4) or 2 (IPv4 & IPv6), and "network.internet_port.type" is set to 1 (PPPoE). If you change this parameter, the IP phone will reboot to make the change take effect.</p> <p>Web User Interface: Network->Basic->IPv4 Config->PPPoE->Password</p> <p>Phone User Interface: Menu->Settings->Advanced Settings (default password: admin) ->Network->WAN Port->IPv4->PPPoE IPv4 Client->PPPoE PWD</p>		

To configure PPPoE via web user interface:

1. Click on **Network->Basic**.
2. In the **IPv4 Config** block, mark the **PPPoE** radio box.
3. Enter the user name and password in corresponding fields.

The screenshot shows the Yealink T236 web user interface. The 'Network' tab is selected, and the 'IPv4 Config' section is active. The 'PPPoE' radio button is selected, and the 'User Name' field contains 'Xmyl0592123' and the 'Password' field is masked with asterisks. A red box highlights the 'PPPoE' radio button and the input fields. A 'NOTE' section on the right provides information about DHCP, Static IP Address, PPPoE, and IPv6 Support.

4. Click **Confirm** to accept the change.
A dialog box pops up to prompt that settings will take effect after a reboot.
5. Click **OK** to reboot the phone.

To configure PPPoE via phone user interface:

1. Press **Menu->Settings->Advanced Settings** (default password: admin)
->**Network->WAN Port->IPv4->PPPoE IPv4 Client**.
2. Enter the user name and password in corresponding fields.
3. Press the **Save** soft key to accept the change.

The IP phone reboots automatically to make settings effective after a period of time.

Configuring Transmission Methods of the Internet Port and PC

Port

Two Ethernet ports on the back of the IP phone: Internet port and PC port. Three optional methods of transmission configuration for IP phone Internet or PC Ethernet ports:

- Auto-negotiate
- Half-duplex
- Full-duplex

Auto-negotiate is configured for both Internet and PC ports on the IP phone by default.

Auto-negotiate

Auto-negotiate means that two connected devices choose common transmission parameters (e.g., speed and duplex mode) to transmit voice or data over Ethernet. This process entails devices first sharing transmission capabilities and then selecting the highest performance transmission mode supported by both. You can configure the Internet port and PC port on the IP phone to automatically negotiate during the transmission.

Half-duplex

Half-duplex transmission refers to transmitting voice or data in both directions, but in one direction at a time; this means one device can send data on the line, but not receive data simultaneously. You can configure the half-duplex transmission on both Internet port and PC port for the IP phone to transmit in 10Mbps or 100Mbps.

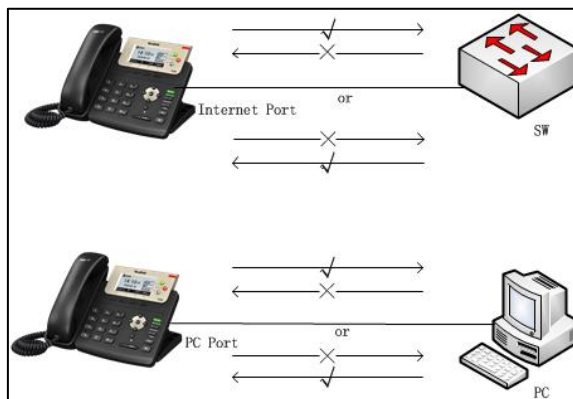

Full-duplex

Full-duplex transmission refers to transmitting voice or data in both directions at the same time; this means one device can send data on the line while receiving data. You can configure the full-duplex transmission on both Internet port and PC port for the IP phone to transmit in 10Mbps, 100Mbps or 1000Mbps (1000Mbps is only applicable to SIP-T48G/T46G/T42G/T29G/T23G IP phones).

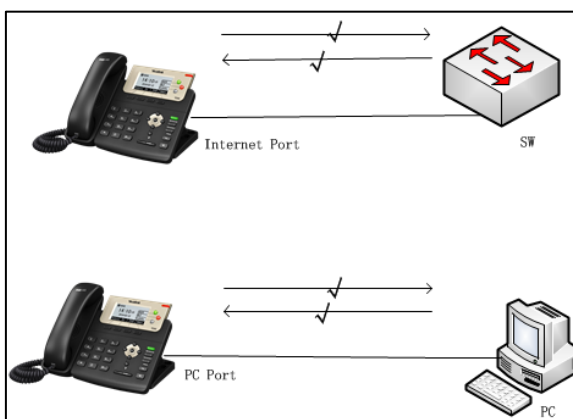

Procedure

The transmission methods of Ethernet ports can be configured using the configuration files or locally.

Configuration File	<y0000000000xx>.cfg	Configure the transmission methods of the Internet (WAN) port. Parameters: network.internet_port.speed_duplex
---------------------------	---------------------	--

		network.pc_port.speed_duplex
Local	Web User Interface	<p>Configure the transmission methods of the Internet (WAN) port.</p> <p>Navigate to:</p> <p>http://<phoneIPAddress>/servlet?p=network-adv&q=load</p>

Details of Configuration Parameters:

Parameters	Permitted Values	Default
network.internet_port.speed_duplex	0, 1, 2, 3, 4 or 5	0
<p>Description:</p> <p>Configures the transmission method of the Internet (WAN) port.</p> <p>0-Auto Negotiate</p> <p>1-Full Duplex 10Mbps</p> <p>2-Full Duplex 100Mbps</p> <p>3-Half Duplex 10Mbps</p> <p>4-Half Duplex 100Mbps</p> <p>5-FullDuplex 1000Mbps (only applicable to SIP-T48G/T46G/T42G IP phones)</p> <p>Note: For SIP-T29G and SIP-T23G IP phones, you are not allowed to manually set the transmission speed to 1000Mbps. But you can set it to auto negotiate to transmit in 1000Mbps. We recommend that you do not change this parameter. If you change this parameter, the IP phone will reboot to make the change take effect.</p> <p>Web User Interface:</p> <p>Network->Advanced->Port Link->WAN Port Link</p> <p>Phone User Interface:</p> <p>None</p>		
network.pc_port.speed_duplex	0, 1, 2, 3, 4 or 5	0
<p>Description:</p> <p>Configures the transmission method of the Internet (WAN) port.</p> <p>0-Auto Negotiate</p> <p>1-Full Duplex 10Mbps</p> <p>2-Full Duplex 100Mbps</p> <p>3-Half Duplex 10Mbps</p> <p>4-Half Duplex 100Mbps</p>		

Parameters	Permitted Values	Default
<p>5-Full Duplex 1000Mbps (only applicable to SIP-T48G/T46G/T42G IP phones)</p> <p>Note: For SIP-T29G and SIP-T23G IP phones, you are not allowed to manually set the transmission speed to 1000Mbps. But you can set it to auto negotiate to transmit in 1000Mbps. We recommend that you do not change this parameter. If you change this parameter, the IP phone will reboot to make the change take effect.</p> <p>Web User Interface: Network->Advanced->Port Link->PC Port Link</p> <p>Phone User Interface: None</p>		

To configure the transmission methods of Ethernet ports via web user interface:

1. Click on **Network->Advanced**.
2. Select the desired value from the pull-down list of **WAN Port Link**.
3. Select the desired value from the pull-down list of **PC Port Link**.

The screenshot shows the Yealink T236 web user interface. The 'Network' tab is selected, and the 'Advanced' sub-tab is active. The 'Port Link' section is highlighted with a red box, showing the following configuration:

Parameter	Value
WAN Port Link	Auto Negotiate
PC Port Link	Auto Negotiate

Other visible configuration items include:

- LLDP:** Active, Enabled, Packet Interval (1~3600s): 60
- CDP:** Active, Disabled, Packet Interval (1~3600s): 60
- VLAN:** WAN Port: Active, Disabled, VID (1-4094): 1
- Voice QoS:** Voice QoS (0~63): 46, SIP QoS (0~63): 26
- Local RTP Port:** Max RTP Port (1~65535): 12780, Min RTP Port (1~65535): 11780
- VPN:** Active, Enabled, Upload VPN Config: [Browse...], [Upload]

The 'NOTE' section on the right contains information about VLAN, NAT Traversal, Quality of Service (QoS), Web Server Type, and 802.1X Authentication.

4. Click **Confirm** to accept the change.

Configuring PC Port Mode

The PC port on the back of the IP phone is used to connect a PC. You can enable or disable the PC (LAN) port on the IP phones via web user interface or using configuration files.

Procedure

PC port mode can be configured using the configuration files or locally.

Configuration File	<y0000000000xx>.cfg	Configure the PC (LAN) port. Parameter: network.pc_port.enable
Local	Web User Interface	Configure the PC (LAN) port. Navigate to: http://<phoneIPAddress>/servlet ?p=network-pcport&q=load

Details of Configuration Parameters:

Parameters	Permitted Values	Default
network.pc_port.enable	0 or 1	1
<p>Description: Enables or disables the PC (LAN) port. 0-Disabled 1-Auto Negotiate</p> <p>Note: If you change this parameter, the IP phone will reboot to make the change take effect.</p> <p>Web User Interface: Network->PC Port->PC Port Active</p> <p>Phone User Interface: None</p>		

To enable the PC port via web user interface:

1. Click on **Network->PC Port**.

2. Select **Auto Negotiate** from the pull-down list of **PC Port Active**.

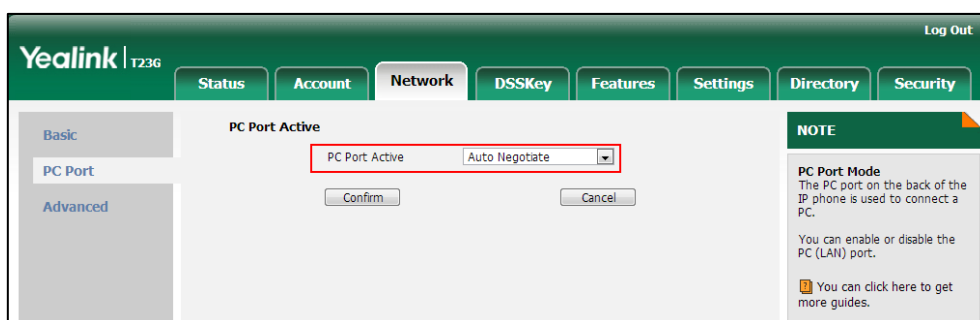

3. Click **Confirm** to accept the change.
A dialog box pops up to prompt that settings will take effect after a reboot.
4. Click **OK** to reboot the phone.

To disable the PC port via web user interface:

1. Click on **Network->PC Port**.
2. Select **Disabled** from the pull-down list of **PC Port Active**.

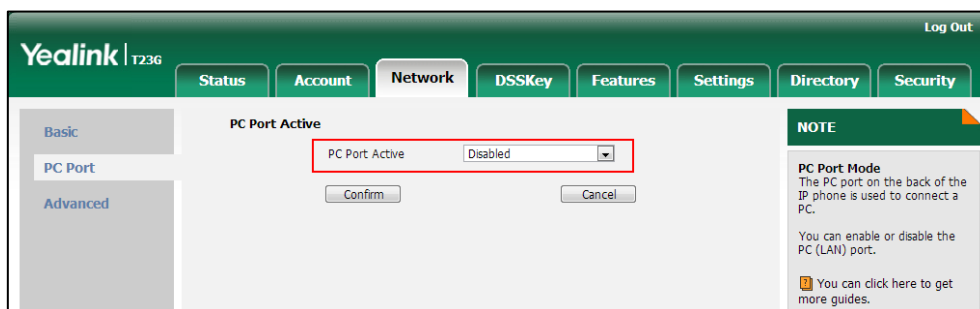

3. Click **Confirm** to accept the change.
A dialog box pops up to prompt that settings will take effect after a reboot.
4. Click **OK** to reboot the phone.

Upgrading Firmware

This section provides information on upgrading the IP phone firmware. Two methods of firmware upgrade:

- Manually, from the local system for a single phone.
- Automatically, from the provisioning server for a mass of phones.

The following table lists the associated and latest firmware name for each IP phone model (X is replaced by the actual firmware version).

IP Phone Model	Associated Firmware Name	Firmware Name Example
SIP-T48G	35.x.x.x.rom	35.80.0.60.rom

IP Phone Model	Associated Firmware Name	Firmware Name Example
SIP-T46G	28.x.x.x.rom	28.80.0.60.rom
SIP-T42G	29.x.x.x.rom	29.80.0.60.rom
SIP-T41P	36.x.x.x.rom	36.80.0.60.rom
SIP-T29G	46.x.x.x.rom	46.80.0.60.rom
SIP-T27P	45.x.x.x.rom	45.80.0.60.rom
SIP-T23P/G	44.x.x.x.rom	44.80.0.60.rom
SIP-T21(P) E2	52.x.x.x.rom	52.80.0.60.rom
SIP-T19(P) E2	53.x.x.x.rom	53.80.0.60.rom

Note You can download the latest firmware online:
<http://support.yealink.com/documentFront/forwardToDocumentFrontDisplayPage>.
 Do not unplug the network and power cables when the IP phone is upgrading firmware.

Upgrading Firmware via Web User Interface

To manually upgrade firmware via web user interface, you need to store firmware to your local system in advance.

To upgrade firmware manually via web user interface:

1. Click on **Settings->Upgrade**.
2. Click **Browse** to locate the required firmware from your local system.
3. Click **Upgrade**.

A dialog box pops up to prompt “Firmware of the SIP Phone will be updated. It will take 5 minutes to complete. Please don't power off!”.

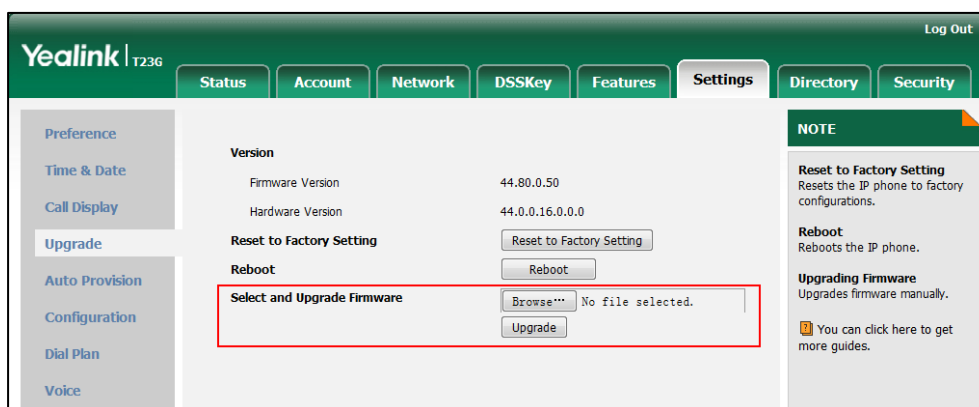

4. Click **OK** to confirm the upgrade.

Note Do not close and refresh the browser when the IP phone is upgrading firmware via web user interface.

Upgrading Firmware from the Provisioning Server

IP phones support using FTP, TFTP, HTTP and HTTPS protocols to download configuration files and firmware from the provisioning server, and then upgrade firmware automatically.

IP phones can download firmware stored on the provisioning server in one of two ways:

- Check for configuration files and then download firmware during startup.
- Automatically check for configuration files and then download firmware at a fixed interval or specific time.

Method of checking for configuration files is configurable.

Procedure

Configuration changes can be performed using the configuration files or locally.

Configuration File	<y0000000000xx>.cfg	<p>Configure the way for the IP phone to check for configuration files.</p> <p>Parameters:</p> <p>auto_provision.power_on auto_provision.repeat.enable auto_provision.repeat.minutes auto_provision.weekly.enable auto_provision.weekly.begin_time auto_provision.weekly.end_time auto_provision.weekly.dayofweek</p> <p>Specify the access URL of firmware.</p> <p>Parameter:</p> <p>firmware.url</p>
Local	Web User Interface	<p>Configure the way for the IP phone to check for configuration files.</p> <p>Navigate to:</p> <p>http://<phoneIPAddress>/servlet?p=settings-autop&q=load</p>

Details of Configuration Parameters:

Parameters	Permitted Values	Default
auto_provision.power_on	0 or 1	1

Parameters	Permitted Values	Default
<p>Description: Triggers the power on feature to on or off. 0-Off 1-On If it is set to 1 (On), the IP phone will perform an auto provisioning process when powered on.</p> <p>Web User Interface: Settings->Auto Provision->Power On</p> <p>Phone User Interface: None</p>		
auto_provision.repeat.enable	0 or 1	0
<p>Description: Triggers the repeatedly feature to on or off. 0-Off 1-On If it is set to 1 (On), the IP phone will perform an auto provisioning process repeatedly.</p> <p>Web User Interface: Settings->Auto Provision->Repeatedly</p> <p>Phone User Interface: None</p>		
auto_provision.repeat.minutes	Integer from 1 to 43200	1440
<p>Description: Configures the interval (in minutes) for the IP phone to perform an auto provisioning process repeatedly. Note: It works only if the value of the parameter "auto_provision.repeat.enable" is set to 1 (On).</p> <p>Web User Interface: Settings->Auto Provision->Interval(Minutes)</p> <p>Phone User Interface: None</p>		
auto_provision.weekly.enable	0 or 1	0

Parameters	Permitted Values	Default
<p>Description: Triggers the weekly feature to on or off.</p> <p>0-Off 1-On</p> <p>If it is set to 1 (On), the IP phone will perform an auto provisioning process weekly.</p> <p>Web User Interface: Settings->Auto Provision->Weekly</p> <p>Phone User Interface: None</p>		
auto_provision.weekly.begin_time	Time from 00:00 to 23:59	00:00
<p>Description: Configures the begin time of the day for the IP phone to perform an auto provisioning process weekly.</p> <p>Note: It works only if the value of the parameter "auto_provision.weekly.enable" is set to 1 (On).</p> <p>Web User Interface: Settings->Auto Provision->Time</p> <p>Phone User Interface: None</p>		
auto_provision.weekly.end_time	Time from 00:00 to 23:59	00:00
<p>Description: Configures the end time of the day for the IP phone to perform an auto provisioning process weekly.</p> <p>Note: It works only if the value of the parameter "auto_provision.weekly.enable" is set to 1 (On).</p> <p>Web User Interface: Settings->Auto Provision->Time</p> <p>Phone User Interface: None</p>		
auto_provision.weekly.dayofweek	0, 1, 2, 3, 4, 5, 6 or a combination of these digits	0123456

Parameters	Permitted Values	Default
<p>Description: Configures the days of the week for the IP phone to perform an auto provisioning process weekly.</p> <p>0-Sunday 1-Monday 2-Tuesday 3-Wednesday 4-Thursday 5-Friday 6-Saturday</p> <p>Example: auto_provision.weekly.dayofweek = 01 It means the IP phone will perform an auto provisioning process every Sunday and Monday.</p> <p>Note: It works only if the value of the parameter "auto_provision.weekly.enable" is set to 1 (On).</p> <p>Web User Interface: Settings->Auto Provision->Day of Week</p> <p>Phone User Interface: None</p>		
firmware.url	URL within 511 characters	Blank
<p>Description: Configures the access URL of the firmware file.</p> <p>Example: firmware.url = http://192.168.1.20/44.80.0.60.rom</p> <p>Note: If you change this parameter, the IP phone will reboot to make the change take effect.</p> <p>Web User Interface: Settings->Upgrade->Select and Upgrade Firmware</p> <p>Phone User Interface: None</p>		

To configure the way for the IP phone to check for configuration files via web user interface:

1. Click on **Settings->Auto Provision**.

2. Make the desired change.

The screenshot shows the Yealink T236 web interface with the 'Settings' tab selected. The 'Auto Provision' section is active, displaying various configuration options. The 'Power On' option is set to 'On'. A 'NOTE' box on the right explains that the IP phone will request configuration files from a provisioning server during the auto provisioning process. At the bottom of the settings area, there are 'Confirm' and 'Cancel' buttons.

Setting	Value
PNP Active	<input checked="" type="radio"/> On <input type="radio"/> Off
DHCP Active	<input checked="" type="radio"/> On <input type="radio"/> Off
Custom Option(128~254)	
DHCP Option Value	yealink
Server URL	
User Name	
Password	*****
Attempt Expired Time(s)	5
Common AES Key	*****
MAC-Oriented AES Key	*****
Zero Active	Disabled
Wait Time(1~100s)	5
Power On	<input checked="" type="radio"/> On <input type="radio"/> Off
Repeatedly	<input type="radio"/> On <input checked="" type="radio"/> Off
Interval(Minutes)	1440
Weekly	<input type="radio"/> On <input checked="" type="radio"/> Off
Time	00 : 00 -- 00 : 00
Day of Week	<input checked="" type="checkbox"/> Sunday <input checked="" type="checkbox"/> Monday <input checked="" type="checkbox"/> Tuesday <input checked="" type="checkbox"/> Wednesday <input checked="" type="checkbox"/> Thursday <input checked="" type="checkbox"/> Friday <input checked="" type="checkbox"/> Saturday

NOTE
Auto Provision
The IP phone can interoperate with provisioning server using auto provisioning for deploying the IP phones.
When the IP phone triggers to perform auto provisioning, it will request to download the configuration files from the provisioning server. During the auto provisioning process, the IP phone will download and update configuration files to the phone flash.
You can click here to get more guides.

3. Click **Confirm** to accept the change.

When the "Power On" is set to **On**, the IP phone will check configuration files stored on the provisioning server during startup and then will download firmware from the server.

Configuring Basic Features

This chapter provides information for making configuration changes for the following basic features:

- [Power Indicator LED](#)
- [Notification Popups](#)
- [Contrast](#)
- [Wallpaper](#)
- [Backlight](#)
- [Bluetooth](#)
- [Enable Page Tips](#)
- [Label Length](#)
- [Account Registration](#)
- [Call Display](#)
- [Display Method on Dialing](#)
- [Web Server Type](#)
- [Time and Date](#)
- [Language](#)
- [Input Method](#)
- [Logo Customization](#)
- [Softkey Layout](#)
- [Key As Send](#)
- [Dial Plan](#)
- [Hotline](#)
- [Off Hook Hot Line Dialing](#)
- [Directory](#)
- [Search Source in Dialing](#)
- [Save Call Log](#)
- [Call List Show Number](#)
- [Missed Call Log](#)
- [Local Directory](#)
- [Live Dialpad](#)
- [Call Waiting](#)

- Redial Tone
- Ringer Device for Headset
- Auto Redial
- Auto Answer
- IP Direct Auto Answer
- Allow IP Call
- Accept SIP Trust Server Only
- Call Completion
- Anonymous Call
- Anonymous Call Rejection
- Do Not Disturb
- Busy Tone Delay
- Return Code When Refuse
- Early Media
- 180 Ring Workaround
- Use Outbound Proxy in Dialog
- SIP Session Timer
- Session Timer
- Call Hold
- Call Forward
- Call Transfer
- Network Conference
- Feature Key Synchronization
- Transfer on Conference Hang Up
- Transfer Mode via Dsskey
- Allow Trans Exist Call
- Directed Call Pickup
- Group Call Pickup
- Dialog Info Call Pickup
- Recent Call In Dialing
- ReCall
- Call Number Filter
- Call Park
- Calling Line Identification Presentation

- [Connected Line Identification Presentation](#)
- [DTMF](#)
- [Allow Mute](#)
- [Intercom](#)
- [Call Timeout](#)
- [Ringing Timeout](#)
- [Send user=phone](#)
- [SIP Send MAC](#)
- [SIP Send Line](#)
- [Reserve # in User Name](#)
- [Password Dial](#)
- [Unregister When Reboot](#)
- [100 Reliable Retransmission](#)
- [Reboot in Talking](#)

Power Indicator LED

Power indicator LED indicates power status and phone status. There are six configuration options for power indicator LED:

Common Power Light On

Common Power Light On allows the power indicator LED to be turned on.

Ringing Power Light Flash

Ringing Power Light Flash allows the power indicator LED to flash when the IP phone receives an incoming call.

Voice/Text Mail Power Light Flash

Voice/Text Mail Power Light Flash allows the power indicator LED to flash when the IP phone receives a voice mail or a text message.

Mute Power Light Flash

Mute Power Light Flash allows the power indicator LED to flash when a call is mute.

Hold/Held Power Light Flash

Hold/Held Power Light Flash allows the power indicator LED to flash when a call is placed on hold or is held.

Talk/Dial Power Light On

Talk/Dial Power Light On allows the power indicator LED to be turned on when the IP

phone is busy.

Procedure

Power indicator LED can be configured using the configuration files or locally.

Configuration File	<y0000000000xx>.cfg	Configure the power indicator LED. Parameters: phone_setting.common_power_led_enable phone_setting.ring_power_led_flash_enable phone_setting.mail_power_led_flash_enable phone_setting.mute_power_led_flash_enable phone_setting.hold_and_held_power_led_flash_enable phone_setting.talk_and_dial_power_led_enable
Local	Web User Interface	Configure the power indicator LED. Navigate to: http://<phoneIPAddress>/servlet?p=features-poweredled&q=load

Details of Configuration Parameters:

Parameters	Permitted Values	Default
phone_setting.common_power_led_enable	0 or 1	0
<p>Description: Enables or disables the power indicator LED to be turned on. 0-Disabled (power indicator LED is off) 1-Enabled (power indicator LED is solid red)</p> <p>Web User Interface: Features->Power LED->Common Power Light On</p> <p>Phone User Interface: None</p>		
phone_setting.ring_power_led_flash_enable	0 or 1	1

Parameters	Permitted Values	Default
<p>Description: Enables or disables the power indicator LED to flash when the IP phone receives an incoming call.</p> <p>0-Disabled (power indicator LED does not flash) 1-Enabled (power indicator LED fast flashes (300ms) red)</p> <p>Web User Interface: Features->Power LED->Ringing Power Light Flash</p> <p>Phone User Interface: None</p>		
<p>phone_setting.mail_power_led_flash_enable</p>	<p>0 or 1</p>	<p>1</p>
<p>Description: Enables or disables the power indicator LED to flash when the IP phone receives a voice mail or a text message.</p> <p>0-Disabled (power indicator LED does not flash) 1-Enabled (power indicator LED slow flashes (1000ms) red)</p> <p>Web User Interface: Features->Power LED->Voice/Text Mail Power Light Flash</p> <p>Phone User Interface: None</p>		
<p>phone_setting.mute_power_led_flash_enable</p>	<p>0 or 1</p>	<p>0</p>
<p>Description: Enables or disables the power indicator LED to flash when a call is mute.</p> <p>0-Disabled (power indicator LED does not flash) 1-Enabled (power indicator LED fast flashes (300ms) red)</p> <p>Web User Interface: Features->Power LED->Mute Power Light Flash</p> <p>Phone User Interface: None</p>		
<p>phone_setting.hold_and_held_power_led_flash_enable</p>	<p>0 or 1</p>	<p>0</p>
<p>Description: Enables or disables the power indicator LED to flash when a call is placed on hold or is held.</p>		

Parameters	Permitted Values	Default
<p>0-Disabled (power indicator LED does not flash) 1-Enabled (power indicator LED fast flashes (500ms) red)</p> <p>Web User Interface: Features->Power LED->Hold/Held Power Light Flash</p> <p>Phone User Interface: None</p>		
phone_setting.talk_and_dial_power_led_enable	0 or 1	0
<p>Description: Enables or disables the power indicator LED to be turned on when the IP phone is busy.</p> <p>0-Disabled (power indicator LED is off) 1-Enabled (power indicator LED is solid red)</p> <p>Web User Interface: Features->Power LED->Talk/Dial Power Light On</p> <p>Phone User Interface: None</p>		

To configure the power Indicator LED via web user interface:

1. Click on **Features->Power LED**.
2. Select the desired value from the pull-down list of **Common Power Light On**.
3. Select the desired value from the pull-down list of **Ringing Power Light Flash**.
4. Select the desired value from the pull-down list of **Voice/Text Mail Power Light Flash**.
5. Select the desired value from the pull-down list of **Mute Power Light Flash**.
6. Select the desired value from the pull-down list of **Hold/Held Power Light Flash**.

7. Select the desired value from the pull-down list of **Talk/Dial Power Light On**.

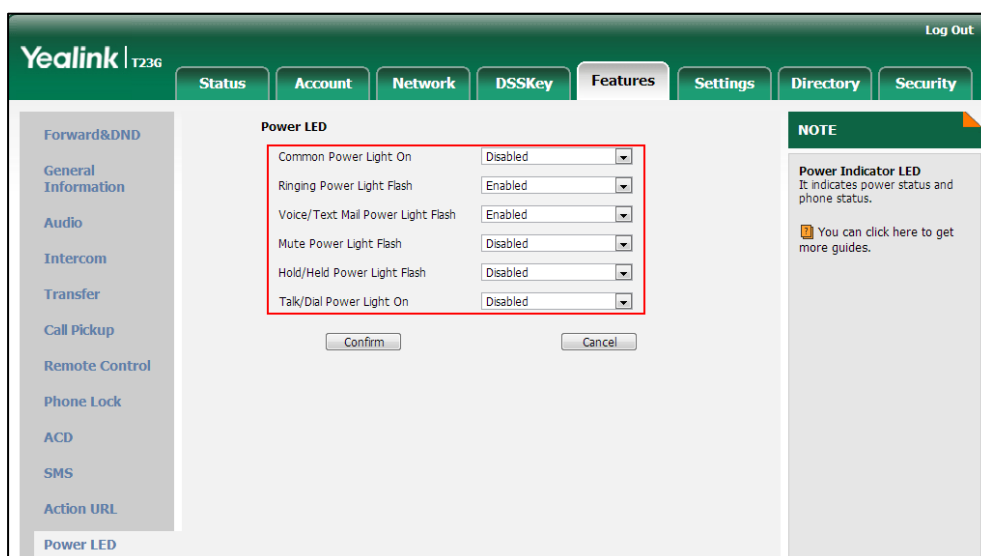

8. Click **Confirm** to accept the change.

Notification Popups

Notification popups feature allows the IP phone to display the pop-up message when it misses a call, forwards an incoming call to other party or receives a new voice mail or a new text message.

Procedure

Notification popups can be configured using the configuration files or locally.

Configuration File	<y0000000000xx>.cfg	Configure notification popups. Parameters: features.voice_mail_popup.enable features.missed_call_popup.enable features.forward_call_popup.enable features.text_message_popup.enable
Local	Web User Interface	Configure notification popups. Navigate to: http://<phoneIPAddress>/servlet?p=features-notifypop&q=load

Details of Configuration Parameters:

Parameters	Permitted Values	Default
features.voice_mail_popup.enable	0 or 1	1
<p>Description: Enables or disables the IP phone to display the pop-up message box when it receives a new voice mail.</p> <p>0-Disabled 1-Enabled</p> <p>Note: If the voice mail pop-up message box disappears, it won't pop up again unless the user receives a new voice mail or the user re-registers the account that has unread voice mail(s).</p> <p>Web User Interface: Features->Notification Popups->Display Voice Mail Popup</p> <p>Phone User Interface: None</p>		
features.missed_call_popup.enable	0 or 1	1
<p>Description: Enables or disables the IP phone to display the pop-up message box when it misses a call.</p> <p>0-Disabled 1-Enabled</p> <p>Web User Interface: Features->Notification Popups->Display Missed Call Popup</p> <p>Phone User Interface: None</p>		
features.forward_call_popup.enable	0 or 1	1
<p>Description: Enables or disables the IP phone to display the pop-up message box when it forwards an incoming call to other party.</p> <p>0-Disabled 1-Enabled</p> <p>Web User Interface: Features->Notification Popups->Display Forward Call Popup</p>		

Parameters	Permitted Values	Default
Phone User Interface: None		
features.text_message_popup.enable	0 or 1	1
<p>Description: Enables or disables the IP phone to display the pop-up message box when it receives a new text message.</p> <p>0-Disabled 1-Enabled</p> <p>Note: It works only if the value of the parameter “features.text_message.enable” is set to 1 (Enabled).</p> <p>Web User Interface: Features->Notification Popups->Display Text Message Popup</p> <p>Phone User Interface: None</p>		

To configure the notification popups via web user interface:

1. Click on **Features->Notification Popups**.
2. Select the desired value from the pull-down list of **Display Voice Mail Popup**.
3. Select the desired value from the pull-down list of **Display Missed Call Popup**.
4. Select the desired value from the pull-down list of **Display Forward Call Popup**.
5. Select the desired value from the pull-down list of **Display Text Message Popup**.

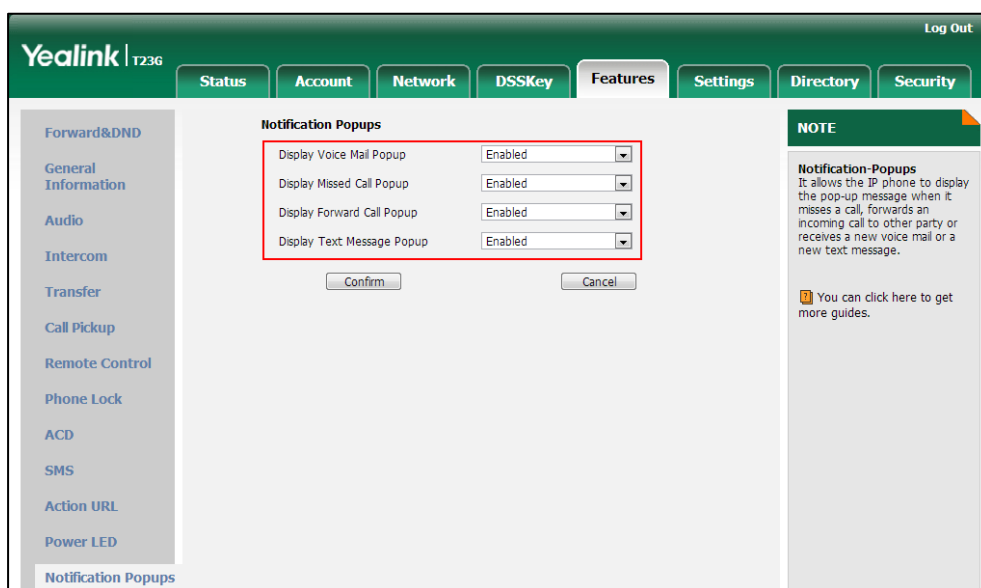

6. Click **Confirm** to accept the change.

Contrast

Contrast determines the readability of the texts displayed on the LCD screen. Adjusting the contrast to a comfortable level can optimize the screen viewing experience. When configured properly, contrast allows users to read the LCD's display with minimal eyestrain. You can configure the LCD's contrast of SIP-T27P, SIP-T23P/G, SIP-T21(P) E2 and SIP-T19(P) E2 IP phones, EXP39 connected to SIP-T29G/T27P IP phones and EXP40 connected to SIP-T48G/T46G IP phones. Make sure the expansion module has been connected to the IP phone before adjustment.

Procedure

Contrast can be configured using the configuration files or locally.

Configuration File	<y0000000000xx>.cfg	Configure the contrast of the LCD screen. Parameter: phone_setting.contrast
Local	Web User Interface	Configure the contrast of the LCD screen. Navigate to: http://<phoneIPAddress>/servlet?p=settings-preference&q=load
	Phone User Interface	Configure the contrast of the LCD screen.

Details of the Configuration Parameter:

Parameter	Permitted Values	Default
phone_setting.contrast	Integer from 1 to 10	6
<p>Description: Configures the contrast of the LCD screen. For T48G/T46G IP phones, it configures the LCD's contrast of the connected EXP40 only. For T29G IP phones, it configures the LCD's contrast of the connected EXP39 only. For T27P IP phones, it configures the LCD's contrast of the IP phone and the connected EXP39. For T23P/T23G/T21(P) E2/T19(P) E2 IP phones, it configures the LCD's contrast of the IP phone.</p>		

Parameter	Permitted Values	Default
<p>Note: We recommend that you set the contrast of the LCD screen to 6 as a more comfortable level.</p> <p>Web User Interface: Settings->Preference->Contrast</p> <p>Phone User Interface: Menu->Settings->Basic Settings->Display->Contrast</p>		

To configure contrast via web user interface:

1. Click on **Settings->Preference**.
2. Select the desired value from the pull-down list of **Contrast**.

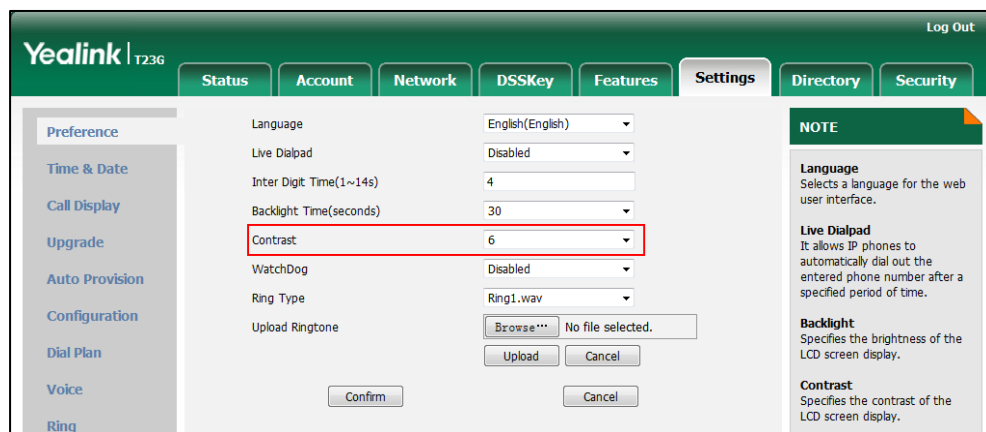

3. Click **Confirm** to accept the change.

To configure contrast via phone user interface:

1. Press **Menu->Settings->Basic Settings->Display->Contrast**.
2. Press **◀** or **▶**, or the **Switch** soft key to increase or decrease the intensity of contrast.

The default contrast level is 6.

3. Press the **Save** soft key to accept the change.

Wallpaper

Wallpaper is an image used as the background of the IP phone idle screen. Users can select an image from IP phone's built-in background or customize wallpaper from personal pictures. To set the custom wallpaper as the IP phone background, you need to upload the custom wallpaper to the IP phone in advance. The wallpaper is only applicable to SIP-T48G, SIP-T46G and SIP-T29G IP phones.

The wallpaper image format must meet the following:

Phone Model	Format	Resolution	Single File Size	Total File Size
SIP-T48G	.jpg/.png/.bmp	<=800*480	<=5MB	<=20MB
SIP-T46G/T29G	.jpg/.png/.bmp	<=480*272	<=5MB	<=20MB

Procedure

Wallpaper can be configured using the configuration files or locally.

Local	Web User Interface	<p>Configure the wallpaper displayed on the IP phone.</p> <p>Parameter: phone_setting.backgrounds</p> <p>Specify the access URL of the custom wallpaper.</p> <p>Parameter: wallpaper_upload.url</p>
	Phone User Interface	<p>Configure the wallpaper displayed on the IP phone.</p> <p>Upload the custom wallpaper.</p> <p>Navigate to: http://<phoneIPAddress>/servlet?p=settings-preference&q=load</p>
Configuration File	<y0000000000xx>.cfg	<p>Configure the wallpaper displayed on the IP phone.</p> <p>Parameter: phone_setting.backgrounds</p> <p>Specify the access URL of the custom wallpaper.</p> <p>Parameter: wallpaper_upload.url</p>

Details of the Configuration Parameter:

Parameters	Permitted Values	Default
phone_setting.backgrounds	Refer to the following content	Refer to the following content
<p>Description: Configures the wallpaper displayed on the IP phone.</p> <p>Example: For SIP-T46G/T29G: To set a phone built-in picture (e.g., 01.jpg) to be wallpaper, the value format is: phone_setting.backgrounds = Resource:01.jpg</p>		

Parameters	Permitted Values	Default
<p>To configure a custom picture (e.g., custom1.jpg) to be wallpaper, the value format is: phone_setting.backgrounds = Config:custom1.jpg</p> <p>Permitted Values:</p> <p>Resource:X (Valid values of X are: Default.jpg, 01.jpg, 02.jpg, 03.jpg, 04.jpg, 05.jpg, 06.jpg, 07.jpg, 08.jpg, 09.jpg or 10.jpg) or Config:wallpaper name</p> <p>The default value is Default.jpg.</p> <p>For SIP-T48G:</p> <p>To configure a phone built-in picture (e.g., 1.png) to be wallpaper, the value format is: phone_setting.backgrounds = Resource:1.png</p> <p>To configure a custom picture (e.g., custom1.png) to be wallpaper, the value format is: phone_setting.backgrounds = Config:custom1.png</p> <p>Permitted Values:</p> <p>Resource:X (Valid values of X are: Default.png, 1.png, 2.png, 3.png, 4.png, 5.png, 6.png, 7.png, 8.png or 9.png) or Config:wallpaper name</p> <p>The default value is Default.png.</p> <p>Note: It is only applicable to SIP-T48G/T46G/T29G IP phones.</p> <p>Web User Interface:</p> <p>Settings->Preference->Wallpaper</p> <p>Phone User Interface:</p> <p>Menu->Basic->Display->Wallpaper</p>		
wallpaper_upload.url	URL within 511 characters	Blank
<p>Description:</p> <p>Configures the access URL of the wallpaper image.</p> <p>Example:</p> <p>wallpaper_upload.url = http://192.168.10.25/wallpaper.jpg</p> <p>Note: It is only applicable to SIP-T48G/46G/T29G IP phones.</p> <p>Web User Interface:</p> <p>Settings->Preference->Upload Wallpaper(480*272)</p> <p>Phone User Interface:</p> <p>None</p>		

To upload custom wallpaper via web user interface:

1. Click on **Settings->Preference**.
2. In the **Upload Wallpaper** field, click **Browse** to locate the wallpaper image from your local system.

3. Click **Upload** to upload the file.

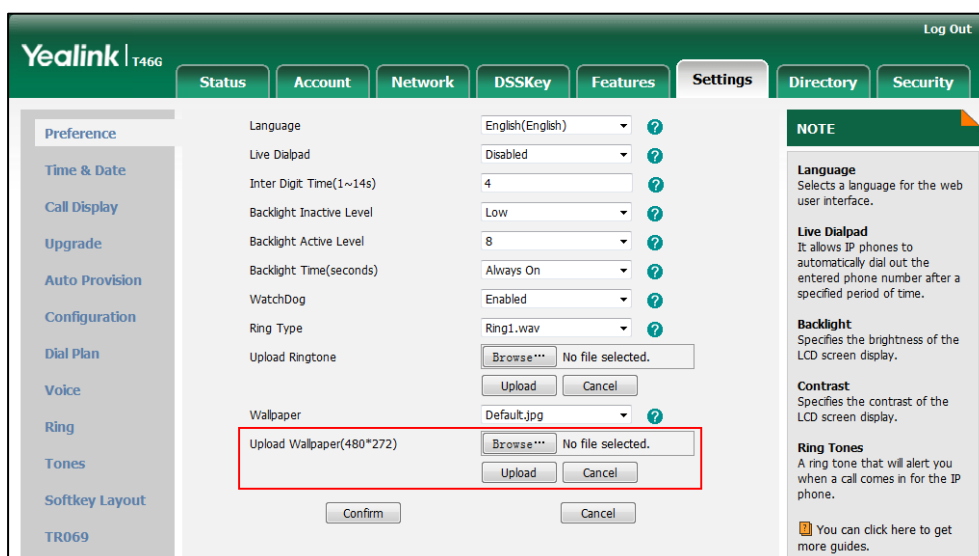

4. Click **Confirm** to accept the change.

The custom wallpaper appears in the pull-down list of **Wallpaper**.

To change the wallpaper via web user interface:

1. Click on **Settings->Preference**.
2. Select the desired wallpaper from the pull-down list of **Wallpaper**.

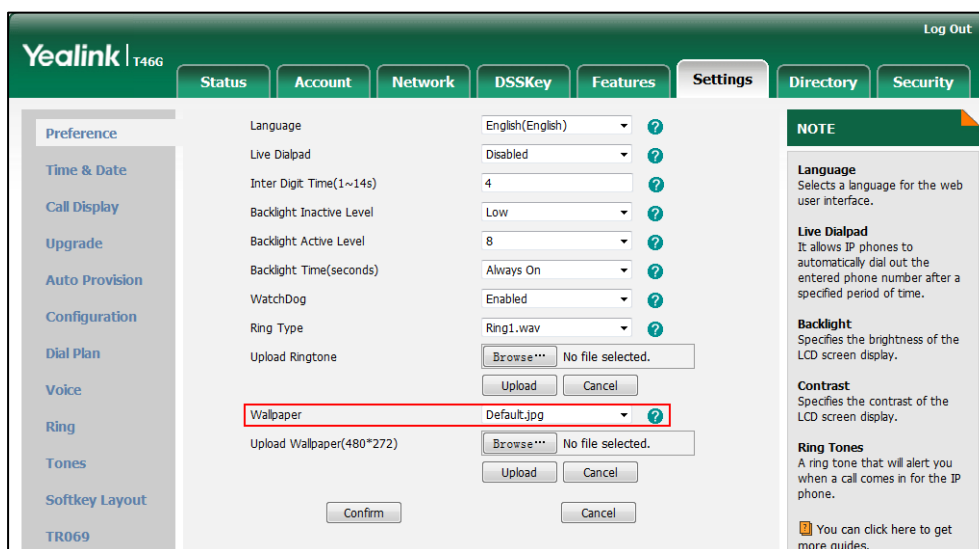

3. Click **Confirm** to accept the change.

To change the wallpaper via phone user interface:

1. Press **Menu->Basic->Display->Wallpaper**.
2. Press **←** or **→**, or the **Switch** soft key to select the desired wallpaper.
3. Press the **Save** soft key to accept the change.

Backlight

Backlight determines the brightness of the LCD screen display, allowing users to read easily in dark environments. Backlight time specifies the delay time to change the intensity of the LCD screen when the IP phone is inactive. Backlight turns off quickly if a short backlight time is configured, this may not give users enough time to read messages. Backlight time is applicable to SIP-T48G/T46G/T42G/T41P/T29G/T27P/T23P/T23G/T21(P) E2 IP phones and EXP40 connected to SIP-T48G/T46G IP phones and EXP39 connected to SIP-T29G/T27P IP phones.

You can configure the backlight time as one of the following types:

- **Always Off:** Backlight is turned off permanently (not applicable to SIP-T48G/T46G/T29G IP phones).
- **Always On:** Backlight is turned on permanently.
- **15s, 30s, 60s, 120s, 300s, 600s or 1800s:** Backlight is turned off when the IP phone is inactive after a preset period of time (in seconds), but it is automatically turned on if the status of the IP phone changes or any key is pressed.

Backlight Active Level is used to adjust the backlight intensity of the LCD screen when the phone is active. Backlight Inactive Level is used to adjust the backlight intensity of the LCD screen when the phone is inactive. Backlight Active Level is applicable to SIP-T48G/T46G IP phones and the connected EXP40, SIP-T29G/T27P IP phones and the connected EXP39. Backlight Inactive Level is only applicable to SIP-T48G, SIP-T46G and SIP-T29G IP phones.

Note

It is not applicable to SIP-T19(P) E2 IP phones.

Before you adjust the LCD's backlight of expansion module, make sure the expansion module has been connected to the IP phone.

The following table lists available methods and configuration options to configure the backlight of phone models/expansion modules.

Phone Model (and the connected expansion module)	Configuration Methods	Configuration Options
SIP-T48G/T46G/T29G	Configuration Files Web User Interface Phone User Interface	Backlight Inactive Level
SIP-T48G(EXP40)/T46G(EXP40)/T29G(EXP39)	Configuration Files Web User Interface Phone User Interface	Backlight Active Level Backlight Time
SIP-T27P(EXP39)	Configuration Files Phone User Interface	Backlight Active Level Backlight Time

Phone Model (and the connected expansion module)	Configuration Methods	Configuration Options
	Web User Interface	
SIP-T42G/T41P/T23P/T23G/T21(P) E2	Configuration Files Web User Interface Phone User Interface	Backlight Time

Procedure

Backlight can be configured using the configuration files or locally.

Configuration File	<y0000000000xx>.cfg	Configure the backlight of the LCD screen. Parameters: phone_setting.active_backlight_level phone_setting.inactive_backlight_level phone_setting.backlight_time
Local	Web User Interface	Configure the backlight of the LCD screen. Navigate to: http://<phoneIPAddress>/servlet?p=settings-preference&q=load
	Phone User Interface	Configure the backlight of the LCD screen.

Details of Configuration Parameters:

Parameters	Permitted Values	Default
phone_setting.active_backlight_level	Integer from 1 to 10	8
<p>Description: Configures the intensity of the LCD screen when the phone is active. 10 is the highest intensity. For T48G/T46G IP phones, it configures the LCD's intensity of the IP phone and the connected EXP40. For T29G/T27P IP phones, it configures the LCD's intensity of the IP phone and the connected EXP39.</p> <p>Note: It is not applicable to SIP-T19(P) E2 IP phones.</p> <p>Web User Interface:</p>		

Settings->Preference->Backlight Active Level Phone User Interface: Menu->Basic->Display->Backlight->Backlight Active Level		
phone_setting.inactive_backlight_level	0 or 1	1
<p>Description: Configures the intensity of the LCD screen when the phone is inactive.</p> <p>0-Off 1-Low</p> <p>Note: It is only applicable to SIP-T48G/T46G/T29G IP phones.</p> <p>Web User Interface: Settings->Preference->Backlight Inactive Level</p> <p>Phone User Interface: Menu->Basic->Display->Backlight->Backlight Inactive Level</p>		
phone_setting.backlight_time	0, 1, 15, 30, 60, 120, 300, 600 or 1800	Refer to the following content
<p>Description: Configures the delay time (in seconds) to change the intensity of the LCD screen when the IP phone is inactive.</p> <p>0-Always on 1-Always off (not applicable to SIP-T48G/T46G/T29G IP phones)</p> <p>15-15s 30-30s 60-60s 120-120s 300-300s 600-600s 1800-1800s</p> <p>If it is set to 60 (60s), the intensity of the LCD screen will be changed when the IP phone has been inactivated for 60 seconds.</p> <p>For SIP-T48G/T46G/T42G/T41P/T29G: The default value is 0.</p> <p>For SIP-T27P/T23P/T23G/T21(P) E2: The default value is 30.</p> <p>Note: It is not applicable to SIP-T19(P) E2 IP phones.</p>		

Web User Interface:

Settings->Preference->Backlight Time(seconds)

Phone User Interface:

Menu->Settings->Basic Settings->Display->Backlight->Backlight Time

To configure backlight via web user interface (take SIP-T23G IP phones for example):

1. Click on **Settings->Preference**.
2. Select the desired value from the pull-down list of **Backlight Time(seconds)**.

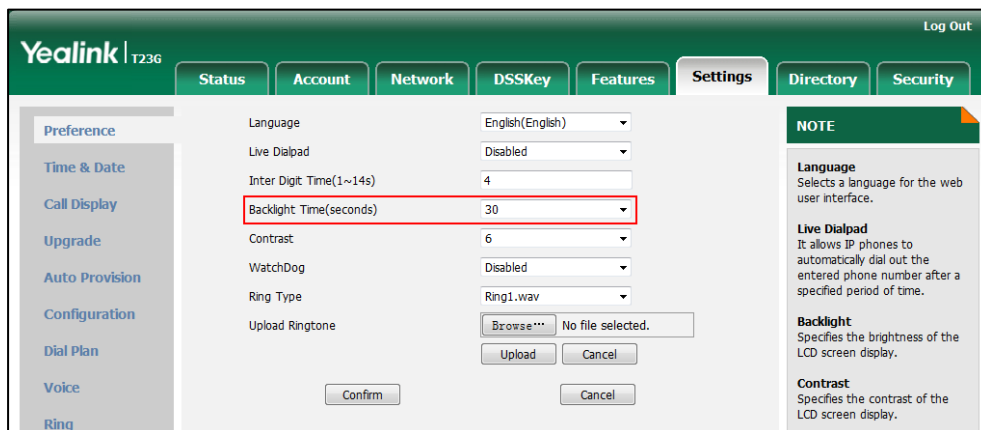

3. Click **Confirm** to accept the change.

To configure backlight via phone user interface (take SIP-T23G IP phones for example):

1. Press **Menu->Settings->Basic Settings->Display->Backlight**.
2. Press **◀** or **▶**, or the **Switch** soft key to select the desired value from the **Backlight Time** field.
3. Press the **Save** soft key to accept the change.

To configure the backlight via web user interface (take SIP-T46G IP phones for example):

1. Click on **Settings->Preference**.
2. Select the desired value from the pull-down list of **Backlight Inactive Level**.
3. Select the desired value from the pull-down list of **Backlight Active Level**.

- Select the desired value from the pull-down list of **Backlight Time(seconds)**.

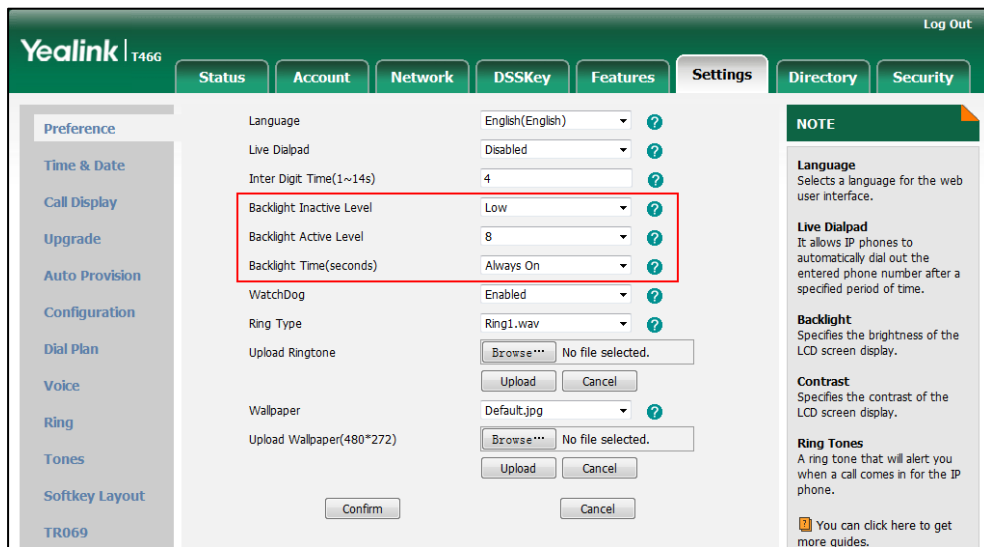

- Click **Confirm** to accept the change.

To configure the backlight via phone user interface (take SIP-T46G IP phones for example):

- Press **Menu->Basic->Display->Backlight**.
- Press **◀** or **▶** , or the **Switch** soft key to select the desired level from the **Backlight Active Level** field.
- Press **◀** or **▶** , or the **Switch** soft key to select the desired value from the **Backlight Inactive Level** field.
- Press **◀** or **▶** , or the **Switch** soft key to select the desired time from the **Backlight Time** field.
- Press the **Save** soft key to accept the change.

Bluetooth

Bluetooth enables low-bandwidth wireless connections within a range of 10 meters (32 feet). The best performance is in the 1 to 2 meter (3 to 6 feet) range. You can activate/deactivate the Bluetooth mode and then pair and connect the Bluetooth headset with your phone. It is only applicable to SIP-T48G/T46G/T29G IP phones.

Note To use this feature, make sure the Bluetooth USB dongle is properly connected to the USB port on the back of the phone.

Procedure

Bluetooth mode can be configured using the configuration files or locally.

Configuration File	<y0000000000xx>.cfg	Configure Bluetooth mode.
---------------------------	---------------------	---------------------------

		Parameter: features.bluetooth_enable
Local	Web User Interface	Configure Bluetooth mode. Navigate to: http://<phoneIPAddress>/servlet ?p=features-bluetooth&q=load
	Phone User Interface	Configure Bluetooth mode.

Details of the Configuration Parameter:

Parameter	Permitted Values	Default
features.bluetooth_enable	0 or 1	0
<p>Description: Triggers Bluetooth mode to on or off.</p> <p>0-Off 1-On</p> <p>Web User Interface: Features->Bluetooth->Bluetooth Active</p> <p>Phone User Interface: Menu->Basic->Bluetooth</p>		

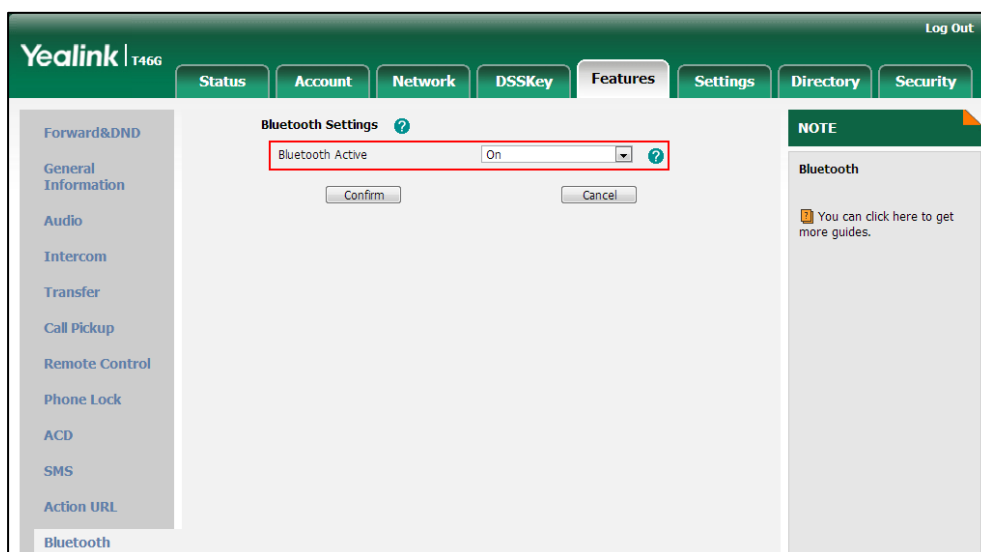

To active the Bluetooth mode via web user interface:

1. Click on **Features->Bluetooth**.
2. Select the desired value from the pull-down list of **Bluetooth Active**.



3. Click **Confirm** to accept the change.



To active the Bluetooth mode via phone user interface:

1. Press **Menu->Basic->Bluetooth**.
2. Press  or , or the **Switch** soft key to select **On** from the **Bluetooth** field.
3. Press the **Save** soft key to accept the change.

Enable Page Tips

Enable page tips feature allows users to enable the page icon and page switch key LED to indicate different statuses. It is mainly used in the scenario of configuring multi-page line key. It is only applicable to SIP-T46G/T29G/T42G/T41P/T27P IP phones.

The following table lists the page icons to indicate different statuses:

Icons	Description
	Fast flashing: the BLF monitored user receives an incoming call on the non-current page. Solid: there is a parked call to the line on the non-current page.
	Fast flashing: the line receives an incoming call on the non-current page.

Procedure

Enable page tips can be configured using the configuration files or locally.

Configuration File	<y0000000000xx>.cfg	Configure enable page tips. Parameter: phone_setting.page_tip
Local	Web User Interface	Configure enable page tips. Navigate to: http://<phoneIPAddress>/servlet ?p=dsskey&model=1&q=load&linepage=1

Details of the Configuration Parameter:

Parameter	Permitted Values	Default
phone_setting.page_tip	0 or 1	0
Description:		

Parameter	Permitted Values	Default
<p>Enables or disables the page icon and page switch key LED to indicate different states of line keys on the non-current page.</p> <p>0-Disabled 1-Enabled</p> <p>Note: It is only applicable to SIP-T46G/T29G/T42G/T41P/T27P IP phones.</p> <p>Web User Interface: DSSKey->Line Key->Enable Page Tips</p> <p>Phone User Interface: None</p>		

To configure the page icon to indicate status via web user interface:

1. Click on **DSSKey->Line Key**.
2. Select **Enabled** from the pull-down list of **Enable Page Tips**.

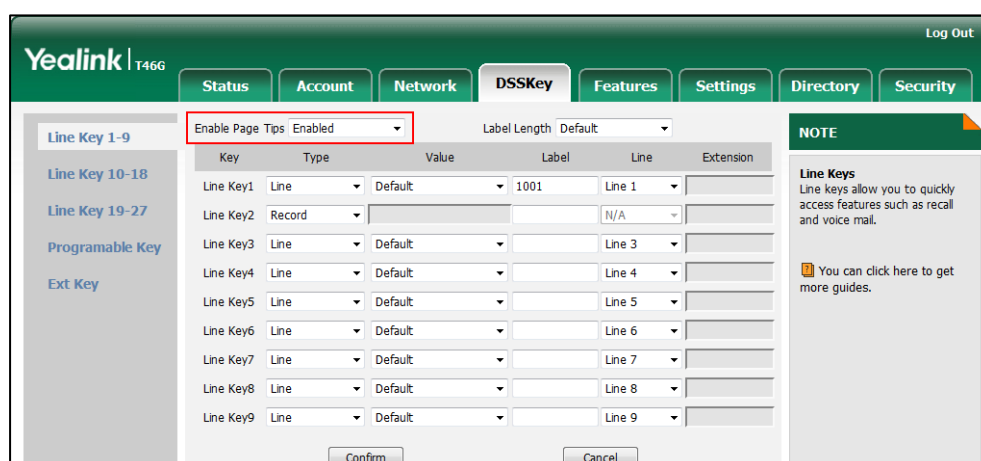

3. Click **Confirm** to accept the change.

Label Length

Label length allows IP phones to extend the display length of the line key label. If the label length feature is enabled, more characters will be displayed on the idle LCD screen. It is only applicable to SIP-T48G/T46G/T29G IP phones.

Procedure

Label length can be configured using the configuration files or locally.

Configuration File	<code><y0000000000xx>.cfg</code>	Configure label length. Parameter: features.config_dsskey_length
---------------------------	--	---

Local	Web User Interface	Configure label length. Navigate to: http://<phoneIPAddress>/servlet ?p=dsskey&model=1&q=load&li nepage=1
-------	--------------------	--

Details of the Configuration Parameter:

Parameter	Permitted Values	Default
features.config_dsskey_length	0 or 1	0
<p>Description: Enables or disables the extended length of the label displayed on the idle LCD screen for the line key.</p> <p>0-Default 1-Extended</p> <p>Note: It is only applicable to SIP-T48G/T46G/T29G IP phones.</p> <p>Web User Interface: DSSKey->Line Key->Label Length</p> <p>Phone User Interface: None</p>		

To configure the label length via web user interface:

1. Click on **DSSKey->Line Key**.
2. Select **Extended** from the pull-down list of **Label Length**.

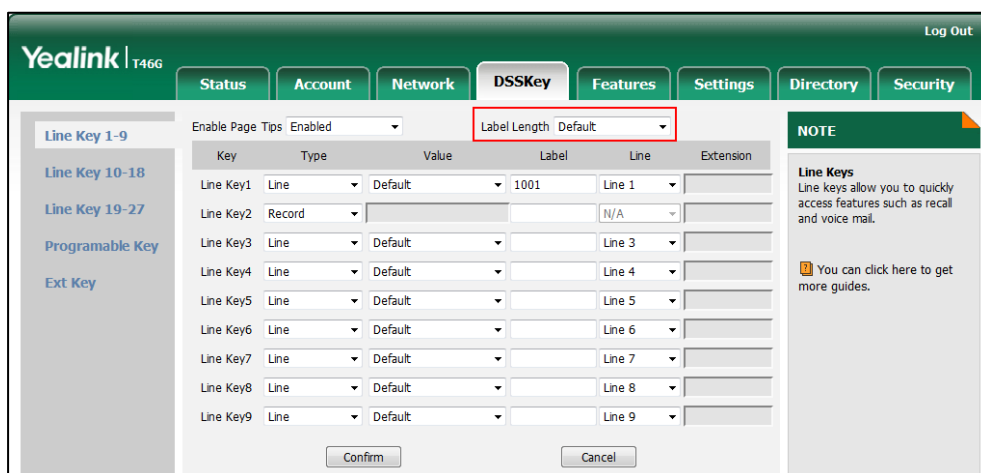

3. Click **Confirm** to accept the change.

Account Registration

Registering a SIP account makes it easier for the IP phones to receive an incoming call, dial an outgoing call. The IP phones support SIP server redundancy for account registration. For more information, refer to [Server Redundancy](#) on page 534.

Procedure

Account registration can be configured using the configuration files or locally.

Configuration File	<MAC>.cfg	<p>Configure the account registration information.</p> <p>Parameter:</p> <ul style="list-style-type: none"> account.X.enable account.X.label account.X.display_name account.X.auth_name account.X.user_name account.X.password account.X.sip_server.Y.address account.X.sip_server.Y.port account.X.outbound_proxy_enable account.X.outbound_host account.X.outbound_port account.X.backup_outbound_host account.X.backup_outbound_port <p>Configure the interval for the IP phone to retry to re-register when registration fails.</p> <p>Parameter:</p> <ul style="list-style-type: none"> account.X.reg_fail_retry_interval <p>Configure the number of DSS keys to be assigned automatically.</p> <p>Parameter:</p> <ul style="list-style-type: none"> account.X.number_of_linekey
	<y0000000000xx>.cfg	<p>Configure auto linekeys.</p> <p>Parameter:</p> <ul style="list-style-type: none"> features.auto_linekeys.enable
Local	Web User Interface	Configure the account registration information.

		<p>Navigate to: <a href="http://<phoneIPAddress>/servlet?p=account-register&q=load&acc=0">http://<phoneIPAddress>/servlet?p=account-register&q=load&acc=0 Configure auto linekeys.</p> <p>Navigate to: <a href="http://<phoneIPAddress>/servlet?p=features-general&q=load">http://<phoneIPAddress>/servlet?p=features-general&q=load Configure the interval for the IP phone to retry to register when registration fails. Configure the number of DSS keys to be assigned automatically.</p> <p>Navigate to: <a href="http://<phoneIPAddress>/servlet?p=account-adv&q=load&acc=0">http://<phoneIPAddress>/servlet?p=account-adv&q=load&acc=0</p>
	Phone User Interface	Configure the account registration information.

Details of Configuration Parameters:

Parameters	Permitted Values	Default
account.X.enable	0 or 1	0
<p>Description: Enables or disables the account X. 0-Disabled 1-Enabled X ranges from 1 to 16 (for SIP-T48G/T46G/T29G) X ranges from 1 to 12 (for SIP-T42G) X ranges from 1 to 6 (for SIP-T41P/T27P) X ranges from 1 to 3 (for SIP-T23P/G) X ranges from 1 to 2 (for SIP-T21(P) E2) X is equal to 1 (for SIP-T19(P) E2)</p> <p>Web User Interface: Account->Register->Line Active</p> <p>Phone User Interface: Menu->Settings->Advanced Settings->Accounts->Active Line</p>		

Parameters	Permitted Values	Default
account.X.label	String within 99 characters	Blank
<p>Description: (Optional.) Configures the label to be displayed on the LCD screen for account X. X ranges from 1 to 16 (for SIP-T48G/T46G/T29G) X ranges from 1 to 12 (for SIP-T42G) X ranges from 1 to 6 (for SIP-T41P/T27P) X ranges from 1 to 3 (for SIP-T23P/G) X ranges from 1 to 2 (for SIP-T21(P) E2) X is equal to 1 (for SIP-T19(P) E2)</p> <p>Web User Interface: Account->Register->Label</p> <p>Phone User Interface: Menu->Settings->Advanced Settings->Accounts->Label</p>		
account.X.display_name	String within 99 characters	Blank
<p>Description: Configures the display name for account X. X ranges from 1 to 16 (for SIP-T48G/T46G/T29G) X ranges from 1 to 12 (for SIP-T42G) X ranges from 1 to 6 (for SIP-T41P/T27P) X ranges from 1 to 3 (for SIP-T23P/G) X ranges from 1 to 2 (for SIP-T21(P) E2) X is equal to 1 (for SIP-T19(P) E2)</p> <p>Web User Interface: Account->Register->Display Name</p> <p>Phone User Interface: Menu->Settings->Advanced Settings->Accounts->Display Name</p>		
account.X.auth_name	String within 99 characters	Blank
<p>Description: Configures the user name for register authentication for account X. X ranges from 1 to 16 (for SIP-T48G/T46G/T29G) X ranges from 1 to 12 (for SIP-T42G)</p>		

Parameters	Permitted Values	Default
<p>X ranges from 1 to 6 (for SIP-T41P/T27P) X ranges from 1 to 3 (for SIP-T23P/G) X ranges from 1 to 2 (for SIP-T21(P) E2) X is equal to 1 (for SIP-T19(P) E2)</p> <p>Web User Interface: Account->Register->Register Name</p> <p>Phone User Interface: Menu->Settings->Advanced Settings->Accounts->Register Name</p>		
account.X.user_name	String within 99 characters	Blank
<p>Description: Configures the register user name for account X.</p> <p>X ranges from 1 to 16 (for SIP-T48G/T46G/T29G) X ranges from 1 to 12 (for SIP-T42G) X ranges from 1 to 6 (for SIP-T41P/T27P) X ranges from 1 to 3 (for SIP-T23P/G) X ranges from 1 to 2 (for SIP-T21(P) E2) X is equal to 1 (for SIP-T19(P) E2)</p> <p>Web User Interface: Account->Register->User Name</p> <p>Phone User Interface: Menu->Settings->Advanced Settings->Accounts->User Name</p>		
account.X.password	String within 99 characters	Blank
<p>Description: Configures the password for register authentication for account X.</p> <p>X ranges from 1 to 16 (for SIP-T48G/T46G/T29G) X ranges from 1 to 12 (for SIP-T42G) X ranges from 1 to 6 (for SIP-T41P/T27P) X ranges from 1 to 3 (for SIP-T23P/G) X ranges from 1 to 2 (for SIP-T21(P) E2) X is equal to 1 (for SIP-T19(P) E2)</p> <p>Web User Interface: Account->Register->Password</p>		

Parameters	Permitted Values	Default
<p>Phone User Interface: Menu->Settings->Advanced Settings->Accounts->Password</p>		
<p>account.X.sip_server.Y.address (X ranges from 1 to 16, Y ranges from 1 to 2)</p>	<p>String within 256 characters</p>	<p>Blank</p>
<p>Description: Configures the IP address or domain name of the SIP server Y for account X. X ranges from 1 to 16 (for SIP-T48G/T46G/T29G) X ranges from 1 to 12 (for SIP-T42G) X ranges from 1 to 6 (for SIP-T41P/T27P) X ranges from 1 to 3 (for SIP-T23P/G) X ranges from 1 to 2 (for SIP-T21(P) E2) X is equal to 1 (for SIP-T19(P) E2)</p> <p>Example: account.1.sip_server.1.address = yealink.pbx.com</p> <p>Web User Interface: Account->Register->SIP Server Y->Server Host</p> <p>Phone User Interface: Menu->Settings->Advanced Settings->Accounts->SIP ServerY</p>		
<p>account.X.sip_server.Y.port (X ranges from 1 to 16, Y ranges from 1 to 2)</p>	<p>Integer from 0 to 65535</p>	<p>5060</p>
<p>Description: Configures the port of the SIP server Y for account X. X ranges from 1 to 16 (for SIP-T48G/T46G/T29G) X ranges from 1 to 12 (for SIP-T42G) X ranges from 1 to 6 (for SIP-T41P/T27P) X ranges from 1 to 3 (for SIP-T23P/G) X ranges from 1 to 2 (for SIP-T21(P) E2) X is equal to 1 (for SIP-T19(P) E2)</p> <p>Example: account.1.sip_server.1.port = 5060</p> <p>Web User Interface: Account->Register->SIP Server Y->Port</p> <p>Phone User Interface: None</p>		

Parameters	Permitted Values	Default
account.X.outbound_proxy_enable	0 or 1	0
<p>Description: Enables or disables the IP phone to send requests to the outbound proxy server 1 for account X. 0-Disabled 1-Enabled X ranges from 1 to 16 (for SIP-T48G/T46G/T29G) X ranges from 1 to 12 (for SIP-T42G) X ranges from 1 to 6 (for SIP-T41P/T27P) X ranges from 1 to 3 (for SIP-T23P/G) X ranges from 1 to 2 (for SIP-T21(P) E2) X is equal to 1 (for SIP-T19(P) E2)</p> <p>Web User Interface: Account->Register->Enable Outbound Proxy Server</p> <p>Phone User Interface: Menu->Settings->Advanced Settings->Accounts->Outbound Status</p>		
account.X.outbound_host	IP address or domain name	Blank
<p>Description: Configures the IP address or domain name of the outbound proxy server 1 or account X. X ranges from 1 to 16 (for SIP-T48G/T46G/T29G) X ranges from 1 to 12 (for SIP-T42G) X ranges from 1 to 6 (for SIP-T41P/T27P) X ranges from 1 to 3 (for SIP-T23P/G) X ranges from 1 to 2 (for SIP-T21(P) E2) X is equal to 1 (for SIP-T19(P) E2)</p> <p>Note: It works only if the value of the parameter "account.X.outbound_proxy_enable" is set to 1 (Enabled).</p> <p>Web User Interface: Account->Register->Outbound Proxy Server 1</p> <p>Phone User Interface: Menu->Settings->Advanced Settings->Accounts->Outbound Proxy1</p>		

Parameters	Permitted Values	Default
account.X.outbound_port	Integer from 0 to 65535	5060
<p>Description: Configures the port of the outbound proxy server for account X. X ranges from 1 to 16 (for SIP-T48G/T46G/T29G) X ranges from 1 to 12 (for SIP-T42G) X ranges from 1 to 6 (for SIP-T41P/T27P) X ranges from 1 to 3 (for SIP-T23P/G) X ranges from 1 to 2 (for SIP-T21(P) E2) X is equal to 1 (for SIP-T19(P) E2)</p> <p>Example: account.1.outbound_port = 5060</p> <p>Note: It works only if the value of the parameter "account.X.outbound_proxy_enable" is set to 1 (Enabled).</p> <p>Web User Interface: Account->Register->Outbound Proxy Server 1->Port</p> <p>Phone User Interface: None</p>		
account.X.backup_outbound_host	IP address or domain name	Blank
<p>Description: Configures the IP address or domain name of the outbound proxy server 2 for account X. X ranges from 1 to 16 (for SIP-T48G/T46G/T29G) X ranges from 1 to 12 (for SIP-T42G) X ranges from 1 to 6 (for SIP-T41P/T27P) X ranges from 1 to 3 (for SIP-T23P/G) X ranges from 1 to 2 (for SIP-T21(P) E2) X is equal to 1 (for SIP-T19(P) E2)</p> <p>Example: account.1.backup_outbound_host = 5060</p> <p>Note: It works only if the value of the parameter "account.X.outbound_proxy_enable" is set to 1 (Enabled).</p> <p>Web User Interface:</p>		

Parameters	Permitted Values	Default
Account->Register->Outbound Proxy Server 2 Phone User Interface: Menu->Settings->Advanced Settings->Accounts->Outbound Proxy2		
account.X.backup_outbound_port	Integer from 0 to 65535	5060
Description: Configures the port of the outbound proxy server 2 for account X. X ranges from 1 to 16 (for SIP-T48G/T46G/T29G) X ranges from 1 to 12 (for SIP-T42G) X ranges from 1 to 6 (for SIP-T41P/T27P) X ranges from 1 to 3 (for SIP-T23P/G) X ranges from 1 to 2 (for SIP-T21(P) E2) X is equal to 1 (for SIP-T19(P) E2) Example: account.1.backup_outbound_port = 5060 Note: It works only if the value of the parameter "account.X.outbound_proxy_enable" is set to 1 (Enabled). Web User Interface: Account->Register->Outbound Proxy Server 2->Port Phone User Interface: None		
account.X.reg_fail_retry_interval	Integer from 0 to 1800	30
Description: Configures the interval (in seconds) for the IP phone to retry to re-register for account X when registration fails. X ranges from 1 to 16 (for SIP-T48G/T46G/T29G) X ranges from 1 to 12 (for SIP-T42G) X ranges from 1 to 6 (for SIP-T41P/T27P) X ranges from 1 to 3 (for SIP-T23P/G) X ranges from 1 to 2 (for SIP-T21(P) E2) X is equal to 1 (for SIP-T19(P) E2) Example: account.1.reg_fail_retry_interval = 30		

Parameters	Permitted Values	Default
<p>Web User Interface: Account->Advanced->SIP Registration Retry Timer(0~1800s)</p> <p>Phone User Interface: None</p>		
account.X.number_of_linekey	String within 32 characters	1
<p>Description: Configures the number of DSS keys to be assigned with Line type automatically from the first unused one (unused one means the DSS key is configured as N/A or Line). If a DSS key is used, the IP phone will skip to the next unused DSS key. The order of DSS key assigned automatically is Line Key->Ext Key. X ranges from 1 to 16 (for SIP-T48G/T46G/T29G) X ranges from 1 to 12 (for SIP-T42G) X ranges from 1 to 6 (for SIP-T41P/T27P) X ranges from 1 to 3 (for SIP-T23P/G) X ranges from 1 to 2 (for SIP-T21(P) E2) X is equal to 1 (for SIP-T19(P) E2)</p> <p>Example: account.1.number_of_linekey = 2</p> <p>Note: It works only if the value of the parameter "features.auto_linekeys.enable" is set to 1 (Enabled). It is not applicable to SIP-T19(P) E2 IP phones.</p> <p>Web User Interface: Account->Advanced->Number of line key</p> <p>Phone User Interface: None</p>		
features.auto_linekeys.enable	0 or 1	0
<p>Description: Enables or disables the DSS keys to be assigned with Line type automatically. 0-Disabled 1-Enabled</p> <p>Note: The number of the DSS keys is determined by the value of the parameter "account.X.number_of_linekey". It is not applicable to SIP-T19(P) E2 IP phones.</p> <p>Web User Interface: Features->General Information->Auto Linekeys</p>		

Parameters	Permitted Values	Default
Phone User Interface:		
None		

To register an account via web user interface:

1. Click **Account->Register**.
2. Select the desired account from the pull-down list of **Account**.
3. Select **Enabled** from the pull-down list of **Line Active** field.
4. Enter the desired value in **Label**, **Display Name**, **Register Name**, **User Name**, **Password** and **SIP Server1/2** fields respectively.
5. If you use outbound proxy servers, do the following:
 - 1) Select **Enabled** from the pull-down list of **Enable Outbound Proxy Server**.
 - 2) Enter the desired IP address or domain name in the **Outbound Proxy Server 1/2** field and the desired port of the outbound proxy server 1/2 in the **Port** fields respectively.
 - 3) Enter the desired interval in the **Proxy Fallback Interval** field.

6. Click **Confirm** to accept the change.

To configure the interval for re-register when registration fails via web user interface:

1. Click **Account->Advanced**.

2. Enter the desired interval in the **SIP Registration Retry Timer(0~1800s)** field.

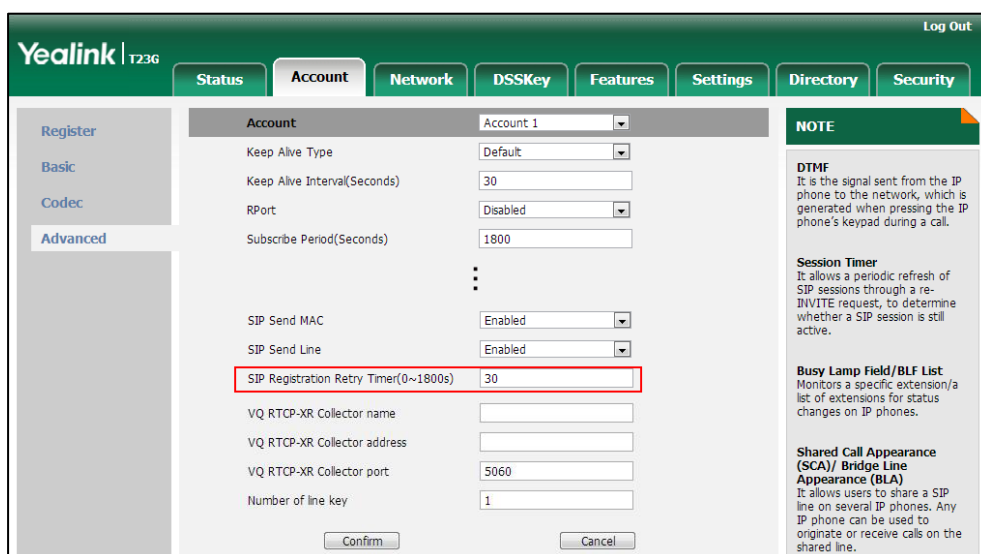

3. Click **Confirm** to accept the change.

To configure auto linekeys feature via web user interface:

1. Click on **Features->General Information**.
2. Select **Enabled** from the pull-down list of **Auto Linekeys**.

If **Auto LineKeys** is enabled, you can automatically assign multiple DSS keys with Line type for a registered line on the phone.

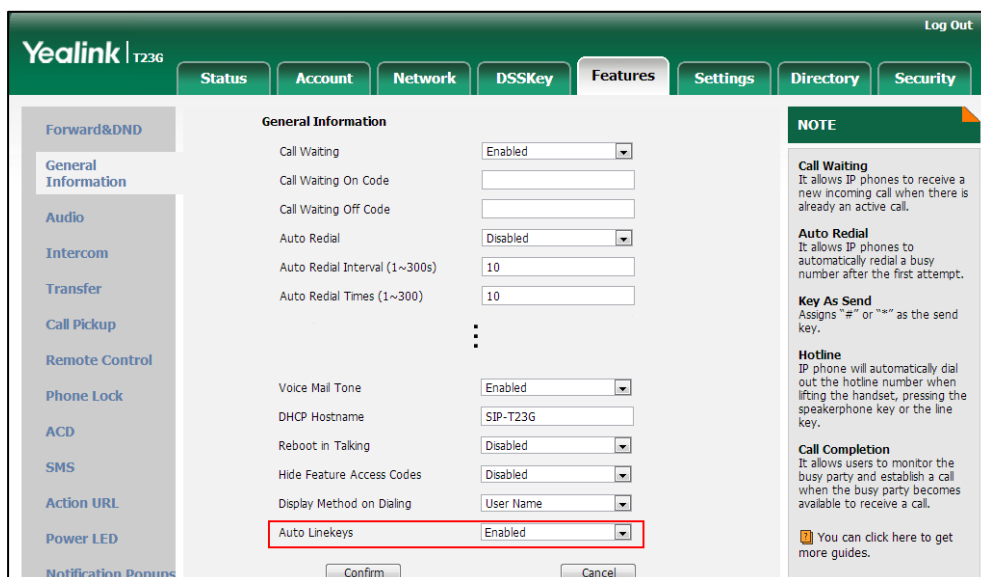

3. Click **Confirm** to accept the change.

To configure the number of line keys via web user interface:

1. Click **Account->Advanced**.
2. Enter the desired number in the **Number of line key** field.

This field appears only if **Auto Linekeys** is enabled.

The screenshot shows the Yealink T236 web interface. The 'Account' tab is active, and the 'Advanced' sub-tab is selected. The 'Number of line key' field is highlighted with a red box and contains the value '1'. Other visible fields include 'Keep Alive Type' (Default), 'Keep Alive Interval(Seconds)' (30), 'RPort' (Disabled), 'Subscribe Period(Seconds)' (1800), 'SIP Send MAC' (Enabled), 'SIP Send Line' (Enabled), 'SIP Registration Retry Timer(0~1800s)' (30), and 'VQ RTPC-XR Collector' fields (name, address, port: 5060). A 'NOTE' section on the right contains information about DTMF, Session Timer, Busy Lamp Field/BLF List, and Shared Call Appearance (SCA)/ Bridge Line Appearance (BLA).

3. Click **Confirm** to accept the change.

To register an account via phone user interface:

1. Press **Menu->Settings->Advanced Settings** (default password: admin) **->Accounts**.
2. Select the desired account and then press the **Enter** soft key.
3. Select **Enabled** from the **Active Line** field.
4. Enter the desired value in **Label**, **Display Name**, **Register Name**, **User Name**, **Password** and **SIP Server1/2** fields respectively. Contact your system administrator for more information.
5. If you use outbound proxy servers, do the following:
 - 1) Select **Enabled** from the **Outbound Status** field.
 - 2) Enter the desired IP address or domain name in the **Outbound Proxy1/2** field.
 - 3) Enter the desired interval in the **Proxy Fallback Interval** field.
6. Press the **Save** soft key to accept the change or the **Back** soft key to cancel.

Call Display

Display contact photo allows the IP phone to present the contact avatar when it receives an incoming call, dials an outgoing call or engages in a call. Display contact photo feature is only applicable to SIP-T48G/T46G/T29G IP phones.

Display called party information allows the IP phone to present the callee identity in

addition to the presentation of caller identity when it receives an incoming call.

The following figure shows an example of screen display when Display Called Party Information feature is enabled on the phone. The following shows an incoming call from 1008 to 1009.

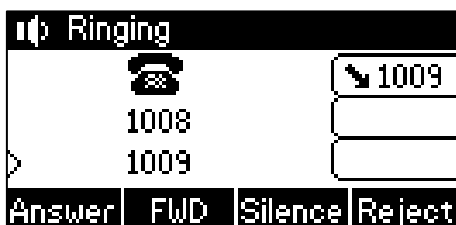

You can customize the call information to be displayed on the IP phone as required. IP phones support five call information display methods: Number+Name, Name, Name+Number, Number and Full Contact Info (display name<:sip:xxx@domain.com>).

Note SIP-T42G/T41P/T27P/T23P/T23G/T21(P) E2/T19(P) E2 IP phones have a limited display (up to three lines) due to their smaller screen size.

Procedure

Call Display can be configured using the configuration files or locally.

<p>Configuration File</p>	<p><y0000000000xx>.cfg</p>	<p>Configure display contact photo feature.</p> <p>Parameter: phone_setting.contact_photo_display.enable</p> <p>Configure display called party information feature.</p> <p>Parameter: phone_setting.called_party_info_display.enable</p> <p>Specify the call information display method.</p> <p>Parameter: phone_setting.call_info_display_method</p>
<p>Local</p>	<p>Web User Interface</p>	<p>Configure call display features.</p> <p>Navigate to: <a href="http://<phoneIPAddress>/servlet?p=settings-calldisplay&q=load">http://<phoneIPAddress>/servlet?p=settings-calldisplay&q=load</p>

Details of Configuration Parameters:

Parameters	Permitted Values	Default
<code>phone_setting.contact_photo_display.enable</code>	0 or 1	1
<p>Description: Enables or disables the IP phone to display contact avatar when it receives an incoming call, dials an outgoing call or engages in a call.</p> <p>0-Disabled 1-Enabled</p> <p>Note: It is only applicable to SIP-T48G/T46G/T29G IP phones.</p> <p>Web User Interface: Settings->Call Display->Display Contact Photo</p> <p>Phone User Interface: None</p>		
<code>phone_setting.called_party_info_display.enable</code>	0 or 1	0
<p>Description: Enables or disables the IP phone to display the called account information when receiving an incoming call.</p> <p>0-Disabled 1-Enabled</p> <p>Web User Interface: Settings->Call Display->Display Called Party Information</p> <p>Phone User Interface: None</p>		
<code>phone_setting.call_info_display_method</code>	0, 1, 2, 3 or 4	0
<p>Description: Specifies the call information display method when the IP phone receives an incoming call, dials an outgoing call or is during an active call.</p> <p>0-Name+Number 1-Number+Name 2-Name 3-Number 4-Full Contact Info (display name< sip:xxx@domain.com>)</p> <p>Web User Interface:</p>		

Parameters	Permitted Values	Default
Settings->Call Display->Call Information Display Method		
Phone User Interface:		
None		

To configure call display features via web user interface (take SIP-T23G IP phones for example):

1. Click on **Settings->Call Display**.
2. Select the desired value from the pull-down list of **Display Called Party Information**.
3. Select the desired value from the pull-down list of **Call Information Display Method**.

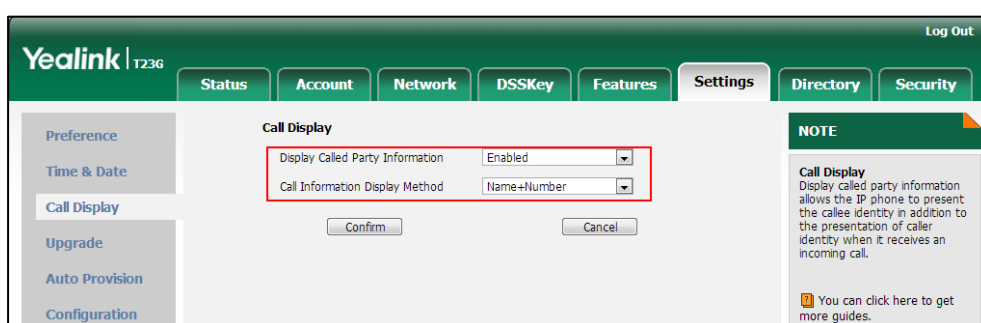

4. Click **Confirm** to accept the change.

To configure call display features via web user interface (take SIP-T46G IP phones for example):

1. Click on **Settings->Call Display**.
2. Select the desired value from the pull-down list of **Display Contact Photo**.
3. Select the desired value from the pull-down list of **Display Called Party Information**.
4. Select the desired value from the pull-down list of **Call Information Display Method**.

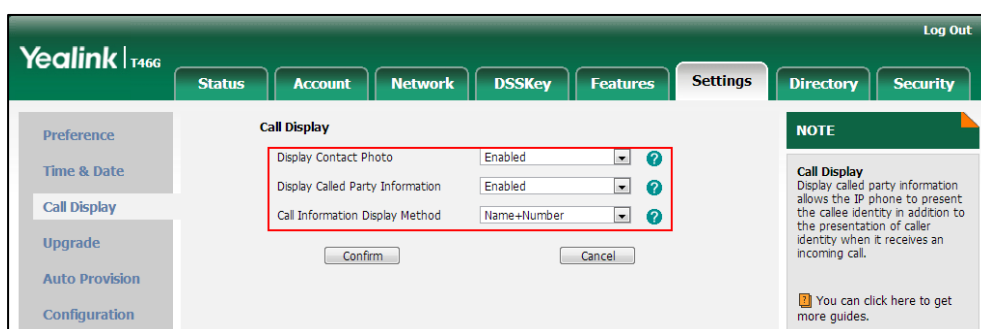

5. Click **Confirm** to accept the change.

Display Method on Dialing

When the IP phone is on the pre-dialing or dialing screen, the account information will

be displayed on the top left corner of the LCD screen. You can customize the account information to be displayed on the IP phone as required. IP phones support three account information display methods: Label, Display Name and User Name.

Procedure

Display method on dialing can be configured using the configuration files or locally.

Configuration File	<y0000000000xx>.cfg	Configure display method on dialing. Parameter: features.caller_name_type_on_dialing
Local	Web User Interface	Configure display method on dialing. Navigate to: http://<phoneIPAddress>/servlet?p=features-general&q=load

Details of Configuration Parameters:

Parameter	Permitted Values	Default
features.caller_name_type_on_dialing	1, 2 or 3	3
<p>Description:</p> <p>Configures the account information displayed on the top left corner of the LCD screen when the IP phone is on the pre-dialing or dialing screen.</p> <p>1-Label 2-Display Name 3-User Name</p> <p>Web User Interface: Features->General Information->Display Method on Dialing</p> <p>Phone User Interface: None</p>		

To configure display method on dialing via web user interface:

1. Click on **Features->General Information**.

2. Select the desired value from the pull-down list of **Display Method on Dialing** field.

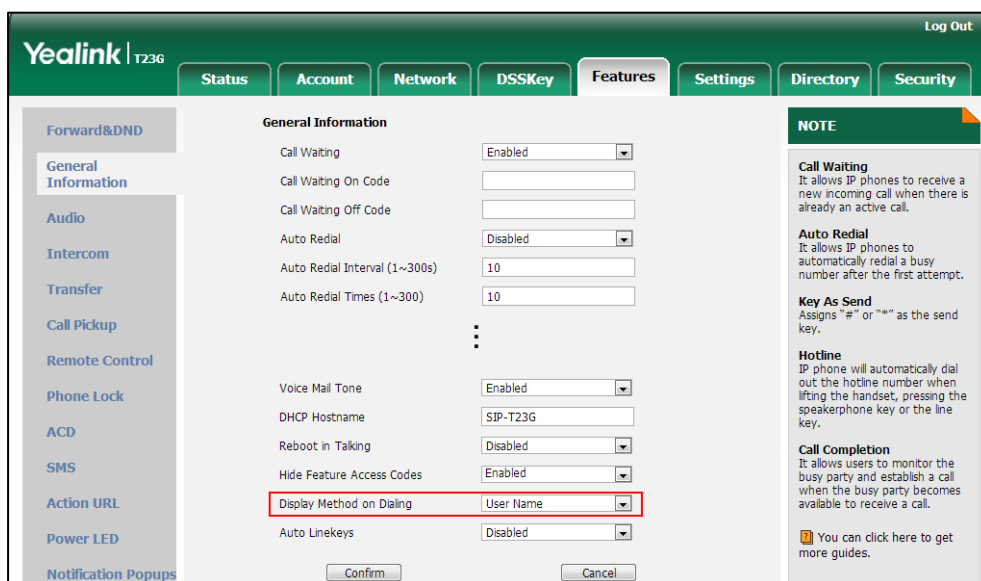

3. Click **Confirm** to accept the change.

Web Server Type

Web server type determines access protocol of the IP phone’s web user interface. IP phones support both HTTP and HTTPS protocols for accessing the web user interface. HTTP is an application protocol that runs on top of the TCP/IP suite of protocols. HTTPS is a web protocol that encrypts and decrypts user page requests as well as pages returned by the web server. Both HTTP and HTTPS port numbers are configurable.

Procedure

Web server type can be configured using the configuration files or locally.

Configuration File	<y0000000000xx>.cfg	Configure the web access type, HTTP port and HTTPS port. Parameters: wui.http_enable network.port.http wui.https_enable network.port.https
	Local	Configure the web access type, HTTP port and HTTPS port. Navigate to: http://<phoneIPAddress>/servlet?p=network-adv&q=load
	Phone User Interface	Configure the web access type,

		HTTP port and HTTPS port.
--	--	---------------------------

Details of Configuration Parameters:

Parameters	Permitted Values	Default
wui.http_enable	0 or 1	1
<p>Description: Enables or disables the user to access web user interface of the IP phone using the HTTP protocol.</p> <p>0-Disabled 1-Enabled</p> <p>Note: If you change this parameter, the IP phone will reboot to make the change take effect.</p> <p>Web User Interface: Network->Advanced->Web Server->HTTP</p> <p>Phone User Interface: Menu->Settings->Advanced Settings (default password: admin) ->Network->Webserver Type->HTTP Status</p>		
network.port.http	Integer from 1 to 65535	80
<p>Description: Configures the HTTP port for the user to access web user interface of the IP phone using the HTTP protocol.</p> <p>Note: If you change this parameter, the IP phone will reboot to make the change take effect.</p> <p>Web User Interface: Network->Advanced->Web Server->HTTP Port(1~65535)</p> <p>Phone User Interface: Menu->Settings->Advanced Settings (default password: admin) ->Network->Webserver Type->HTTP Port</p>		
wui.https_enable	0 or 1	1
<p>Description: Enables or disables the user to access web user interface of the IP phone using the HTTPS protocol.</p> <p>0-Disabled 1-Enabled</p>		

Parameters	Permitted Values	Default
<p>Note: If you change this parameter, the IP phone will reboot to make the change take effect.</p> <p>Web User Interface: Network->Advanced->Web Server->HTTPS</p> <p>Phone User Interface: Menu->Settings->Advanced Settings (default password: admin) ->Network->Webserver Type->HTTPS Status</p>		
network.port.https	Integer from 1 to 65535	443
<p>Description: Configures the HTTPS port for the user to access web user interface of the IP phone using the HTTPS protocol.</p> <p>Note: If you change this parameter, the IP phone will reboot to make the change take effect.</p> <p>Web User Interface: Network->Advanced->Web Server->HTTPS Port(1~65535)</p> <p>Phone User Interface: Menu->Settings->Advanced Settings (default password: admin) ->Network->Webserver Type->HTTPS Port</p>		

To configure web server type via web user interface:

1. Click on **Network->Advanced**.
2. Select the desired value from the pull-down list of **HTTP**.
3. Enter the desired HTTP port number in the **HTTP Port(1~65535)** field.
The default HTTP port number is 80.
4. Select the desired value from the pull-down list of **HTTPS**.
5. Enter the desired HTTPS port number in the **HTTPS Port(1~65535)** field.

The default HTTPS port number is 443.

The screenshot shows the Yealink T236 web interface. The 'Network' tab is selected, and the 'Web Server' section is highlighted with a red box. The 'Web Server' section contains the following settings:

Section	Parameter	Value
LLDP	Active	Enabled
	Packet Interval (1-3600s)	60
CDP	Active	Disabled
	Packet Interval (1-3600s)	60
VLAN	WAN Port	Disabled
	VID (1-4094)	1
Web Server	HTTP	Enabled
	HTTP Port (1-65535)	80
	HTTPS	Enabled
	HTTPS Port (1-65535)	443
VPN	Active	Enabled
	Upload VPN Config	Browse... Upload

At the bottom of the page, there are 'Confirm' and 'Cancel' buttons. A 'NOTE' section on the right provides information about VLAN, NAT Traversal, Quality of Service (QoS), Web Server Type, and 802.1X Authentication.

6. Click **Confirm** to accept the change.

A dialog box pops up to prompt that settings will take effect after a reboot.

7. Click **OK** to reboot the phone.

To configure web server type via phone user interface:

1. Press **Menu->Settings->Advanced Settings** (default password: admin) **->Network->Webserver Type**.
2. Press **◀** or **▶**, or the **Switch** soft key to select the desired value from the **HTTP Status** field.
3. Enter the desired HTTP port number in the **HTTP Port** field.
4. Press **◀** or **▶**, or the **Switch** soft key to select the desired value from the **HTTP Status** field.
5. Enter the desired HTTPS port number in the **HTTPS Port** field.
6. Press the **Save** soft key to accept the change.

The IP phone reboots automatically to make settings effective after a period of time.

Time and Date

IP phones maintain a local clock and calendar. Time and date are displayed on the idle screen of IP phones.

The following table lists available configuration methods for time and date.

Option	Configuration Methods
NTP time server	Configuration Files Web User Interface Phone User Interface
Time Zone	Configuration Files Web User Interface Phone User Interface
Time	Web User Interface Phone User Interface
Time Format	Configuration Files Web User Interface Phone User Interface
Date	Web User Interface Phone User Interface
Date Format	Configuration Files Web User Interface Phone User Interface
Daylight Saving Time	Configuration Files Web User Interface

NTP Time Server

A time server is a computer server that reads the actual time from a reference clock and distributes this information to the clients in a network. The Network Time Protocol (NTP) is the most widely used protocol that distributes and synchronizes time in the network.

The IP phones synchronize the time and date automatically from the NTP time server by default. The NTP time server address can be offered by the DHCP server or configured manually. NTP by DHCP Priority feature can configure the priority for the IP phone to use the NTP time server address offered by the DHCP server or configured manually.

Time Zone

A time zone is a region on Earth that has a uniform standard time. It is convenient for areas in close commercial or other communication to keep the same time. When configuring the IP phone to obtain the time and date from the NTP time server, you must set the time zone.

Procedure

NTP time server and time zone can be configured using the configuration files or locally.

<p>Configuration File</p>	<p><MAC>.cfg</p>	<p>Configure NTP by DHCP priority feature and DHCP time feature.</p> <p>Parameters: local_time.manual_ntp_srv_prior local_time.dhcp_time</p> <p>Configure the NTP server, time zone.</p> <p>Parameters: local_time.ntp_server1 local_time.ntp_server2 local_time.interval local_time.time_zone local_time.time_zone_name</p>
<p>Local</p>	<p>Web User Interface</p>	<p>Configure NTP by DHCP priority feature and DHCP time feature.</p> <p>Configure the NTP server, time zone.</p> <p>Navigate to: http://<phoneIPAddress>/servlet?p=settings-datetime&q=load</p>
	<p>Phone User Interface</p>	<p>Configure DHCP time feature.</p> <p>Configure the NTP server, time zone.</p>

Details of Configuration Parameters:

Parameters	Permitted Values	Default
<p>local_time.manual_ntp_srv_prior</p>	<p>0 or 1</p>	<p>0</p>
<p>Description: Configures the priority for the IP phone to use the NTP server address offered by the DHCP server.</p> <p>0-High (use the NTP server address offered by the DHCP server preferentially) 1-Low (use the NTP server address configured manually preferentially)</p> <p>Web User Interface:</p>		

Parameters	Permitted Values	Default
Settings->Time & Date->NTP by DHCP Priority Phone User Interface: None		
local_time.dhcp_time	0 or 1	0
Description: Enables or disables the IP phone to update time with the offset time offered by the DHCP server. 0 -Disabled 1 -Enabled Note: It is only available to offset from GMT 0. Web User Interface: Settings->Time & Date->DHCP Time Phone User Interface: Menu->Settings->Basic Settings->Time & Date->DHCP Time		
local_time.ntp_server1	IP Address or Domain Name	cn.pool.ntp.org
Description: Configures the IP address or the domain name of the NTP server 1. Example: local_time.ntp_server1 = 192.168.0.5 Web User Interface: Settings->Time & Date->Primary Server Phone User Interface: Menu->Settings->Basic Settings->Time & Date->SNTP Settings->NTP Server1		
local_time.ntp_server2	IP Address or Domain Name	cn.pool.ntp.org
Description: Configures the IP address or the domain name of the NTP server 2. If the NTP server 1 is not configured or cannot be accessed, the IP phone will request the time and date from the NTP server 2. Example: local_time.ntp_server2 = 192.168.0.6 Web User Interface:		

Parameters	Permitted Values	Default
Settings->Time & Date->Secondary Server Phone User Interface: Menu->Settings->Basic Settings->Time & Date->SNTP Settings->NTP Server2		
local_time.interval	Integer from 15 to 86400	1000
<p>Description: Configures the interval (in seconds) to update time and date from the NTP server.</p> <p>Example: local_time.interval = 1000</p> <p>Web User Interface: Settings->Time & Date->Synchronism (15~86400s)</p> <p>Phone User Interface: None</p>		
local_time.time_zone	-11 to +14	+8
<p>Description: Configures the time zone. For more available time zones, refer to Appendix B: Time Zones on page 749.</p> <p>Example: local_time.time_zone = +8</p> <p>Web User Interface: Settings->Time & Date->Time Zone</p> <p>Phone User Interface: Menu->Settings->Basic Settings->Time & Date->SNTP Settings->Time Zone</p>		
local_time.time_zone_name	String within 32 characters	China(Beijing)
<p>Description: Configures the time zone name. The available time zone names depend on the time zone configured by the parameter "local_time.time_zone". For more information on the available time zone names for each time zone, refer to Appendix B: Time Zones on page 749.</p> <p>Example: local_time.time_zone_name = China(Beijing)</p> <p>Note: It works only if the value of the parameter "local_time.summer_time" is set to 2 (Automatic) and the parameter "local_time.time_zone" should be configured in</p>		

Parameters	Permitted Values	Default
advance. Web User Interface: Settings->Time & Date->Location Phone User Interface: Menu->Settings->Basic Settings->Time & Date->SNTP Settings->Location		

To configure NTP by DHCP priority feature via web user interface:

1. Click on **Settings->Time & Date**.
2. Select the desired value from the pull-down list of **NTP by DHCP Priority**.

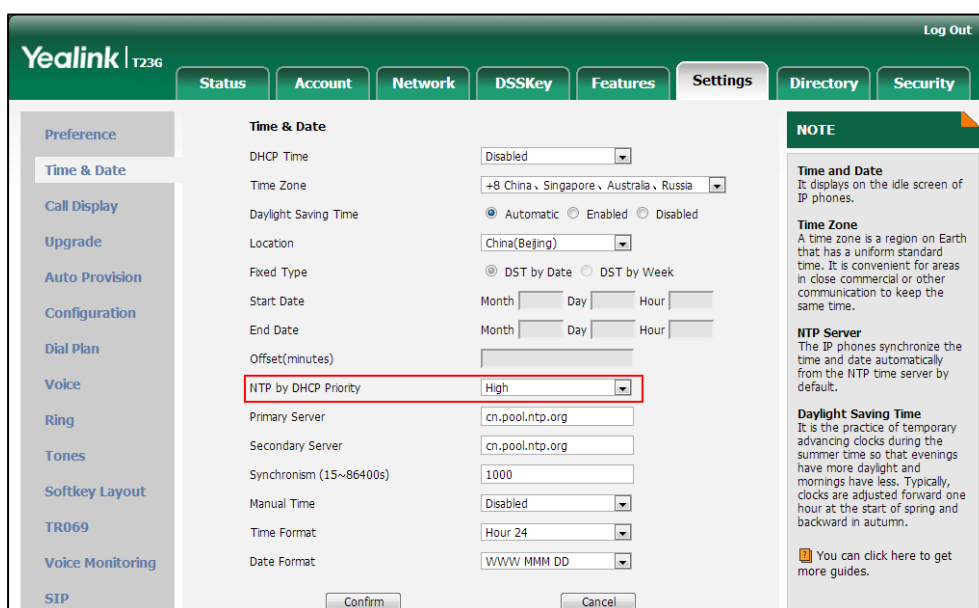

3. Click **Confirm** to accept the change.

To configure the NTP server, time zone via web user interface:

1. Click on **Settings->Time & Date**.
2. Select **Disabled** from the pull-down list of **Manual Time**.
3. Select the desired time zone from the pull-down list of **Time Zone**.
4. Select the desired location from the pull-down list of **Location**.
5. Enter the domain names or IP addresses in the **Primary Server** and **Secondary Server** fields respectively.

- Enter the desired time interval in the **Synchronism (15~86400s)** field.

The screenshot shows the 'Time & Date' configuration page in the Yealink 1236 web interface. The 'Synchronism (15~86400s)' field is highlighted with a red box and contains the value '1000'. Other fields include DHCP Time (Disabled), Time Zone (+8 China, Singapore, Australia, Russia), Daylight Saving Time (Automatic), Location (China(Beijing)), Fixed Type (DST by Date), Start Date, End Date, Offset (minutes), NTP by DHCP Priority (High), Primary Server (cn.pool.ntp.org), Secondary Server (cn.pool.ntp.org), Manual Time (Disabled), Time Format (Hour 24), and Date Format (WWW MMM DD). A 'NOTE' section on the right provides information about Time and Date, Time Zone, NTP Server, and Daylight Saving Time.

- Click **Confirm** to accept the change.

To configure the NTP server and time zone via phone user interface:

- Press **Menu->Settings->Basic Settings->Time & Date->SNTP Settings**.
- Press **◀** or **▶**, or the **Switch** soft key to select the time zone that applies to your area from the **Time Zone** field.

The default time zone is "+8".

- Enter the domain names or IP addresses in the **NTP Server1** and **NTP Server2** fields respectively.
- Press **◀** or **▶**, or the **Switch** soft key to select the desired value from the **Daylight Saving** field.

If **Automatic** is selected, the **Location** field will appear.

- Press **◀** or **▶**, or the **Switch** soft key to select the desired value from the **Location** field.
- Press the **Save** soft key to accept the change.

Time and Date Settings

You can set the time and date manually when IP phones cannot obtain the time and date from the NTP time server. The time and date display can use one of several different formats.

Procedure

Time and date can be configured using the configuration files or locally.

<p>Configuration File</p>	<p><MAC>.cfg</p>	<p>Configure the time and date manually.</p> <p>Parameter:</p> <p>local_time.manual_time_enable</p> <p>Configure the time and date formats.</p> <p>Parameters:</p> <p>local_time.time_format</p> <p>local_time.date_format</p>
<p>Local</p>	<p>Web User Interface</p>	<p>Configure the time and date manually.</p> <p>Configure the time and date formats.</p> <p>Navigate to:</p> <p>http://<phoneIPAddress>/servlet?p=settings-datetime&q=load</p>
	<p>Phone User Interface</p>	<p>Configure the time and date manually.</p> <p>Configure the time and date formats.</p>

Details of Configuration Parameters:

Parameters	Permitted Values	Default
<p>local_time.manual_time_enable</p>	<p>0 or 1</p>	<p>0</p>
<p>Description:</p> <p>Enables or disables the IP phone to obtain time and date from manual settings.</p> <p>0-Disabled (obtain time and date from NTP server)</p> <p>1-Enabled (obtain time and date from manual settings)</p> <p>Web User Interface:</p> <p>Settings->Time & Date->Manual Time</p> <p>Phone User Interface:</p> <p>None</p>		

Parameters	Permitted Values	Default
local_time.time_format	0 or 1	1
<p>Description: Configures the time format.</p> <p>0-Hour 12 1-Hour 24</p> <p>If it is set to 0 (Hour 12), the time will be displayed in 12-hour format with AM or PM specified.</p> <p>If it is set to 1 (Hour 24), the time will be displayed in 24-hour format (e.g., 2:00 PM displays as 14:00).</p> <p>Web User Interface: Settings->Time & Date->Time Format</p> <p>Phone User Interface: Menu->Settings->Basic Settings->Time & Date->Time & Date Format->Time Format</p>		
local_time.date_format	0, 1, 2, 3, 4, 5 or 6	0
<p>Description: Configures the date format.</p> <p>Valid values are:</p> <p>0-WWW MMM DD 1-DD-MMM-YY 2-YYYY-MM-DD 3-DD/MM/YYYY 4-MM/DD/YY 5-DD MMM YYYY 6-WWW DD MMM</p> <p>Note: "WWW" represents the abbreviation of the week, "DD" represents a two-digit day, "MMM" represents the first three letters of the month, "YYYY" represents a four-digit year, and "YY" represents a two-digit year.</p> <p>Web User Interface: Settings->Time & Date->Date Format</p> <p>Phone User Interface: Menu->Settings->Basic Settings->Time & Date->Time & Date Format->Date Format</p>		

To configure the time and date manually via web user interface:

1. Click on **Settings->Time & Date**.

2. Select **Enabled** from the pull-down list of **Manual Time**.
3. Enter the time and date in the corresponding fields.

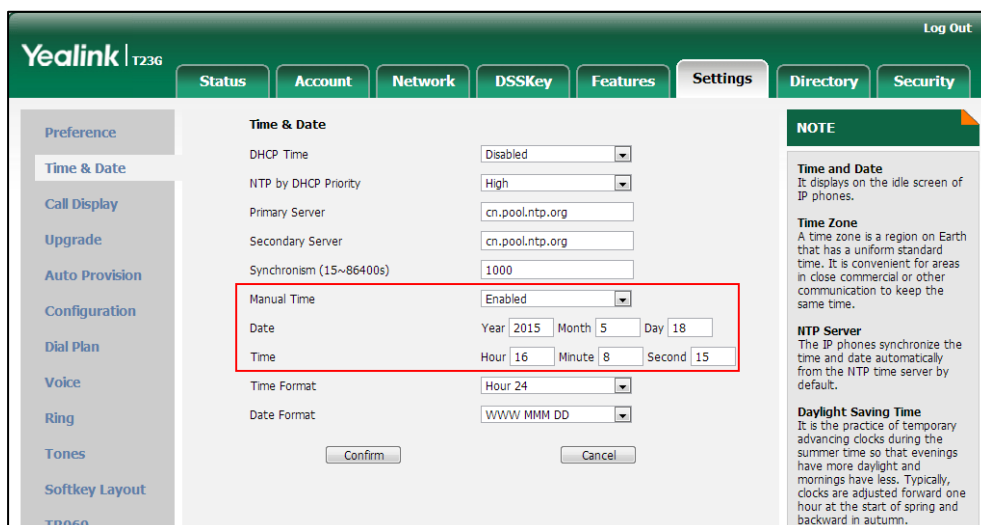

4. Click **Confirm** to accept the change.

To configure the time and date format via web user interface:

1. Click on **Settings->Time & Date**.
2. Select the desired value from the pull-down list of **Time Format**.
3. Select the desired value from the pull-down list of **Date Format**.

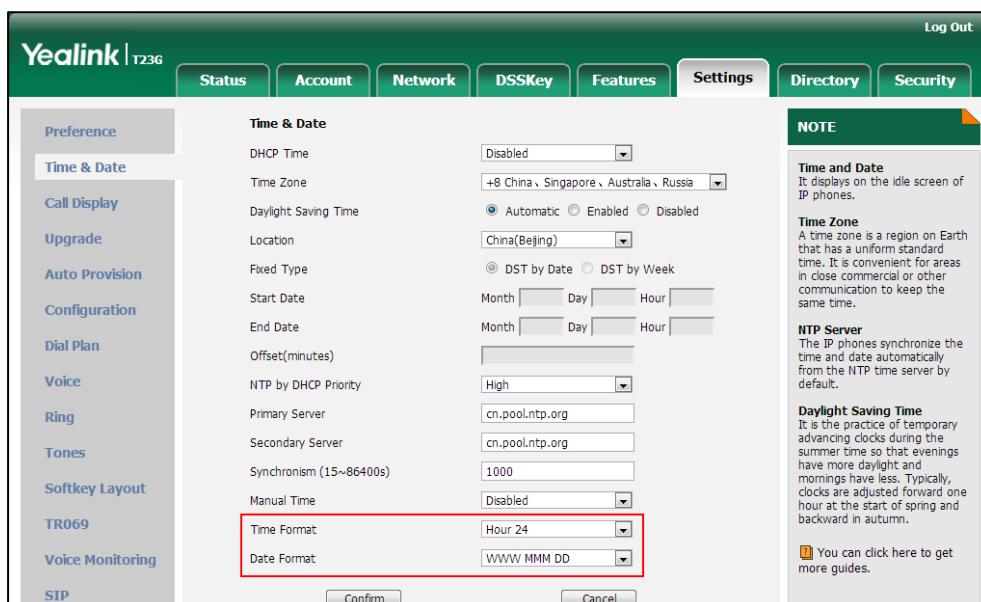

4. Click **Confirm** to accept the change.

To configure the time and date manually via phone user interface:

1. Press **Menu->Settings->Basic Settings->Time & Date->Manual Settings**.
2. Enter the date in the **Date(YMD)** field.

3. Enter the time in the **Time(HMS)** field.
4. Press the **Save** soft key to accept the change.

To configure the time and date formats via phone user interface:

1. Press **Menu->Settings->Basic Settings->Time & Date->Time & Date Format**.
2. Press ◀ or ▶, or the **Switch** soft key to select the desired time format from the **Time Format** field.
3. Press ◀ or ▶, or the **Switch** soft key to select the desired date format from the **Date Format** field.
4. Press the **Save** soft key to accept the change.

Daylight Saving Time

Daylight Saving Time (DST) is the practice of temporary advancing clocks during the summer time so that evenings have more daylight and mornings have less. Typically, clocks are adjusted forward one hour at the start of spring and backward in autumn. Many countries have used the DST at various times, details vary by location. By default, the DST is set to Automatic, so it can be adjusted automatically from the current time zone configuration. You can configure DST for the desired area as required.

Procedure

Daylight saving time can be configured using the configuration files or locally.

Configuration File	<MAC>.cfg	Configure DST. Parameters: local_time.summer_time local_time.dst_time_type local_time.start_time local_time.end_time local_time.offset_time
Local	Web User Interface	Configure DST. Navigate to: <a href="http://<phoneIPAddress>/servlet?p=settings-datetime&q=load">http://<phoneIPAddress>/servlet?p=settings-datetime&q=load

Details of Configuration Parameters:

Parameters	Permitted Values	Default
local_time.summer_time	0, 1 or 2	2

Parameters	Permitted Values	Default
<p>Description: Configures Daylight Saving Time (DST) feature.</p> <p>0-Disabled 1-Enabled 2-Automatic</p> <p>Web User Interface: Settings->Time & Date->Daylight Saving Time</p> <p>Phone User Interface: Menu->Settings->Basic Settings->Time & Date->SNTP Settings->Daylight Saving</p>		
local_time.dst_time_type	0 or 1	0
<p>Description: Configures the DST time type.</p> <p>0-DST by Date 1-DST by Week</p> <p>Note: It works only if the value of the parameter "local_time.summer_time" is set to 1 (Enabled).</p> <p>Web User Interface: Settings->Time & Date->Fixed Type</p> <p>Phone User Interface: None</p>		
local_time.start_time	Time	1/1/0
<p>Description: Configures the start time of the DST.</p> <p>Value formats are:</p> <ul style="list-style-type: none"> Month/Day/Hour (for DST by Date) Month/Week of Month/Day of Week/Hour of Day (for DST by Week) <p>If "local_time.dst_time_type" is set to 0 (DST by Date), use the mapping:</p> <p>Month: 1=January, 2=February,..., 12=December</p> <p>Day: 1=the first day in a month,..., 31= the last day in a month</p> <p>Hour: 0=0am, 1=1am,..., 23=11pm</p> <p>If "local_time.dst_time_type" is set to 1 (DST by Week), use the mapping:</p> <p>Month: 1=January, 2=February,..., 12=December</p>		

Parameters	Permitted Values	Default
<p>Week of Month: 1=the first week in a month,..., 5=the last week in a month</p> <p>Day of Week: 1=Monday, 2=Tuesday,..., 7=Sunday</p> <p>Hour of Day: 0=0am, 1=1am,..., 23=11pm</p> <p>Note: It works only if the value of the parameter "local_time.summer_time" is set to 1 (Enabled).</p> <p>Web User Interface: Settings->Time & Date->Start Date</p> <p>Phone User Interface: None</p>		
local_time.end_time	Time	12/31/23
<p>Description: Configures the end time of the DST.</p> <p>Value formats are:</p> <ul style="list-style-type: none"> • Month/Day/Hour (for DST by Date) • Month/Week of Month/Day of Week/Hour of Day (for DST by Week) <p>If "local_time.dst_time_type" is set to 0 (DST by Date), use the mapping:</p> <p>Month: 1=January, 2=February,..., 12=December</p> <p>Day: 1=the first day in a month,..., 31= the last day in a month</p> <p>Hour: 0=0am, 1=1am,..., 23=11pm</p> <p>If "local_time.dst_time_type" is set to 1 (DST by Week), use the mapping:</p> <p>Month: 1=January, 2=February,..., 12=December</p> <p>Week of Month: 1=the first week in a month,..., 5=the last week in a month</p> <p>Day of Week: 1=Monday, 2=Tuesday,..., 7=Sunday</p> <p>Hour of Day: 0=0am, 1=1am,..., 23=11pm</p> <p>Note: It works only if the value of the parameter "local_time.summer_time" is set to 1 (Enabled).</p> <p>Web User Interface: Settings->Time & Date->End Date</p> <p>Phone User Interface: None</p>		
local_time.offset_time	Integer from -300 to 300	Blank
<p>Description: Configures the offset time (in minutes) of DST.</p>		

Parameters	Permitted Values	Default
<p>Note: It works only if the value of the parameter "local_time.summer_time" is set to 1 (Enabled).</p> <p>Web User Interface: Settings->Time & Date->Offset(minutes)</p> <p>Phone User Interface: None</p>		

To configure the DST via web user interface:

1. Click on **Settings->Time & Date**.
2. Select **Disabled** from the pull-down list of **Manual Time**.
3. Select the desired time zone from the pull-down list of **Time Zone**.
4. Enter the domain names or IP addresses in the **Primary Server** and **Secondary Server** fields respectively.
5. Enter the desired time interval in the **Synchronism (15~86400s)** field.
6. Mark the **Enabled** radio box in the **Daylight Saving Time** field.
 - Mark the **DST by Date** radio box in the **Fixed Type** field.
 - Enter the start time in the **Start Date** field.
 - Enter the end time in the **End Date** field.

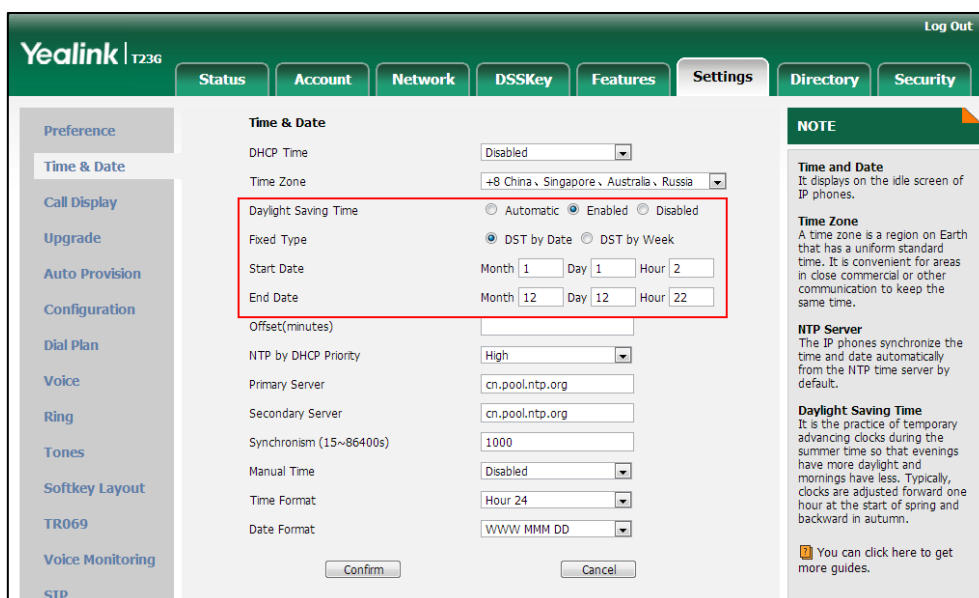

- Mark the **DST by Week** radio box in the **Fixed Type** field.

Select the desired values of DST Start Month, DST Start Week of Month, DST Start Day of Week, Start Hour of Day; DST Stop Month, DST Stop Week of Month, DST Stop Day of Week and End Hour of Day from the pull-down lists.

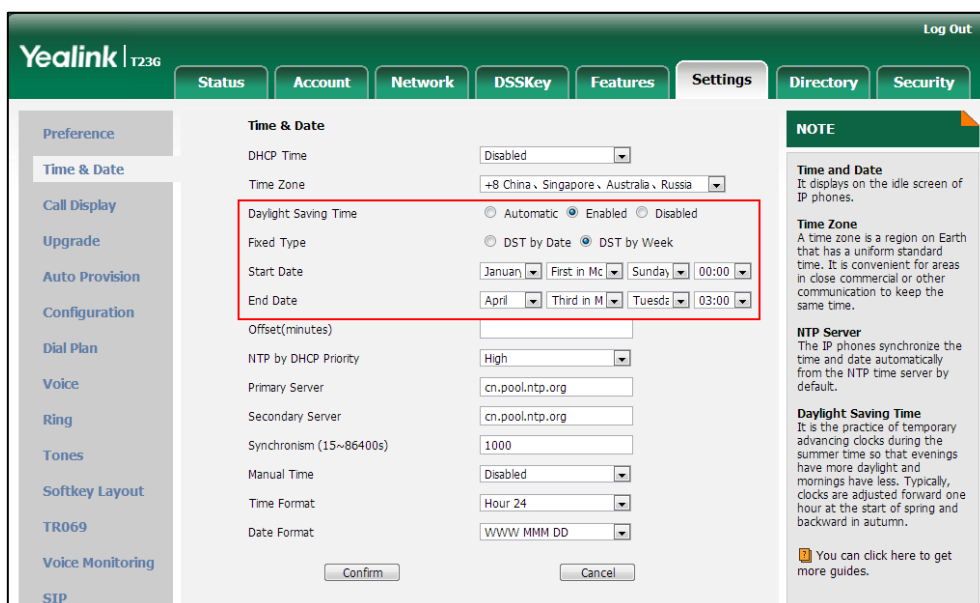

7. Enter the desired offset time in the **Offset(minutes)** field.
8. Click **Confirm** to accept the change.

Customizing an AutoDST Template File

The time zone and corresponding DST pre-configurations exist in the AutoDST file. If the DST is set to Automatic, the IP phone obtains the DST configuration from the AutoDST file. You can customize the AutoDST file if required. The AutoDST file allows you to add or modify time zone and DST settings for your area each year.

Before customizing, you need to obtain the AutoDST file. You can ask the distributor or Yealink FAE for DST template. You can also obtain the DST template online:

<http://support.yealink.com/documentFront/forwardToDocumentFrontDisplayPage>. For more information on obtaining the template file, refer to [Obtaining Configuration Files and Resource Files](#) on page 42.

The following table lists description of each element in the template file:

Element	Type	Values	Description
DSTData	required	no	File root element
DST	required	no	Time Zone item's root element
szTime	required	[+/-][X]:[Y], X=0~14, Y=0~59	Time Zone
szZone	required	String (if the content is more than one city, it is the best to	Time Zone name

Element	Type	Values	Description
		keep their daylight saving time the same)	
iType	optional	0/1 0: DST by Date 1: DST by Week	DST time type (This item is needed if you want to configure DST.)
szStart	optional	Month/Day/Hour (for iType=0) Month: 1~12 Day: 1~31 Hour: 0 (midnight)~23 Month/Week of Month/Day of Week/Hour of Day (for iType=1) Month: 1~12 Week of Month: 1~5 (the last week) Day of Week: 1~7 Hour of Day: 0 (midnight)~23	Start time of the DST
szEnd	optional	Same as szStart	End time of the DST
szOffset	optional	Integer from -300 to 300	The offset time (in minutes) of DST

When customizing an AutoDST file, learn the following:

- <DSTData> indicates the start of a template and </DSTData> indicates the end of a template.
- Add or modify time zone and DST settings between <DSTData> and </DSTData>.
- The display order of time zone is corresponding to the szTime order specified in the AutoDST.xml file.
- If the start time of DST is greater than the end time, the valid time of DST is from the start time of this year to the end time of the next year.

Customizing an AutoDST file:

1. Open the AutoDST file using an ASCII editor.
2. Add or modify time zone and DST settings as you want in the AutoDST file.

Example 1:

To modify the DST settings for the existing time zone “+5 Pakistan(Islamabad)” and add DST settings for the existing time zone “+5:30 India(Calcutta)”.

```

AutoDST.xml x
0 10 20 30 40 50 60 70 80 90 100 110
<DST szTime="+3:30" szZone="Iran (Teheran)" iType="0" szStart="3/22/0" szEnd="9/22/0" szOffset="60"/>
<DST szTime="+4" szZone="Armenia (Yerevan)" iType="1" szStart="3/5/7/2" szEnd="10/5/7/3" szOffset="60"/>
<DST szTime="+4" szZone="Azerbaijan (Baku)" iType="1" szStart="3/5/7/4" szEnd="10/5/7/5" szOffset="60"/>
<DST szTime="+4" szZone="Georgia (Tbilisi)" />
<DST szTime="+4" szZone="Kazakhstan (Aktau)" />
<DST szTime="+4" szZone="Russia (Samara)" />
<DST szTime="+4:30" szZone="Afghanistan (Kabul)" />
<DST szTime="+5" szZone="Kazakhstan (Aqtobe)" />
<DST szTime="+5" szZone="Kyrgyzstan (Bishkek)" />
<DST szTime="+5" szZone="Pakistan (Islamabad)" iType="0" szStart="4/15/0" szEnd="11/1/0" szOffset="60"/>
<DST szTime="+5" szZone="Russia (Chelyabinsk)" />
<DST szTime="+5:30" szZone="India (Calcutta)" iType="1" szStart="9/5/7/3" szEnd="4/1/7/2" szOffset="60"/>
<DST szTime="+5:45" szZone="Nepal (Katmandu)" />
<DST szTime="+6" szZone="Kazakhstan (Astana, Almaty)" />
<DST szTime="+6" szZone="Russia (Novosibirsk, Omsk)" />
<DST szTime="+6:30" szZone="Myanmar (Naypyitaw)" />
<DST szTime="+7" szZone="Russia (Krasnoyarsk)" />
<DST szTime="+7" szZone="Thailand (Bangkok)" />
<DST szTime="+8" szZone="China (Beijing)" />
<DST szTime="+8" szZone="Singapore (Singapore)" />
    
```

Example 2:

Add a new time zone (+6 Paradise) with daylight saving time 30 minutes.

```

AutoDST.xml x
10 20 30 40 50 60 70 80 90
<DST szTime="+4:30" szZone="Afghanistan (Kabul)" />
<DST szTime="+5" szZone="Kazakhstan (Aqtobe)" />
<DST szTime="+5" szZone="Kyrgyzstan (Bishkek)" />
<DST szTime="+5" szZone="Pakistan (Islamabad)" iType="0" szStart="4/15/0" szEnd="11/1/0" />
<DST szTime="+5" szZone="Russia (Chelyabinsk)" />
<DST szTime="+5:30" szZone="India (Calcutta)" />
<DST szTime="+5:45" szZone="Nepal (Katmandu)" />
<DST szTime="+6" szZone="Paradise" iType="1" szStart="3/5/7/2" szEnd="10/5/7/3" szOffset="30"/>
<DST szTime="+6" szZone="Kazakhstan (Astana, Almaty)" />
<DST szTime="+6" szZone="Russia (Novosibirsk, Omsk)" />
<DST szTime="+6:30" szZone="Myanmar (Naypyitaw)" />
<DST szTime="+7" szZone="Kazakhstan (Astana, Almaty)" />
<DST szTime="+7" szZone="Russia (Krasnoyarsk)" />
<DST szTime="+7" szZone="Thailand (Bangkok)" />
<DST szTime="+8" szZone="China (Beijing)" />
<DST szTime="+8" szZone="Singapore (Singapore)" />
<DST szTime="+8" szZone="Australia (Perth)" iType="1" szStart="10/1/7/2" szEnd="3/5/7/3" />
<DST szTime="+8" szZone="Russia (Irkutsk, Ulan-Ude)" />
<DST szTime="+8:45" szZone="Eucla" />
<DST szTime="+9" szZone="Korea (Seoul)" />
<DST szTime="+9" szZone="Japan (Tokyo)" />
<DST szTime="+9" szZone="Russia (Yakutsk, Chita)" />
<DST szTime="+9:30" szZone="Australia (Adelaide)" iType="1" szStart="10/1/7/2" szEnd="4/1/7/3" />
<DST szTime="+9:30" szZone="Australia (Darwin)" />
<DST szTime="+10" szZone="Australia (Sydney, Melbourne, Canberra)" iType="1" szStart="10/1/7/2" />
<DST szTime="+10" szZone="Australia (Brisbane)" />
    
```

3. Save this file and place it to the provisioning server (e.g., 192.168.1.100).
4. Specify the access URL of the AutoDST file in the configuration files.

Procedure

The access URL of the AutoDST file can be specified using the configuration files.

Configuration File	<MAC>.cfg	Specify the access URL of the AutoDST file. Parameters: auto_dst.url
---------------------------	-----------	---

Details of Configuration Parameters:

Parameters	Permitted Values	Default
auto_dst.url	URL within 511 characters	Blank
<p>Description: Configures the access URL of the AutoDST file (AutoDST.xml).</p> <p>Example: auto_dst.url = tftp://192.168.1.100/AutoDST.xml</p> <p>During the auto provisioning process, the IP phone connects to the provisioning server "192.168.1.100", and downloads the AutoDST file "AutoDST.xml". After update, you will find a new time zone "Paradise" and updated DST of "Pakistan(Islamabad)" and "India(Calcutta)" via web user interface: Settings->Time & Date->Time Zone.</p> <p>Note: It works only if the value of the parameter "local_time.summer_time" is set to 2 (Automatic).</p> <p>Web User Interface: None</p> <p>Phone User Interface: None</p>		

Language

IP phones support multiple languages. Languages used on the phone user interface and web user interface can be specified respectively as required.

The following table lists languages supported by the phone user interface and the web user interface.

Phone/Web User Interface
English
Chinese Simplified
Chinese Traditional
French
German
Italian
Polish
Portuguese
Spanish

Phone/Web User Interface
Turkish
Russian

Loading Language Packs

Languages available for selection depend on language packs currently loaded to the IP phone. You can customize the translation of the existing language on the phone user interface or web user interface. You can also make new languages (not included in the available language list) available for use on the phone user interface and web user interface by loading language packs to the IP phone. Language packs can only be loaded using configuration files.

You can ask the distributor or Yealink FAE for language packs. You can also obtain the language packs online:

<http://support.yealink.com/documentFront/forwardToDocumentFrontDisplayPage>. For more information on obtaining the language packs, refer to [Obtaining Configuration Files and Resource Files](#) on page 42.

Note

To modify translation of an existing language, do not rename the language file.

The new added language must be supported by the font library on the IP phone. If the characters in the custom language file are not supported by the phone, the IP phone will display “?” instead.

Customizing a Language for Phone User Interface

The following table lists the available languages and associated language packs for the phone user interface:

Available Language	Associated Language Pack
English	000.GUI.English.lang
Chinese Simplified	001.GUI.Chinese_S.lang
Chinese Traditional	002.GUI.Chinese_T.lang
French	003.GUI.French.lang
German	004.GUI.German.lang
Italian	005.GUI.Italian.lang
Polish	006.GUI.Polish.lang
Portuguese	007.GUI.Portuguese.lang
Spanish	008.GUI.Spanish.lang

Available Language	Associated Language Pack
Turkish	009.GUI.Turkish.lang
Russian	010.GUI.Russian.lang

When adding a new language pack for the phone user interface, the language pack must be formatted as "X.GUI.name.lang" (X starts from 011, "name" is replaced with the language name). If the language name is the same as the existing one, the existing language pack will be overridden by the new uploaded one. We recommend that the filename of the new language pack should not be the same as the existing one.

To customize a language file:

1. Open the desired language template file (e.g., 000.GUI.English.lang) using an ASCII editor.
2. Modify the characters within the double quotation marks on the right of the equal sign. Don't modify the translation item on the left of the equal sign.

The following shows a portion of the language pack "000.GUI.English.lang" for the phone user interface (take SIP-T23G IP phones for example):

```

000.GUI.English.lang x
1 [ Lang ]
2
3 " Conference " = " Conference "
4 "*" or "#" as send = "Key as send"
5 "(Empty)" = "(Empty)"
6 "12 Hour" = "12 Hour"
7 "120s" = "120s"
8 "15s" = "15s"
9 "1800s" = "1800s"
10 "24 Hour" = "24 Hour"
11 "300s" = "300s"
12 "30s" = "30s"
13 "600s" = "600s"
14 "60s" = "60s"
15 "802.1x Mode" = "802.1x Mode"
16 "802.1x Settings" = "802.1x Settings"
17 "ACD Login" = "ACD Login"
18 "ACD State" = "ACD State"
19 "ACD Status" = "ACD Status"
20 "ACD Trace" = "Trace"
21 "ACD" = "ACD"
22 "ALERT" = "ALERT"
23 "AM" = "AM"

```

3. Save the language file and place it to the provisioning server (e.g., 192.168.10.25).
4. Specify the access URL of the phone user interface language pack in the configuration files.

If you want to add a new custom language (e.g., Guilan) to your IP phone (e.g., SIP-T23G), prepare the language file named as "011.GUI.Guilan.lang" for downloading. After update, you will find a new language selection "Guilan" on the IP phone user

interface: **Menu->Settings->Basic Settings->Language.**

Procedure

Loading language pack can only be performed using the configuration files.

<p>Configuration File</p>	<p><y0000000000xx>.cfg</p>	<p>Specify the access URL of the phone user interface language pack.</p> <p>Parameter: gui_lang.url</p> <p>Delete custom LCD language packs of the phone user interface.</p> <p>Parameter: gui_lang.delete</p>
----------------------------------	----------------------------------	--

Details of the Configuration Parameter:

Parameter	Permitted Values	Default
gui_lang.url	URL within 511 characters	Blank
<p>Description: Configures the access URL of the custom LCD language pack for the phone user interface.</p> <p>Example: gui_lang.url = http://192.168.10.25/000.GUI.English.lang</p> <p>During the auto provisioning process, the IP phone connects to the HTTP provisioning server "192.168.10.25", and downloads the language pack "000.GUI.English.lang". The English language translation will be changed accordingly if you have modified the language template file.</p> <p>If you want to download multiple language packs to the phone simultaneously, you can configure as following: gui_lang.url = http://192.168.10.25/000.GUI.English.lang gui_lang.url = http://192.168.10.25/001.GUI.Chinese_S.lang</p> <p>Web User Interface: None</p> <p>Phone User Interface: None</p>		
gui_lang.delete	http://localhost/all or http://localhost/Y.GUI.nam	Blank

Parameter	Permitted Values	Default
	<i>e.lang</i>	
<p>Description: Deletes the specified or all custom LCD language packs of the phone user interface.</p> <p>Example: Delete all custom language packs of the phone user interface: gui_lang.delete = http://localhost/all</p> <p>Delete a custom language pack of the phone user interface (e.g., 001.GUI.Chinese_S.lang): gui_lang.delete = http://localhost/001.GUI.Chinese_S.lang</p> <p>Web User Interface: None</p> <p>Phone User Interface: None</p>		

Customizing a Language for Web User Interface

The following table lists available languages and associated language packs for the web user interface:

Available Language	Associated Language Pack	Associated Note Language Pack
English	1.English.js	1.English_note.xml
Chinese Simplified	2.Chinese_S.js	2.Chinese_S_note.xml
Chinese Traditional	3.Chinese_T.js	3.Chinese_T_note.xml
French	4.French.js	4.French_note.xml
German	5.German.js	5.German_note.xml
Italian	6.Italian.js	6.Italian_note.xml
Polish	7.Polish.js	7.Polish_note.xml
Portuguese	8.Portuguese.js	8.Portuguese_note.xml
Spanish	9.Spanish.js	9.Spanish_note.xml
Turkish	10.Turkish.js	10.Turkish_note.xml
Russian	11.Russian.js	11.Russian_note.xml

When adding a new language pack for the web user interface, the language pack must be formatted as “Y.name.js” (Y starts from 12, “name” is replaced with the language name). If the language name is the same as the existing one, the existing language file will be overridden by the new uploaded one. We recommend that the name of the new language file should not be the same as the existing languages.

To customize a language file:

1. Open the desired language template file (e.g., 1.English.js) using an ASCII editor.
2. Modify the characters within the double quotation marks on the right of the colon. Don't modify the translation item on the left of the colon.

The following shows a portion of the language pack “1.English.js” for the web user interface (take SIP-T23G IP phones for example):

```

1  var _objTrans =
2  {
3
4  " Call Number Filter":"Call Number Filter",
5  " Distinctive Ring Tones":"Distinctive Ring Tones",
6  " Do you want to reboot ?":"Do you want to reboot?",
7  "(800*480)":"(800*480)",
8  "0":"0",
9  "1":"1",
10 "10min":"10min",
11 "1min":"1min",
12 "2":"2",
13 "2min":"2min",
14 "3":"3",
15 "30min":"30min",
16 "4":"4",
17 "404 (Not found)":"404 (Not Found)",
18 "480 (Temporarily not available)":"480 (Temporarily Not Available)",
19 "486 (Busy here)":"486 (Busy Here)",
20 "5":"5",
21 "5min":"5min",
22 "6":"6",
23 "603 (Decline)":"603 (Decline)",
24 "ACD Auto Available Timer (0~120s)":"ACD Auto Available Timer (0~120s)",
25 "ACD Auto Available":"ACD Auto Available",

```

3. Save the language file and place it to the provisioning server (e.g., 192.168.10.25).
4. Specify the access URL of the web user interface language pack in the configuration files.

You can also customize the translation of the note language pack. The note information is integrated in the icon  of the web user interface. The note language pack must be formatted as “Y.name_note.xml” (“Y” and “name” are associated with web language pack).

To customize a note language file:

1. Open the desired note language template file (e.g., 1.English_note.xml) using an ASCII editor.
2. Modify the text of the note field. Don't modify the name of the note field.

The following shows a portion of the note language pack "1.English_note.xml" for the web user interface (take SIP-T23G IP phones for example):

```

1 <?xml version="1.0" encoding="utf-8"?>
2 <notedata>
3
4 <status>
5   <note name = "version">
6     Displays current firmware version and hardware version of the device
7   </note>
8   <note name = "network">
9     Shows details of the phone network configuration
10  </note>
11  <note name = "network-ipv4">
12    Shows details of the phone network configuration
13  </note>
14  <note name = "network-ipv6">
15    Shows details of the phone network configuration
16  </note>
17  <note name = "network-common">
18    Shows details of the phone network configuration
19  </note>
20  <note name = "AccountStatus">
21    According to current state of each account
22  </note>
23  <note name = "Ext">
24    Shows software version and hardware version details of the Expansion LCD Modules
25  </note>
26 </status>
    
```

3. Save the language file and place it to the provisioning server (e.g., 192.168.10.25).
4. Specify the access URL of the note language pack of the web user interface.

If you want to add a new language (e.g., Wuilan) to IP phones, prepare the language file named as "12.Wuilan.js" and "12.Wuilan_note.xml" for downloading. After update, you will find a new language selection "Wuilan" on the web user interface:

Settings->Preference->Language, and new note information is integrated in the icon when the new language is selected.

Procedure

Loading language pack can only be performed using the configuration files.

Configuration File	<code><y0000000000xx>.cfg</code>	<p>Specify the access URL of the custom language pack for web user interface.</p> <p>Parameter: wui_lang.url</p> <p>Specify the access URL of the custom note language pack for web user interface.</p> <p>Parameter: wui_lang_note.url</p> <p>Delete custom language packs and note language packs of the web user interface.</p> <p>Parameter: wui_lang.delete</p>
---------------------------	--	---

Details of the Configuration Parameter:

Parameter	Permitted Values	Default
wui_lang.url	URL within 511 characters	Blank
<p>Description: Configures the access URL of the custom language pack for the web user interface.</p> <p>Example: wui_lang.url = http://192.168.10.25/1.English.js</p> <p>During the auto provisioning process, the IP phone connects to the HTTP provisioning server "192.168.10.25", and downloads the language pack "1.English.js". The English language translation will be changed accordingly if you have modified the language template file.</p> <p>If you want to download multiple language packs to the web user interface simultaneously, you can configure as following: wui_lang.url = http://192.168.10.25/1.English.js wui_lang.url = http://192.168.10.25/11.Russian.js</p> <p>Web User Interface: None</p> <p>Phone User Interface: None</p>		
wui_lang_note.url	URL within 511 characters	Blank
<p>Description: Configures the access URL of the custom note language pack for web user interface.</p> <p>Example: wui_lang_note.url = http://192.168.10.25/1.English_note.xml</p> <p>During the auto provisioning process, the IP phone connects to the HTTP provisioning server "192.168.10.25", and downloads the note language pack "1.English_note.xml". The English language translation will be changed accordingly if you have modified the language template file.</p> <p>If you want to download multiple language packs to the phone simultaneously, you can configure as following: wui_lang.url = http://192.168.10.25/1.English_note.xml wui_lang.url = http://192.168.10.25/11.Russian_note.xml</p> <p>Web User Interface: None</p> <p>Phone User Interface:</p>		

Parameter	Permitted Values	Default
None		
wui_lang.delete	http://localhost/all or http://localhost/ <i>Y.name.js</i>	Blank
<p>Description: Delete the specified or all custom web language packs and note language packs of the web user interface.</p> <p>Example: Delete all custom language packs of the web user interface: wui_lang.delete = http://localhost/all Delete a custom language pack of the web user interface (e.g., 11.Russian.js): wui_lang.delete = http://localhost/11.Russian.js The corresponding note language pack (e.g., 11.Russian_note.xml) will also be deleted.</p> <p>Web User Interface: None</p> <p>Phone User Interface: None</p>		

Specifying the Language to Use

The default language used on the phone user interface is English. If the language of your web browser is not supported by the IP phone, the web user interface will use English by default. You can specify the languages for the phone user interface and web user interface respectively.

Procedure

Specify the language for the phone user interface or the web user interface using the configuration files or locally.

Configuration File	<y0000000000xx>.cfg	Specify the languages for the phone user interface and the web user interface. Parameters: lang.gui lang.wui
Local	Web User Interface	Specify the language for the web user interface.

		Navigate to: http://<phoneIPAddress>/servlet ?p=settings-preference&q=load
	Phone User Interface	Specify the language for the phone user interface.

Details of Configuration Parameters:

Parameters	Permitted Values	Default
lang.gui	Refer to the following content	English
<p>Description: Configures the language used on the phone user interface.</p> <p>Permitted Values: English, Chinese_S, Chinese_T, French, German, Italian, Polish, Portuguese, Spanish, Turkish, Russian or the custom language name.</p> <p>Example: lang.gui = English If you want to use the custom language (e.g., Guilan) for the IP phone, configure the parameter "lang.gui = Guilan".</p> <p>Web User Interface: None</p> <p>Phone User Interface: Menu->Settings->Basic Settings->Language</p>		
lang.wui	Refer to the following content	English
<p>Description: Configures the language used on the web user interface.</p> <p>Permitted Values: English, Chinese_S, Chinese_T, French, German, Italian, Polish, Portuguese, Spanish, Turkish, Russian or the custom language name.</p> <p>Example: lang.wui = English If you want to use the custom language (e.g., Wuilan) for the IP phone, configure the parameter "lang.wui = Wuilan".</p> <p>Note: If the language of your browser is not supported by the IP phone, the web user interface will use English by default.</p> <p>Web User Interface:</p>		

Parameters	Permitted Values	Default
Settings->Preference->Language		
Phone User Interface:		
None		

To specify the language for the web user interface via web user interface:

1. Click on **Settings->Preference**.
2. Select the desired language from the pull-down list of **Language**.

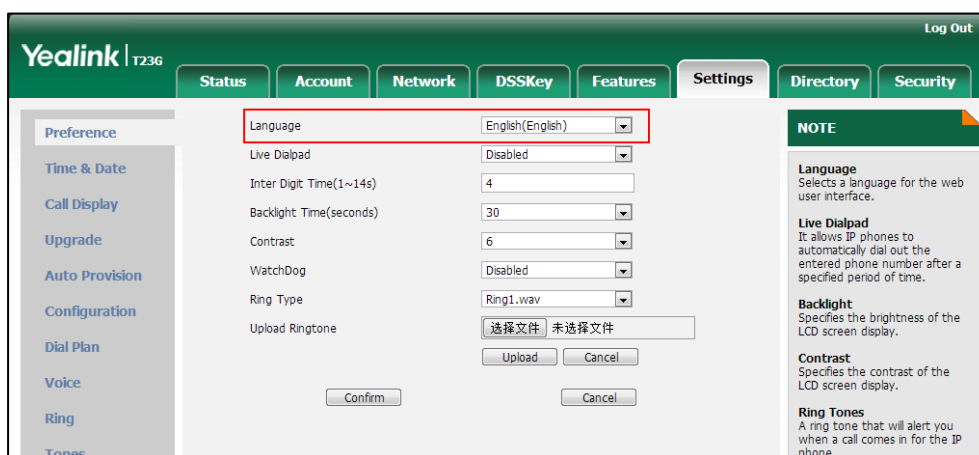

3. Click **Confirm** to accept the change.

To specify the language for the phone user interface via phone user interface:

1. Press **Menu->Settings->Basic Settings->Language**.
2. Press **▲** or **▼** to select the desired language.
3. Press the **Save** soft key to accept the change.

Input Method

Input Method Customization

Input method customization allows users to customize the existing input method on IP phones. You can first customize the Yealink-supplied input method file "ime.txt" or "Russian_ime.txt", and then download it to the IP phone. The changes in the "Russian_ime.txt" file becomes affective when the language is set to Russian. The changes in the "ime.txt" file is affective for all the languages. IP phones support 6 input methods: 2aB, abc, Abc, 123, ABC and Hebrew. By default, Hebrew input method is hidden, you can manually configure the IP phone to display the Hebrew input method.

If you just want to customize the input method for a certain language, the filename must be formatted as "language name_ime.txt" (e.g., German_ime.txt).

You can ask the distributor or Yealink FAE for input method file. You can also obtain the input method file online:

<http://support.yealink.com/documentFront/forwardToDocumentFrontDisplayPage>. For more information on obtaining the input method file, refer to [Obtaining Configuration Files and Resource Files](#) on page 42.

The following shows a portion of the input method file “ime.txt”:

```

ime.txt x
1 [2aB]
2 1 = "1"
3 2 = "2abcABC"
4 3 = "3defDEF"
5 4 = "4ghiGHI"
6 5 = "5jklJKL"
7 6 = "6mnoMNO"
8 7 = "7pqrsPQRS"
9 8 = "8tuvTUV"
10 9 = "9wxyzWXYZ"
11 0 = "0"
12 * = "*, '?!\-()@/;+&%=<>£$%&[]{}~^_`|"
13 # = "#"
14
15 [abc]
16 1 = ""
17 2 = "abc2äääääääç"
18 3 = "def3ééééèð"
19 4 = "ghi4ííííî"
20 5 = "jkl5ÿ"
21 6 = "mno6öóòóðñ"
22 7 = "pqr7ßš"
23 8 = "tuv8ùúúúü"
24 9 = "wxyz9ýÿ"
25 0 = ""
26 * = "*, '?!\-()@/;+&%=<>£$%&[]{}~^_`|"
27 # = "#"
    
```

The following shows a portion of the input method file “Russian_ime.txt”:

```

C:\Users\yl0817\Desktop\Russian_ime.txt
1 [2aB]
2 1 = "1"
3 2 = "АВВГабвр2ABCabc"
4 3 = "ДЕЖЗдежз3DEFdef"
5 4 = "ИЙКЛийкл4GHIghi"
6 5 = "МНОПмпноп5JKLjkl"
7 6 = "РСТУрсту6MNOmno"
8 7 = "ФХЦфхцч7PQRSpqrs"
9 8 = "ШШЪЫИШъы8TUVtuv"
10 9 = "ЪЮЯъюя9WXYZwxyz"
11 0 = "0"
12 * = "*, '?!\-()@/;+&%=<>£$%&[]{}~^_`|"
13 # = "#"
14
15
16 [ABC]
17 1 = ".,?!|@' _() ;&/%*#+<=>"$%&[]{}~^_`|"
18 2 = "АВВГАВС"
19 3 = "ДЕЖЗДЕФ"
20 4 = "ИЙКЛГHI"
21 5 = "МНОПJKL"
22 6 = "РСТУMNO"
23 7 = "ФХЦПQRS"
24 8 = "ШШЪЫTUV"
25 9 = "ЪЮЯWXYZ"
26 0 = "0"
27 * = "*, '?!\-()@/;+&%=<>£$%&[]{}~^_`|"
28 # = "#"
    
```

To customize an input method file:

1. Open the desired input method file (e.g., ime.txt) using an ASCII editor.
2. Under the input method field (e.g., [abc]), add new characters or adjust the characters order within the double quotation marks on the right of the equal sign.
Don't modify the item on the left of the equal sign.

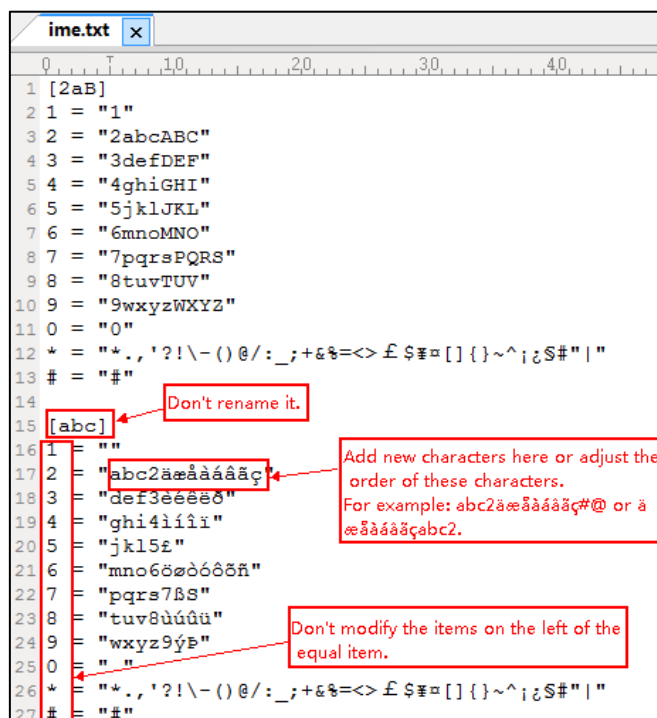

3. Save the input method file and place it to the provisioning server (e.g., 192.168.10.25).
4. Specify the access URL of the custom input method file in the configuration files.

Note When adding new characters for the existing input method, ensure that the added characters are supported by IP phones.
The IP phones can only recognize the input method files uploaded using Unicode encoding.
Do not rename the input method filename.

Procedure

Specify the access URL of the custom input method file using the configuration files.

<p>Configuration File</p>	<p><y0000000000xx>.cfg</p>	<p>Specify the access URL of the custom input method file.</p> <p>Parameter:</p> <p>gui_input_method.url</p> <p>Delete custom input method file of the phone user interface.</p>
----------------------------------	----------------------------------	---

		<p>Parameter: gui_input_method.delete</p> <p>Configure the phone to display the Hebrew input method.</p> <p>Parameter: features.input.hebrew_enable</p>
--	--	---

Details of Configuration Parameters:

Parameters	Permitted Values	Default
gui_input_method.url	URL within 511 characters	Blank
<p>Description: Configures the access URL of the custom input method file.</p> <p>Example: gui_input_method.url = http://192.168.10.25/ime.txt</p> <p>During the auto provisioning process, the IP phone connects to the provisioning server "192.168.1.25", and downloads the custom input method file "ime.txt".</p> <p>gui_input_method.url = http://192.168.10.25/Russian_ime.txt.</p> <p>During the auto provisioning process, the IP phone connects to the provisioning server "192.168.1.25", and downloads the custom input method file "Russian_ime.txt" for Russian language.</p> <p>Note: If you want to upload a custom input method file for the desired language, you can name the file "language name_ime.txt".</p> <p>Web User Interface: None</p> <p>Phone User Interface: None</p>		
gui_input_method.delete	http://localhost/all or http://localhost/ <i>name.txt</i>	Blank
<p>Description: Delete the specified or all custom input method files of the phone user interface.</p> <p>Example: Delete all custom input method files: gui_input_method.delete = http://localhost/all</p> <p>Delete a custom input method file (e.g., ime.txt) for the phone: gui_input_method.delete = http://localhost/ime.txt</p>		

Parameters	Permitted Values	Default
Web User Interface: None Phone User Interface: None		
features.input.hebrew_enable	0 or 1	0
Description: Enables or disables the IP phone to display the Hebrew input method. 0-Disabled 1-Enabled Note: If you change this parameter, the IP phone will reboot to make the change take effect. Web User Interface: None Phone User Interface: None		

Specifying the Default Input Method

In addition to customizing the input method file, you can also specify the default input method for the IP phone when editing or searching for contacts.

Procedure

Specify the default input methods using the configuration files.

Configuration File	<y0000000000xx>.cfg	Specify the default input method when editing contacts. Parameter: directory.edit_default_input_method Specify the default input method when searching for contacts. Parameter: directory.search_default_input_method
---------------------------	---------------------	--

Details of Configuration Parameters:

Parameters	Permitted Values	Default
<code>directory.edit_default_input_method</code>	Abc, 2aB, 123, abc or ABC	Abc
<p>Description: Configures the default input method when the user edits contacts in the Local Directory, LDAP, Remote Phone Book or Blacklist.</p> <p>Example: <code>directory.edit_default_input_method = abc</code></p> <p>Web User Interface: None</p> <p>Phone User Interface: None</p>		
<code>directory.search_default_input_method</code>	Abc, 2aB, 123, abc or ABC	Abc
<p>Description: Configures the default input method when the user searches for contacts in the Local Directory, LDAP, Remote Phone Book or Blacklist.</p> <p>Example: <code>directory.search_default_input_method = abc</code></p> <p>Web User Interface: None</p> <p>Phone User Interface: None</p>		

Logo Customization

Logo customization allows unifying the IP phone appearance or displaying a custom image on the idle screen such as a company logo, instead of the default system logo. Logo is not applicable to SIP-T48G, SIP-T46G and SIP-T29G IP phones. These three IP phone models use wallpaper instead. For more information on wallpaper, refer to [Wallpaper](#) on page 99.

The following table lists the supported logo file format and resolution for each phone model.

Phone Model	Logo File Format	Resolution
SIP-T42G/T41P	.dob	<=192*64 2 gray scale

Phone Model	Logo File Format	Resolution
SIP-T27P	.dob	$\leq 240 \times 120$ 2 gray scale
SIP-T23P/T23G/T21(P) E2/T19(P) E2	.dob	$\leq 132 \times 64$ 2 gray scale

Note

Before uploading your custom logo to IP phones, ensure your logo file is correctly formatted.

Customizing a Logo Template File

The common picture format can be *.gif/*.jpg/*.png/*.bmp. Yealink IP phones only support the *.dob format logo files. Yealink provides PictureExDemo tool to convert *.gif/*.jpg/*.png/*.bmp format to *.dob format. You can ask the distributor or Yealink FAE for the PictureExDemo tool.

To customize a dob formatted logo file using the PictureExDemo tool:

1. Double click the PictureExDemo.exe.



2. Click **Add** button to open a *.gif/*.jpg/*.png/*.bmp file.
You can repeat the second step to add multiple original picture files.

3. Click the **Convert** button.

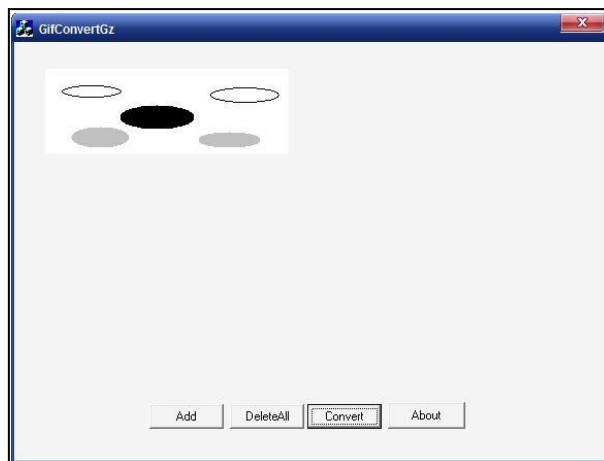

Then you can find the **DOB** logo files in the **adv** directory.

Configuring the Logo Shown on the Idle Screen

Procedure

The logo shown on the idle screen can be configured using the configuration files or locally.

<p>Configuration File</p>	<p><y0000000000xx>.cfg</p>	<p>Configure the logo shown on the idle screen.</p> <p>Parameters: phone_setting.lcd_logo.mode Specify the access URL of the custom logo file.</p> <p>Parameters: lcd_logo.url Delete all custom logo files.</p> <p>Parameters: lcd_logo.delete</p>
<p>Local</p>	<p>Web User Interface</p>	<p>Configure the logo shown on the idle screen.</p> <p>Navigate to: http://<phoneIPAddress>/servlet?p=features-general&q=load</p>

Details of Configuration Parameters:

Parameters	Permitted Values	Default
phone_setting.lcd_logo.mode	0, 1 or 2	0
<p>Description: Configures the logo mode of the LCD screen.</p> <p>0-Off 1-System logo 2-Custom logo</p> <p>If it is set to 0 (Off), the IP phone is not allowed to display a logo. If it is set to 1 (System logo), the LCD screen will display the system logo. If it is set to 2 (Custom logo), the LCD screen will display the custom logo (you need to upload a custom logo file to the IP phone).</p> <p>Note: It is not applicable to SIP-T48G/T46G/T29G IP phones.</p> <p>Web User Interface: Features->General Information->Use Logo</p> <p>Phone User Interface: None</p>		
lcd_logo.url	URL within 511 characters	Blank
<p>Description: Configures the access URL of the custom logo file.</p> <p>Example: lcd_logo.url = http://192.168.10.25/logo.dob</p> <p>During the auto provisioning process, the IP phone connects to the provisioning server "192.168.10.25", and downloads the custom logo file "logo.dob".</p> <p>Note: It works only if the value of the parameter "phone_setting.lcd_logo.mode" is set to 2 (Custom logo). It is not applicable to SIP-T48G/T46G/T29G IP phones.</p> <p>Web User Interface: Features->General Information->Upload Logo</p> <p>Phone User Interface: None</p>		
lcd_logo.delete	http://localhost/all	Blank

Parameters	Permitted Values	Default
<p>Description: Deletes all custom logo files.</p> <p>Example: lcd_logo.delete = http://localhost/all</p> <p>Note: It is not applicable to SIP-T48G/T46G/T29G IP phones.</p> <p>Web User Interface: None</p> <p>Phone User Interface: None</p>		

To configure an image logo via web user interface:

1. Click on **Features->General Information**.
2. Select **Custom logo** from the pull-down list of **Use Logo**.
3. Click **Browse** to select the logo file from your local system.
4. Click **Upload** to upload the file.

The screenshot shows the Yealink T236 web interface. The 'Features' tab is selected, and the 'General Information' sub-tab is active. The 'Use Logo' dropdown menu is set to 'Custom logo'. Below it, the 'Upload Logo' section is highlighted with a red box, containing a 'Browse...' button, 'Upload', and 'Cancel' buttons. The text 'No file selected.' is displayed next to the 'Browse...' button. The 'NOTE' sidebar on the right contains the following information:

- Call Waiting:** It allows IP phones to receive a new incoming call when there is already an active call.
- Auto Redial:** It allows IP phones to automatically redial a busy number after the first attempt.
- Key As Send:** Assigns '#' or '*' as the send key.
- Hotline:** IP phone will automatically dial out the hotline number when lifting the handset, pressing the speakerphone key or the line key.
- Call Completion:** It allows users to monitor the busy party and establish a call when the busy party becomes available to receive a call.

5. Click **Confirm** to accept the change.

The image logo screen and the idle screen are displayed alternately.

Softkey Layout

Softkey layout is used to customize the soft keys at the bottom of the LCD screen to best meet users' requirements. In addition to specifying which soft keys to display, you can determine their display order. It can be configured based on call states.

You can configure the softkey layout using the softkey layout templates for different call states. For more information on how to configure a softkey layout template, refer to [Customizing Softkey Layout Template File](#) on page 169.

Procedure

Softkey layout can be configured using the configuration files or locally.

Configuration File	<y0000000000xx>.cfg	Configure the softkey layout. Parameters: phone_setting.custom_softkey_enable
Local	Web User Interface	Configure the softkey layout. Navigate to: http://<phoneIPAddress>/servlet?p=settings-softkey&q=load

Details of Configuration Parameters:



Parameters	Permitted Values	Default
phone_setting.custom_softkey_enable	0 or 1	0
<p>Description: Enables or disables custom soft keys layout feature.</p> <p>0-Disabled 1-Enabled</p> <p>Web User Interface: Settings->Softkey Layout->Custom Softkey</p> <p>Phone User Interface: None</p>		

To configure softkey layout via web user interface:

1. Click on **Settings->Softkey Layout**.
2. Select the desired value from the pull-down list of **Custom Softkey**.
3. Select the desired state from the pull-down list of **Call States**.
4. Select the desired soft key from the **Unselected Softkeys** column and then click  .

The selected soft key appears in the **Selected Softkeys** column. If more than four soft keys are selected, a **More** soft key will appear on the LCD screen, and the selected soft keys are displayed in two pages.

5. Repeat the step 4 to add more soft keys to the **Selected Softkeys** column.

6. To remove the soft key from the **Selected Softkeys** column, select the desired soft key and then click  .
7. To adjust the display order of soft keys, select the desired soft key and then click  or  .

The LCD screen displays the soft keys in the adjusted order.

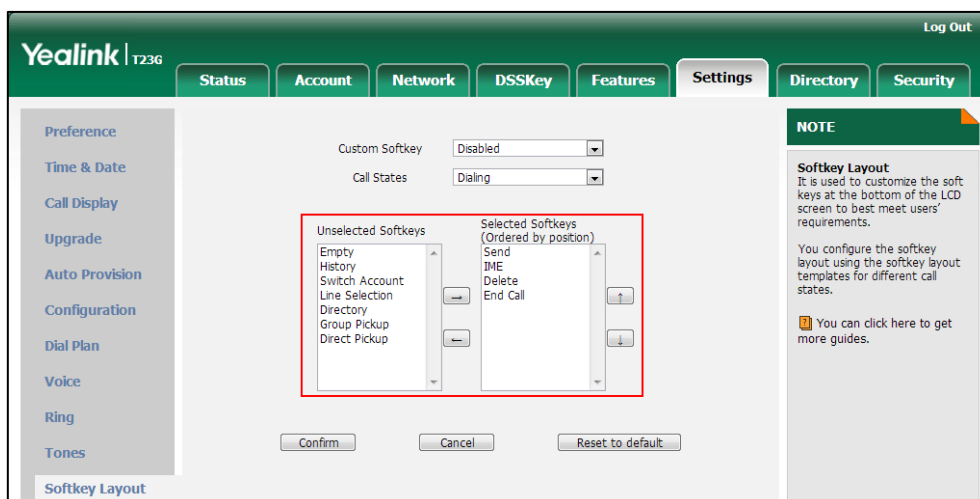

8. Click **Confirm** to accept the change.

Customizing Softkey Layout Template File

The softkey layout template allows you to customize soft key layout for different call states. The call states include CallFailed, CallIn, Connecting, Dialing (not applicable to SIP-T48G), RingBack and Talking.

You can ask the distributor or Yealink FAE for softkey layout template. You can also obtain the softkey layout template online:

<http://support.yealink.com/documentFront/forwardToDocumentFrontDisplayPage>. For more information on obtaining the softkey layout template, refer to [Obtaining Configuration Files and Resource Files](#) on page 42.

The following table lists soft keys available for IP phones in different call states.

Call State	Default Soft Keys	Optional Soft Keys
CallFailed	NewCall Empty Empty Empty	Empty Switch Cancel (End Call)
CallIn	Answer Forward Silence	Empty Switch

Call State		Default Soft Keys	Optional Soft Keys
		Reject	
Connecting	Connecting	Empty Empty Empty Cancel (End Call)	Empty Switch
	SemiAttendTrans	Transfer Empty Empty Cancel (End Call)	Empty Switch
Dialing (not applicable to SIP-T48G)		Send IME Delete Cancel (End Call)	Empty History Switch Line Favorite (Directory) GPickup DPickup Retrieve
RingBack	RingBack	Empty Empty Empty Cancel (End Call)	Empty Switch
	SemiAttendTransBack	Transfer Empty Empty Cancel (End Call)	Empty Switch
Talking	Talk	Transfer Hold Conference Cancel (End Call)	Empty Mute SWAP NewCall Switch Answer Reject PriHold Park

Call State		Default Soft Keys	Optional Soft Keys
			GPark RTP Status
	Hold	Transfer Resume NewCall Cancel (End Call)	Empty Switch Answer Reject
	Held	Empty Empty Empty Cancel (End Call)	Empty Switch Answer Reject NewCall
	PreTrans (not applicable to SIP-T48G)	Transfer IME Delete Cancel (End Call)	Empty Directory Switch Send
	Conferenced	Empty Hold Split Cancel (End Call)	Empty Switch Answer Reject Mute Manager RTP Status

When editing a softkey layout template, learn the following:

- `<Call States>` indicates the start of a template and `</Call States>` indicates the end of a template. For example, `<CallFailed> </CallFailed>`.
- `<Disable>` indicates the start of the disabled soft key list and `</Disable>` indicates the end of the soft key list. The disabled soft keys are not displayed on the LCD screen.
- Create disabled soft keys between `<Disable>` and `</Disable>`.
- `<Enable>` indicates the start of the enabled soft key list and `</Enable>` indicates the end of the soft key list. The enabled soft keys are displayed on the LCD screen.
- Create enabled soft keys between `<Enable>` and `</Enable>`.
- `<Default>` indicates the start of the default soft key list and `</Default>` indicates the end of the default soft key list. The default soft keys are displayed on the LCD screen by default.

To customize a softkey layout template:

1. Open the template file using an ASCII editor.
2. For each soft key that you want to enable, move the string in the disabled soft key list to enabled soft key list in the file.

```

1 <CallFailed>
2   <Disable>
3     <Key Type="Empty"/>
4     <Key Type="Switch"/>
5     <Key Type="Cancel"/>
6   </Disable>
7   <Enable>
8     <Key Type="NewCall"/>
9     <Key Type="Empty"/>
10    <Key Type="Empty"/>
11    <Key Type="Empty"/>
12  </Enable>
13  <Default>
14    <Key Type="NewCall"/>
15    <Key Type="Empty"/>
16    <Key Type="Empty"/>
17    <Key Type="Empty"/>
18  </Default>
19 </CallFailed>
20
    
```

For each soft key that you want to disabled, just move the string in the enabled soft key list to disabled soft key list.

```

1 <CallFailed>
2   <Disable>
3     <Key Type="Empty"/>
4     <Key Type="Switch"/>
5     <Key Type="Cancel"/>
6   </Disable>
7   <Enable>
8     <Key Type="NewCall"/>
9     <Key Type="Empty"/>
10    <Key Type="Empty"/>
11    <Key Type="Empty"/>
12  </Enable>
13  <Default>
14    <Key Type="NewCall"/>
15    <Key Type="Empty"/>
16    <Key Type="Empty"/>
17    <Key Type="Empty"/>
18  </Default>
19 </CallFailed>
20
    
```

3. Save the change and place this file to the provisioning server.
4. Specify the access URL of the softkey layout template in the configuration files.

Procedure

Specify the access URL of the softkey layout template using configuration files.

Configuration File	<y0000000000xx>.cfg	Specify the access URL of the softkey layout template. Parameters: custom_softkey_call_failed.url custom_softkey_call_in.url custom_softkey_connecting.url custom_softkey_dialing.url custom_softkey_ring_back.url custom_softkey_talking.url
---------------------------	---------------------	---

Details of Configuration Parameters:

Parameters	Permitted Values	Default
custom_softkey_call_failed.url	URL within 511 characters	Blank
<p>Description: Configures the access URL of the custom file for the soft key presented on the LCD screen when in the CallFailed state.</p> <p>Example: custom_softkey_call_failed.url = http:// 192.168.1.20/XMLfiles/CallFailed.xml During the auto provisioning process, the IP phone connects to the provisioning server "192.168.1.20", and downloads the CallFailed state file from the "XMLfiles" directory.</p> <p>Web User Interface: None</p> <p>Phone User Interface: None</p>		
custom_softkey_call_in.url	URL within 511 characters	Blank
<p>Description: Configures the access URL of the custom file for the soft key presented on the LCD screen when in the CallIn state.</p> <p>Example:</p>		

Parameters	Permitted Values	Default
<p>custom_softkey_call_in.url = http://192.168.1.20/XMLfiles/CallIn.xml</p> <p>During the auto provisioning process, the IP phone connects to the provisioning server "192.168.1.20", and downloads the CallIn state file from the "XMLfiles" directory.</p> <p>Web User Interface: None</p> <p>Phone User Interface: None</p>		
custom_softkey_connecting.url	URL within 511 characters	Blank
<p>Description: Configures the access URL of the custom file for the soft key presented on the LCD screen when in the Connecting state.</p> <p>Example: custom_softkey_connecting.url = http://192.168.1.20/XMLfiles/Connecting.xml</p> <p>During the auto provisioning process, the IP phone connects to the provisioning server "192.168.1.20", and downloads the Connecting state file from the "XMLfiles" directory.</p> <p>Web User Interface: None</p> <p>Phone User Interface: None</p>		
custom_softkey_dialing.url	URL within 511 characters	Blank
<p>Description: Configures the access URL of the custom file for the soft key presented on the LCD screen when in the Dialing state.</p> <p>Example: custom_softkey_dialing.url = http://192.168.1.20/XMLfiles/Dialing.xml</p> <p>During the auto provisioning process, the IP phone connects to the provisioning server "192.168.1.20", and downloads the Dialing state file from the "XMLfiles" directory.</p> <p>Web User Interface: None</p> <p>Phone User Interface: None</p>		

Parameters	Permitted Values	Default
<code>custom_softkey_ring_back.url</code>	URL within 511 characters	Blank
<p>Description: Configures the access URL of the custom file for the soft key presented on the LCD screen when in the RingBack state.</p> <p>Example: <code>custom_softkey_ring_back.url = http://192.168.1.20/XMLfiles/RingBack.xml</code> During the auto provisioning process, the IP phone connects to the provisioning server "192.168.1.20", and downloads the RingBack state file from the "XMLfiles" directory.</p> <p>Web User Interface: None</p> <p>Phone User Interface: None</p>		
<code>custom_softkey_talking.url</code>	URL within 511 characters	Blank
<p>Description: Configures the access URL of the custom file for the soft key presented on the LCD screen when in the Talking state.</p> <p>Example: <code>custom_softkey_talking.url = http://192.168.1.20/XMLfiles/Talking.xml</code> During the auto provisioning process, the IP phone connects to the provisioning server "192.168.1.20", and downloads the Talking state file from the "XMLfiles" directory.</p> <p>Web User Interface: None</p> <p>Phone User Interface: None</p>		

Key As Send

Key as send allows assigning the pound key or asterisk key as the send key.

Send sound allows the IP phone to play a key tone when a user presses the send key.

Key tone allows the IP phone to play a key tone when a user presses any key. Send sound works only if key tone is enabled.

Procedure

Key as send can be configured using the configuration files or locally.

<p>Configuration File</p>	<p><y0000000000xx>.cfg</p>	<p>Configure a send key. Parameter: features.key_as_send Configure a send sound. Parameter: features.send_key_tone Configure a key tone. Parameter: features.key_tone</p>
<p>Local</p>	<p>Web User Interface</p>	<p>Configure a send key. Navigate to: http://<phoneIPAddress>/servlet ?p=features-general&q=load Configure a send sound and key tone. Navigate to: http://<phoneIPAddress>/servlet ?p=features-audio&q=load</p>
	<p>Phone User Interface</p>	<p>Configure a send key. Configure a key tone.</p>

Details of Configuration Parameters:

Parameters	Permitted Values	Default
<p>features.key_as_send</p>	<p>0, 1 or 2</p>	<p>1</p>
<p>Description: Configures the "#" or "*" key as the send key. 0-Disabled 1-# key 2-* key If it is set to 0 (Disabled), neither "#" nor "*" can be used as the send key. If it is set to 1 (# key), the pound key is used as the send key. If it is set to 2 (* key), the asterisk key is used as the send key. Web User Interface:</p>		

Parameters	Permitted Values	Default
Features->General Information->Key As Send Phone User Interface: Menu->Features->Key as send		
features.key_tone	0 or 1	1
Description: Enables or disables the IP phone to play a key tone when a user presses any key on your phone keypad. 0 -Disabled 1 -Enabled If it is set to 1 (Enabled), the IP phone will play a key tone when a user presses any key on your phone keypad. Web User Interface: Features->Audio->Key Tone Phone User Interface: Menu->Settings->Basic Settings->Sound->Key Tone		
features.send_key_tone	0 or 1	1
Description: Enables or disables the IP phone to play a key tone when a user presses a send key. 0 -Disabled 1 -Enabled If it is set to 1 (Enabled), the IP phone will play a key tone when a user presses a send key. Note: It works only if the value of the parameter "features.key_tone" is set to 1 (Enabled). Web User Interface: Features->Audio->Send Tone Phone User Interface: None		

To configure a send key via web user interface:

1. Click on **Features->General Information**.

2. Select the desired value from the pull-down list of **Key As Send**.

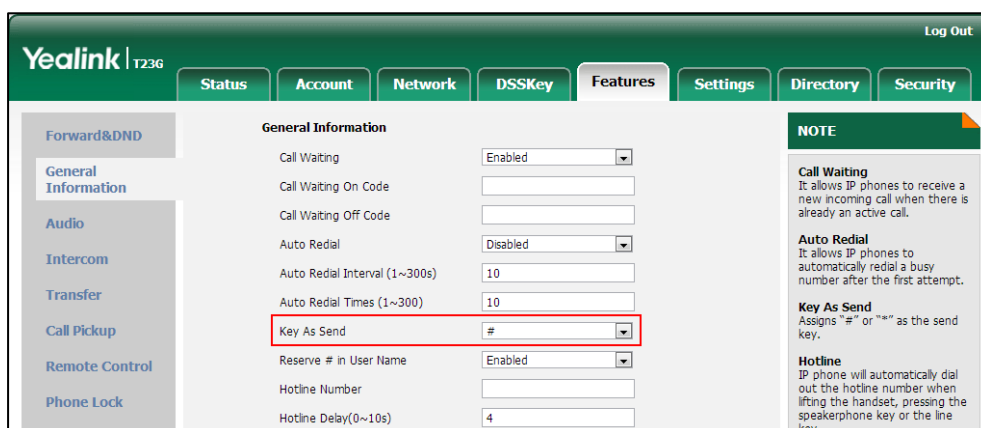

3. Click **Confirm** to accept the change.

To configure a send sound and key tone via web user interface:

1. Click on **Features->Audio**.
2. Select the desired value from the pull-down list of **Key Tone**.
3. Select the desired value from the pull-down list of **Send Tone**.

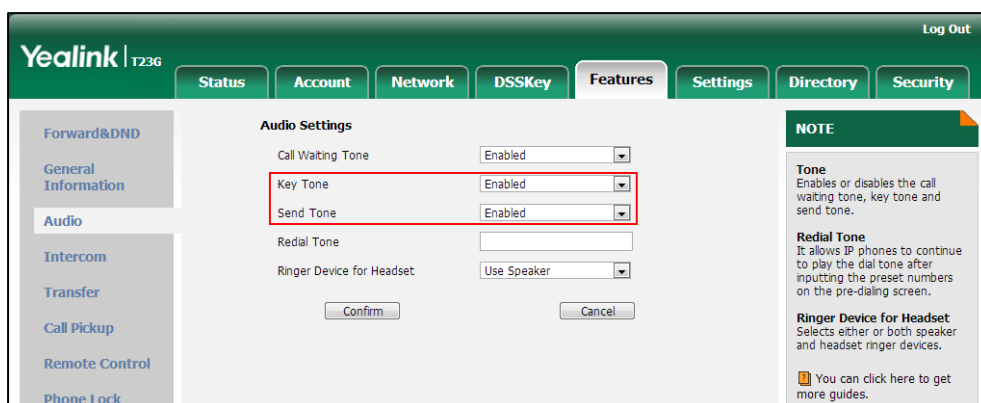

4. Click **Confirm** to accept the change.

To configure a send key via phone user interface:

1. Press **Menu->Features->Key as send**.
2. Press **◀** or **▶**, or the **Switch** soft key to select **#** or ***** from the **Key as send** field, or select **Disabled** to disable this feature.
3. Press the **Save** soft key to accept the change.

To configure a key tone via web user interface:

1. Press **Menu->Settings->Basic Settings->Sound->Key Tone**.
2. Press **◀** or **▶**, or the **Switch** soft key to select the desired value from the **Key Tone** field.
3. Press the **Save** soft key to accept the change.

Dial Plan

Regular expression, often called a pattern, is an expression that specifies a set of strings. A regular expression provides a concise and flexible means to “match” (specify and recognize) strings of text, such as particular characters, words, or patterns of characters. Regular expression is used by many text editors, utilities, and programming languages to search and manipulate text based on patterns.

Regular expression can be used to define IP phone dial plan. Dial plan is a string of characters that governs the way for IP phones to process the inputs received from the IP phone’s keypads. IP phones support the following dial plan features:

- [Replace Rule](#)
- [Dial-now](#)
- [Area Code](#)
- [Block Out](#)

You need to know the following basic regular expression syntax when creating dial plan:

.	The dot “.” can be used as a placeholder or multiple placeholders for any string. Example: “12.” would match “123”, “1234”, “12345”, “12abc”, etc.
x	The “x” can be used as a placeholder for any character. Example: “12x” would match “121”, “122”, “123”, “12a”, etc.
-	The dash “-” can be used to match a range of characters within the brackets. Example: “[5-7]” would match the number “5”, “6” or “7”.
,	The comma “,” can be used as a separator within the bracket. Example: “[2,5,8]” would match the number “2”, “5” or “8”.
[]	The square bracket “[]” can be used as a placeholder for a single character which matches any of a set of characters. Example: “91[5-7]1234” would match “9151234”, “9161234”, “9171234”.
()	The parenthesis “()” can be used to group together patterns, for instance, to logically combine two or more patterns. Example: “([1-9])([2-7])3” would match “923”, “153”, “673”, etc.
\$	The “\$” followed by the sequence number of a parenthesis means the characters placed in the parenthesis. The sequence number stands for the corresponding parenthesis. Example: A replace rule configuration, Prefix: “001(xxx)45(xx)”, Replace:

	"9001\$145\$2". When you dial out "0012354599" on your phone, the IP phone will replace the number with "9001 235 4599". "\$1" means 3 digits in the first parenthesis, that is, "235". "\$2" means 2 digits in the second parenthesis, that is, "99".
--	---

Replace Rule

Replace rule is an alternative string that replaces the numbers entered by the user. IP phones support up to 100 replace rules, which can be created either one by one or in batch using a replace rule template. For more information on how to customize a replace rule template, refer to [Customizing Replace Rule Template File](#) on page 182.

Procedure

Replace rule can be created using the configuration files or locally.

Configuration File	<code><y0000000000xx>.cfg</code>	Create the replace rule for the IP phone. Parameters: dialplan.replace.prefix.X dialplan.replace.replace.X dialplan.replace.line_id.X
Local	Web User Interface	Create the replace rule for the IP phone. Navigate to: http://<phoneIPAddress>/servlet?p=settings-dialplan&q=load

Details of Configuration Parameters:

Parameters	Permitted Values	Default
dialplan.replace.prefix.X (X ranges from 1 to 100)	String within 32 characters	Blank
Description: Configures the entered number to be replaced. Example: dialplan.replace.prefix.1 = 1 Web User Interface: Settings->Dial Plan->Replace Rule->Prefix Phone User Interface:		

Parameters	Permitted Values	Default
None		
dialplan.replace.replace.X (X ranges from 1 to 100)	String within 32 characters	Blank
<p>Description: Configures the alternate number to replace the entered number.</p> <p>Example: dialplan.replace.prefix.1 = 1 and dialplan.replace.replace.1 = 123456 When you enter the number "1" and press the send key, the entered number "1" will be replaced by the number "123456".</p> <p>Web User Interface: Settings->Dial Plan->Replace Rule->Replace</p> <p>Phone User Interface: None</p>		
dialplan.replace.line_id.X (X ranges from 1 to 100)	Refer to the following content	Blank (for all lines)
<p>Description: Configures the desired line to apply the replace rule. The digit 0 stands for all lines. If it is left blank, the replace rule will apply to all lines on the IP phone.</p> <p>Permitted Values: 0 to 16 (for SIP-T48G/T46G/T29G) 0 to 12 (for SIP-T42G) 0 to 6 (for SIP-T41P/T27P) 0 to 3 (for SIP-T23P/G) 0 to 2 (for SIP-T21(P) E2)</p> <p>Example: dialplan.replace.line_id.1 = 1,2</p> <p>Note: Multiple line IDs are separated by commas. It is not applicable to SIP-T19(P) E2 IP phones.</p> <p>Web User Interface: Settings->Dial Plan->Replace Rule->Account</p> <p>Phone User Interface: None</p>		

To create a replace rule via web user interface:

1. Click on **Settings->Dial Plan->Replace Rule**.

2. Enter the string in the **Prefix** field.
3. Enter the string in the **Replace** field.
4. Enter the desired line ID in the **Account** field or leave it blank.

If you leave this field blank or enter 0, the replace rule will apply to all accounts on the IP phone.

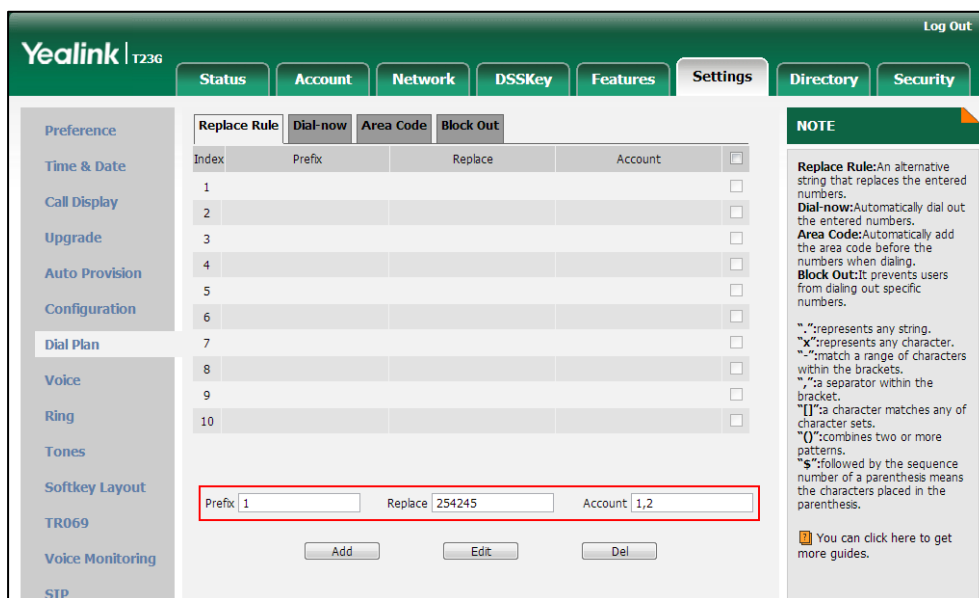

5. Click **Add** to add the replace rule.

Customizing Replace Rule Template File

The replace rule template helps with the creation of multiple replace rules.

You can ask the distributor or Yealink FAE for replace rule template. You can also obtain the replace rule template online:

<http://support.yealink.com/documentFront/forwardToDocumentFrontDisplayPage>. For more information on obtaining the replace rule template, refer to [Obtaining Configuration Files and Resource Files](#) on page 42.

When editing a replace rule template file, learn the following:

- <DialRule> indicates the start of the template file and </DialRule> indicates the end of the template file.
- When specifying the desired line(s) to apply the replace rule, the valid values are 0 and line ID. Multiple line IDs are separated by commas. This is not applicable to SIP-T19(P) E2 IP phones.

The following table lists valid values of line ID for each phone model.

Phone Model	Values	Description
SIP-T48G/T46G/T29G	0~16	0 stands for all lines 1~16 stand for line1~line16

SIP-T42G	0~12	0 stands for all lines 1~12 stand for line1~line12
SIP-T41P/T27P	0~6	0 stands for all lines 1~6 stand for line1~line6
SIP-T23P/G	0~3	0 stands for all lines 1~3 stand for line1~line3
SIP-T21(P) E2	0~2	0 stands for all lines 1~2 stand for line1~line2

- At most 100 replace rules can be added to the IP phone.

The expression syntax in the replace rule template is the same as that introduced in the section [Dial Plan](#) on page 179.

To customize a replace rule template:

- Open the template file using an ASCII editor.
- Create replace rules between <DialRule> and </DialRule>.

For example:

```
<Data Prefix="2512" Replace="05922512" LineID="1" />
```

Where:

Prefix="" specifies the numbers to be replaced.

Replace="" specifies the alternate string instead of what the user enters.

LineID="" specifies the desired line(s) for this rule. When you leave it blank or enter 0, this replace rule will apply to all lines.

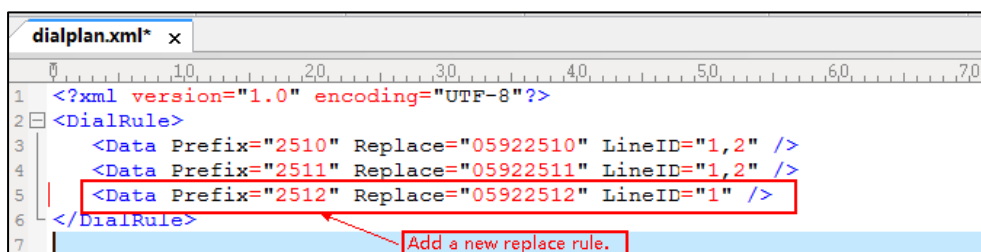

If you want to change the replace rule, specify the values within double quotes.

- Save the change and place this file to the provisioning server.
- Specify the access URL of the replace rule template in the configuration files.

Procedure

Specify the access URL of the replace rule template using configuration files.

Configuration File	<y0000000000xx>.cfg	Specify the access URL of the replace rule template. Parameter: dialplan_replace_rule.url
---------------------------	---------------------	--

Details of Configuration Parameters:

Parameters	Permitted Values	Default
dialplan_replace_rule.url	URL within 511 characters	Blank
<p>Description: Configures the access URL of the replace rule template file.</p> <p>Example: dialplan_replace_rule.url = http://192.168.10.25/dialplan.xml</p> <p>During the auto provisioning process, the IP phone connects to the provisioning server "192.168.10.25", and downloads the replace rule file "dialplan.xml".</p> <p>Web User Interface: None</p> <p>Phone User Interface: None</p>		

Dial-now

Dial-now is a string used to match numbers entered by the user. When entered numbers match the predefined dial-now rule, the IP phone will automatically dial out the numbers without pressing the send key. IP phones support up to 100 dial-now rules, which can be created either one by one or in batch using a dial-now rule template. For more information on how to customize a dial-now template, refer to [Customizing Dial-now Template File](#) on page 187.

Delay Time for Dial-now Rule

The IP phone will automatically dial out the entered number, which matches the dial-now rule, after a specified period of time.

Procedure

Dial-now rule can be created using the configuration files or locally.

Configuration File	<code><y0000000000xx>.cfg</code>	<p>Create the dial-now rule for the IP phone.</p> <p>Parameters: dialplan.dialnow.rule.X dialplan.dialnow.line_id.X</p> <p>Configure the delay time for the dial-now rule.</p>
---------------------------	--	---

		Parameters: phone_setting.dialnow_delay
Local	Web User Interface	Create the dial-now rule for the IP phone. Navigate to: http://<phoneIPAddress>/servlet?p=settings-dialnow&q=load Configure the delay time for the dial-now rule. Navigate to: http://<phoneIPAddress>/servlet?p=features-general&q=load

Details of Configuration Parameters:

Parameters	Permitted Values	Default
dialplan.dialnow.rule.X (X ranges from 1 to 100)	String within 511 characters	Blank
Description: Configures the dial-now rule (the string used to match the numbers entered by the user). When entered numbers match the predefined dial-now rule, the IP phone will automatically dial out the numbers without pressing the send key. Example: dialplan.dialnow.rule.1 = 123 Web User Interface: Settings->Dial Plan->Dial-now->Rule Phone User Interface: None		
dialplan.dialnow.line_id.X (X ranges from 1 to 100)	Refer to the following content	Blank (for all lines)
Description: Configures the desired line to apply the dial-now rule. The digit 0 stands for all lines. If it is left blank, the dial-now rule will apply to all lines on the IP phone. Permitted Values: 0 to 16 (for SIP-T48G/T46G/T29G) 0 to 12 (for SIP-T42G)		

Parameters	Permitted Values	Default
<p>0 to 6 (for SIP-T41P/T27P) 0 to 3 (for SIP-T23P/G) 0 to 2 (for SIP-T21(P) E2)</p> <p>Example: dialplan.dialnow.line_id.1 = 1,2</p> <p>Note: Multiple line IDs are separated by commas. It is not applicable to SIP-T19(P) E2 IP phones.</p> <p>Web User Interface: Settings->Dial Plan->Dial-now->Account</p> <p>Phone User Interface: None</p>		
phone_setting.dialnow_delay	Integer from 0 to 14	1
<p>Description: Configures the delay time (in seconds) for the dial-now rule. When entered numbers match the predefined dial-now rule, the IP phone will automatically dial out the entered number after the designated delay time.</p> <p>Web User Interface: Features->General Information->Time-Out for Dial-Now Rule</p> <p>Phone User Interface: None</p>		

To create a dial-now rule via web user interface:

1. Click on **Settings->Dial Plan->Dial-now**.
2. Enter the desired value in the **Rule** field.
3. Enter the desired line ID in the **Account** field or leave it blank.

If you leave this field blank or enter 0, the dial-now rule will apply to all accounts on the IP phone.

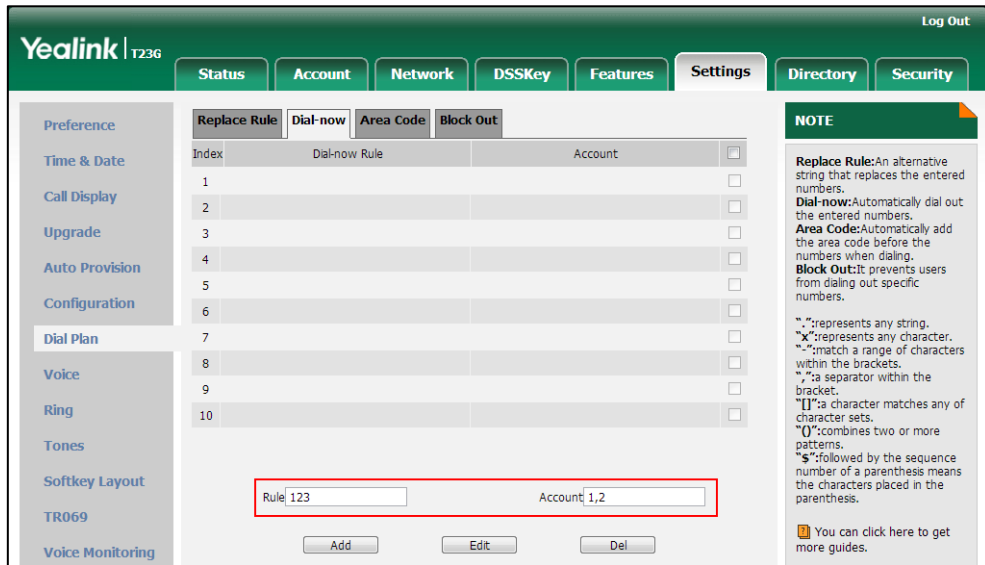

4. Click **Add** to add the dial-now rule.

To configure the delay time for the dial-now rule via web user interface:

1. Click on **Features->General Information**.
2. Enter the desired time within 0-14 (in seconds) in the **Time-Out for Dial-Now Rule** field.

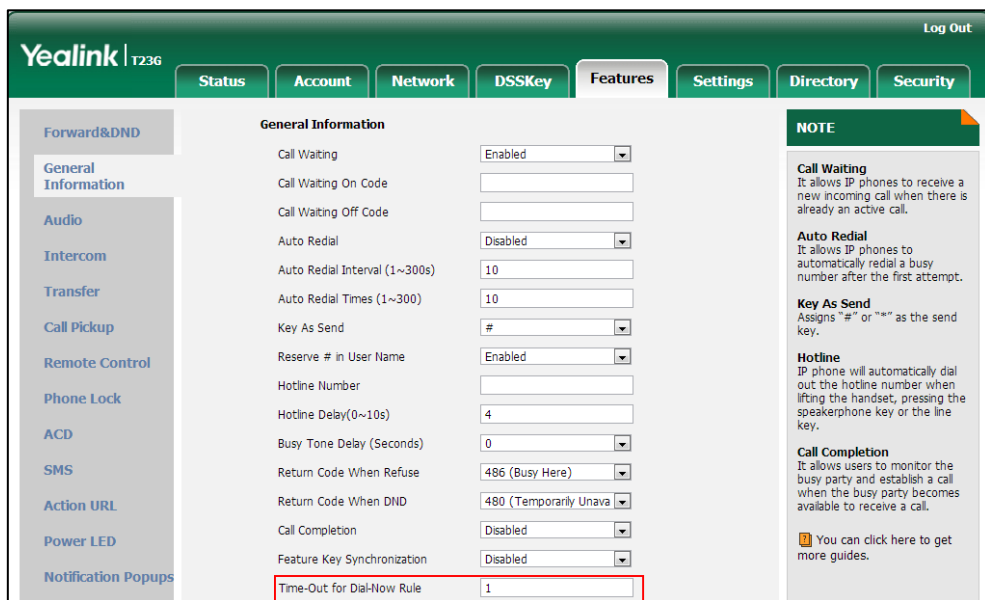

3. Click **Confirm** to accept the change.

Customizing Dial-now Template File

The dial-now template helps with the creation of multiple dial-now rules. After setup,

place the dial-now template to the provisioning server and specify the access URL in the configuration files.

You can ask the distributor or Yealink FAE for dial-now template. You can also obtain the dial-now template online:

<http://support.yealink.com/documentFront/forwardToDocumentFrontDisplayPage>. For more information on obtaining the dial-now template, refer to [Obtaining Configuration Files and Resource Files](#) on page 42.

When editing a dial-now template, learn the following:

- <DialNow> indicates the start of a template and </DialNow> indicates the end of a template.
- When specifying the desired line(s) for the dial-now rule, the valid values are 0 and line ID. Multiple line IDs are separated by commas. This is not applicable to SIP-T19(P) E2 IP phones.

The following table lists valid values of line ID for each phone model.

Phone Model	Values	Description
SIP-T48G/T46G/T29G	0~16	0 stands for all lines 1~16 stand for line1~line16
SIP-T42G	0~12	0 stands for all lines 1~12 stand for line1~line12
SIP-T41P/T27P	0~6	0 stands for all lines 1~6 stand for line1~line6
SIP-T23P/G	0~3	0 stands for all lines 1~3 stand for line1~line3
SIP-T21(P) E2	0~2	0 stands for all lines 1~2 stand for line1~line2

- At most 100 rules can be added to the IP phone.

The expression syntax in the dial-now rule template is the same as that introduced in the section [Dial Plan](#) on page 179.

To customize a dial-now template:

1. Open the template file using an ASCII editor.
2. Create dial-now rules between <DialNow> and </DialNow>.

For example:

```
<Data DialNowRule="1001" LineID="0" />
```

Where:

DialNowRule="" specifies the dial-now rule.

LineID="" specifies the desired line(s) for this rule. When you leave it blank or enter 0, this dial-now rule will apply to all lines.

```

1 <?xml version="1.0" encoding="UTF-8"?>
2 <DialNow>
3   <Data DialNowRule="123" LineID="1,2,3" />
4   <Data DialNowRule="456" LineID="1,2,3" />
5   <Data DialNowRule="1001" LineID="0" />
6 </DialNow>
7
    
```

If you want to change the dial-now rule, specify the values within double quotes.

3. Save the change and place this file to the provisioning server.
4. Specify the access URL of the dial-now template.

Procedure

Specify the access URL of the dial-now template using configuration files.

Configuration File	<code><y0000000000xx>.cfg</code>	Configure the access URL of the dial-now template. Parameter: dialplan_dialnow.url
---------------------------	--	---

Details of Configuration Parameters:

Parameters	Permitted Values	Default
dialplan_dialnow.url	URL within 511 characters	Blank
<p>Description: Configures the access URL of the dial-now rule template file.</p> <p>Example: dialplan_dialnow.url = http://192.168.10.25/dialnow.xml</p> <p>During the auto provisioning process, the IP phone connects to the provisioning server "192.168.10.25", and downloads the dial-now rule file "dialnow.xml".</p> <p>Web User Interface: None</p> <p>Phone User Interface: None</p>		

Area Code

Area codes are also known as Numbering Plan Areas (NPAs). They usually indicate geographical areas in one country. When entered numbers match the predefined area code rule, the IP phone will automatically add the area code before the numbers when dialing out them. IP phones only support one area code rule.

Procedure

Area code rule can be configured using the configuration files or locally.

<p>Configuration File</p>	<p><y0000000000xx>.cfg</p>	<p>Create the area code rule and specify the maximum and minimum lengths of entered numbers.</p> <p>Parameters:</p> <p>dialplan.area_code.code dialplan.area_code.min_len dialplan.area_code.max_len dialplan.area_code.line_id</p>
<p>Local</p>	<p>Web User Interface</p>	<p>Create the area code rule and specify the maximum and minimum lengths of entered numbers.</p> <p>Navigate to:</p> <p>http://<phoneIPAddress>/servlet?p=settings-areacode&q=load</p>

Details of Configuration Parameters:

Parameters	Permitted Values	Default
dialplan.area_code.code	String within 16 characters	Blank
<p>Description:</p> <p>Configures the area code to be added before the entered numbers when dialing out.</p> <p>Example:</p> <p>dialplan.area_code.code = 0592</p> <p>Note: The length of the entered number must be between the minimum length configured by the parameter “dialplan.area_code.min_len” and the maximum length configured by the parameter “dialplan.area_code.max_len”.</p>		

Parameters	Permitted Values	Default
<p>Web User Interface: Settings->Dial Plan->Area Code->Code</p> <p>Phone User Interface: None</p>		
dialplan.area_code.min_len	Integer from 1 to 15	1
<p>Description: Configures the minimum length of the entered numbers.</p> <p>Web User Interface: Settings->Dial Plan->Area Code->Min Length (1-15)</p> <p>Phone User Interface: None</p>		
dialplan.area_code.max_len	Integer from 1 to 15	15
<p>Description: Configures the maximum length of the entered numbers.</p> <p>Note: The value must be larger than the minimum length.</p> <p>Web User Interface: Settings->Dial Plan->Area Code->Max Length (1-15)</p> <p>Phone User Interface: None</p>		
dialplan.area_code.line_id	Refer to the following content	Blank (for all lines)
<p>Description: Configures the desired line to apply the area code rule. The digit 0 stands for all lines. If it is left blank, the area code rule will apply to all lines on the IP phone.</p> <p>Permitted Values: 0 to 16 (for SIP-T48G/T46G/T29G) 0 to 12 (for SIP-T42G) 0 to 6 (for SIP-T41P/T27P) 0 to 3 (for SIP-T23P/G) 0 to 2 (for SIP-T21(P) E2)</p> <p>Example: dialplan.area_code.line_id = 1</p> <p>Note: Multiple line IDs are separated by commas. It is not applicable to SIP-T19(P) E2</p>		

Parameters	Permitted Values	Default
IP phones. Web User Interface: Settings->Dial Plan->Area Code->Account Phone User Interface: None		

To configure an area code rule via web user interface:

1. Click on **Settings->Dial Plan->Area Code**.
2. Enter the desired values in the **Code**, **Min Length (1-15)** and **Max Length (1-15)** fields.
3. Enter the desired line ID in the **Account** field or leave it blank.

If you leave this field blank or enter 0, the area code rule will apply to all accounts on the IP phone.

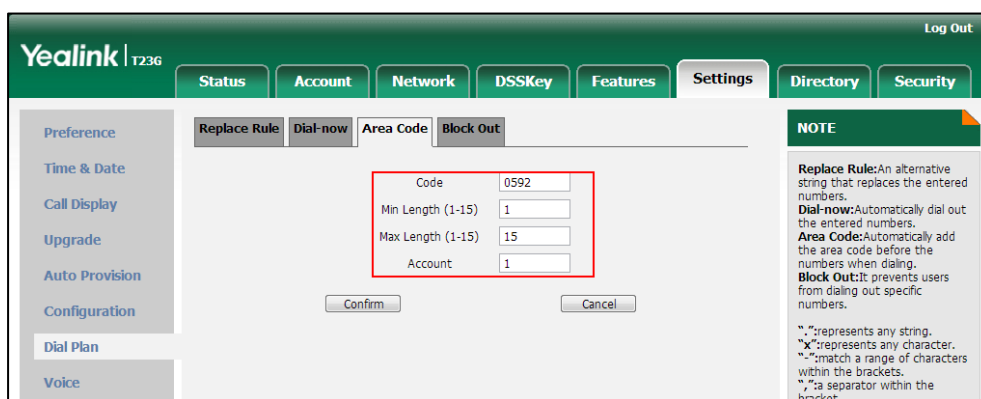

4. Click **Confirm** to accept the change.

Block Out

Block out rule prevents users from dialing out specific numbers. When entered numbers match the predefined block out rule, the LCD screen prompts "Forbidden Number". IP phones support up to 10 block out rules.

Procedure

Block out rule can be created using the configuration files or locally.

Configuration File	<y0000000000xx>.cfg	Create the block out rule for the IP phone. Parameters: dialplan.block_out.number.X
---------------------------	---------------------	--

		dialplan.block_out.line_id.X
Local	Web User Interface	Create the block out rule for the IP phone. Navigate to: http://<phoneIPAddress>/servlet?p=settings-blackout&q=load

Details of Configuration Parameters:

Parameters	Permitted Values	Default
dialplan.block_out.number.X (X ranges from 1 to 10)	String within 32 characters	Blank
<p>Description: Configures the block out numbers.</p> <p>Example: dialplan.block_out.number.1 = 4321 When you dial the number "4321" on your phone, the dialing will fail and the LCD screen will prompt "Forbidden Number".</p> <p>Web User Interface: Settings->Dial Plan->Block Out->BlockOut NumberX</p> <p>Phone User Interface: None</p>		
dialplan.block_out.line_id.X (X ranges from 1 to 10)	Refer to the following content	Blank (for all lines)
<p>Description: Configures the desired line to apply the block out rule. The digit 0 stands for all lines. If it is left blank, the block out rule will apply to all lines on the IP phone.</p> <p>Permitted Values: 0 to 16 (for SIP-T48G/T46G/T29G) 0 to 12 (for SIP-T42G) 0 to 6 (for SIP-T41P/T27P) 0 to 3 (for SIP-T23P/G) 0 to 2 (for SIP-T21(P) E2)</p> <p>Example: dialplan.block_out.line_id.1 = 1,2,3</p> <p>Note: Multiple line IDs are separated by commas. It is not applicable to SIP-T19(P) E2 IP phones.</p>		

Parameters	Permitted Values	Default
Web User Interface: Settings->Dial Plan->Block Out->Account Phone User Interface: None		

To create a block out rule via web user interface:

1. Click on **Settings->Dial Plan->Block Out**.
2. Enter the desired value in the **BlockOut NumberX** field.
3. Enter the desired line ID in the **Account** field or leave it blank.

If you leave this field blank or enter 0, the block out rule will apply to all accounts on the IP phone.

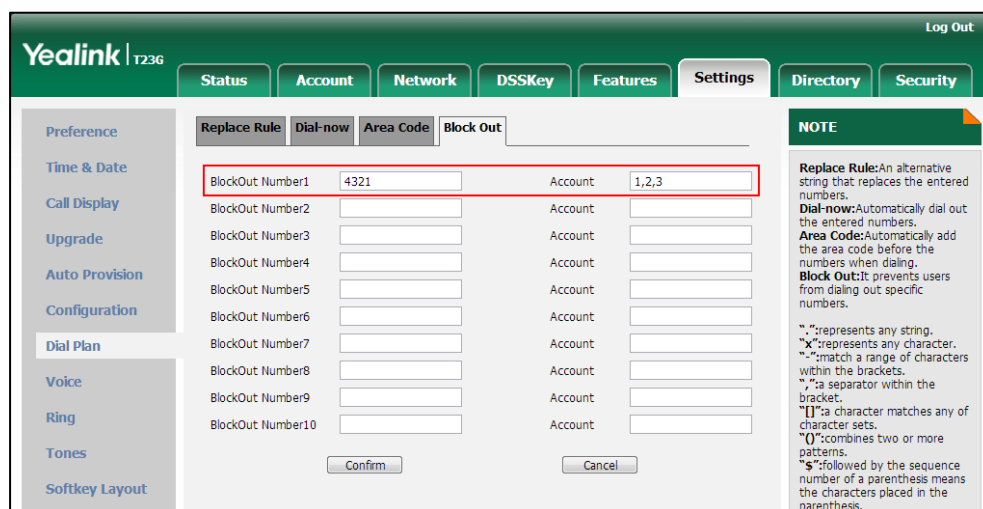

4. Click **Confirm** to add the block out rule.

Hotline

Hotline is a point-to-point communication link in which a call is automatically directed to the preset hotline number. The IP phone automatically dials out the hotline number using the first available line after a specified time interval when off-hook. IP phones only support one hotline number.

Procedure

Hotline can be configured using the configuration files or locally.

Configuration File	<y0000000000xx>.cfg	Configure the hotline number. Parameter: features.hotline_number
---------------------------	---------------------	---

		Specify the time (in seconds) the IP phone waits before automatically dialing out the hotline number. Parameter: features.hotline_delay
Local	Web User Interface	Configure the hotline number. Specify the time (in seconds) the IP phone waits before automatically dial out the hotline number. Navigate to: http://<phoneIPAddress>/servlet?p=features-general&q=load
	Phone User Interface	Configure the hotline number. Specify the time (in seconds) the IP phone waits before automatically dialing out the hotline number.

Details of Configuration Parameters:

Parameter	Permitted Values	Default
features.hotline_number	String within 32 characters	Blank
<p>Description: Configures the hotline number that the IP phone automatically dials out when lifting the handset, pressing the speakerphone key or the line key. Leaving it blank disables hotline feature.</p> <p>Example: features.hotline_number = 1234</p> <p>Web User Interface: Features->General Information->Hotline Number</p> <p>Phone User Interface: Menu->Features->Hot Line->Hot Number</p>		
features.hotline_delay	Integer from 0 to 10	4
<p>Description: Configures the waiting time (in seconds) for the IP phone to automatically dial out</p>		

Parameter	Permitted Values	Default
<p>the hotline number.</p> <p>If it is set to 0 (0s), the IP phone will immediately dial out the preconfigured hotline number when you lift the handset, press the speakerphone key or press the line key.</p> <p>If it is set to a value greater than 0, the IP phone will wait the designated seconds before dialing out the predefined hotline number when you lift the handset, press the speakerphone key or press the line key.</p> <p>Web User Interface:</p> <p>Features->General Information->Hotline Delay(0~10s)</p> <p>Phone User Interface:</p> <p>Menu->Features->Hot Line->Hotline Delay</p>		

To configure hotline via web user interface:

1. Click on **Features->General Information**.
2. Enter the hotline number in the **Hotline Number** field.
3. Enter the delay time in the **Hotline Delay(0~10s)** field.

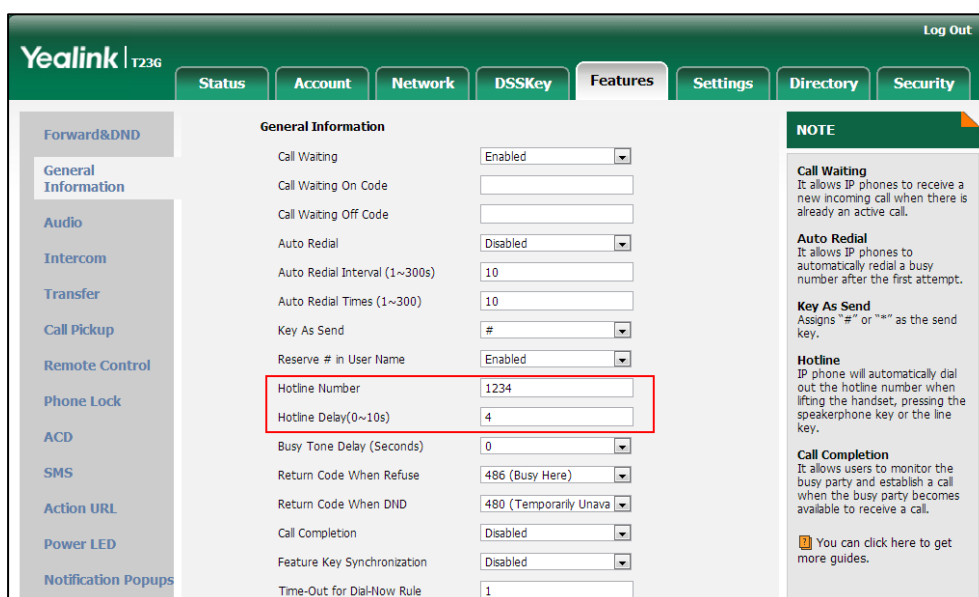

4. Click **Confirm** to accept the change.

To configure hotline via phone user interface:

1. Press **Menu->Features->Hot Line**.
2. Enter the hotline number in the **Hot Number** field.
3. Enter the waiting time (in seconds) in the **Hotline Delay** field.
4. Press the **Save** soft key to accept the change.

Off Hook Hot Line Dialing

For security reasons, IP phones support off hook hot line dialing feature, which allows the phone to first dial out the pre-configured number when the user presses the speakerphone key or desired line key (pressing line key is not applicable to SIP-T19(P) E2 IP phones), dials out a call or goes off hook the phone using the account with this feature enabled. The SIP server may then prompt the user to enter an activation code for call service. Only if the user enters a valid activation code, the IP phone will use this account to dial out a call successfully.

Off hook hot line dialing feature is configurable on a per-line basis and depends on support from a SIP server.

Note

Off hook hot line dialing feature limits the call-out permission of this account and disables the hotline feature. For example, when the phone goes off hook using the account with this feature enabled, the configured hotline number will not be dialed out automatically.

The server actions may vary from different servers.

This feature is also applicable to the IP call and intercom call.

Procedure

Off hook hot line dialing can be configured using the configuration files.

Configuration File	<y0000000000xx>.cfg	<p>Configure off hook hot line dialing feature.</p> <p>Parameter: account.X.auto_dial_enable</p> <p>Specify the number that the phone first dials out.</p> <p>Parameter: account.X.auto_dial_num</p>
---------------------------	---------------------	--

Details of Configuration Parameters:

Parameter	Permitted Values	Default
account.X.auto_dial_enable	0 or 1	0
<p>Description: Enables or disables the IP phone to first dial out a pre-configured number when a user presses the speakerphone key or desired line key, dials out a call or goes off hook the phone using account X.</p> <p>0-Disabled</p>		

Parameter	Permitted Values	Default
<p>1-Enabled</p> <p>If it is set to 1 (Enabled), the phone will first dial out the pre-configured number (configured by the parameter "account.X.auto_dial_num") when a user presses the speakerphone key or desired line key, dials out a call or goes off hook the phone using account X.</p> <p>X ranges from 1 to 16 (for SIP-T48G/T46G/T29G)</p> <p>X ranges from 1 to 12 (for SIP-T42G)</p> <p>X ranges from 1 to 6 (for SIP-T41P/T27P)</p> <p>X ranges from 1 to 3 (for SIP-T23P/G)</p> <p>X ranges from 1 to 2 (for SIP-T21(P) E2)</p> <p>X is equal to 1 (for SIP-T19(P) E2)</p> <p>Note: Pressing line key is not applicable to SIP-T19(P) E2 IP phones.</p> <p>Web User Interface:</p> <p>None</p> <p>Phone User Interface:</p> <p>None</p>		
<p>account.X.auto_dial_num</p>	<p>String within 32 characters</p>	<p>Blank</p>
<p>Description:</p> <p>Configures the number that the IP phone first dials out when a user presses the speakerphone key or desired line key, dials out a call or goes off hook the phone using account X.</p> <p>X ranges from 1 to 16 (for SIP-T48G/T46G/T29G)</p> <p>X ranges from 1 to 12 (for SIP-T42G)</p> <p>X ranges from 1 to 6 (for SIP-T41P/T27P)</p> <p>X ranges from 1 to 3 (for SIP-T23P/G)</p> <p>X ranges from 1 to 2 (for SIP-T21(P) E2)</p> <p>X is equal to 1 (for SIP-T19(P) E2)</p> <p>Note: It works only if the value of the parameter "account.X.auto_dial_enable" is set to 1 (Enabled). Pressing line key is not applicable to SIP-T19(P) E2 IP phones.</p> <p>Web User Interface:</p> <p>None</p> <p>Phone User Interface:</p> <p>None</p>		

Directory

Directory provides easy access to frequently used lists. Users can access lists by pressing the Dir soft key when the IP phone is idle. The lists can be Local Directory, History, Remote Phone Book and LDAP. The desired lists can be added to Directory using a directory file (favorite_setting.xml).

Customizing a Directory Template File

You can ask the distributor or Yealink FAE for directory template. You can also obtain the directory template online:

<http://support.yealink.com/documentFront/forwardToDocumentFrontDisplayPage>. For more information on obtaining the directory template, refer to [Obtaining Configuration Files and Resource Files](#) on page 42.

The following table lists meaning of each variable in the directory template file:

Element	Values	Description
root_favorite_set	no	File root element
item	no	Directory list's root element
id_name	localdirectory history networkcalllog remotedirectory ldap networkdirectory	The existing directory list (For example, "localdirectory" for the local directory list). Note: Do not edit this field.
display_name	Local Directory History Network CallLog Remote Phone Book LDAP Network Directories	The display name of the directory list. Note: We recommend you do not edit this field.
priority	1, 2, 3, 4, 5 and 6. 1 is the highest priority, 6 is the lowest.	The display priority of the directory list.
enable	0/1, 0: Disabled 1: Enabled.	Directory list whether to display on the IP phone LCD screen.

Customizing a directory template:

1. Open the template file using an ASCII editor.
2. For each directory list that you want to configure, edit the corresponding string in the file. For example, configure the local directory list, edit the values within double

quotes in the following strings:

```
<item id_name="localdirectory" display_name="Local Directory" priority="1"
enable="1"/>
```

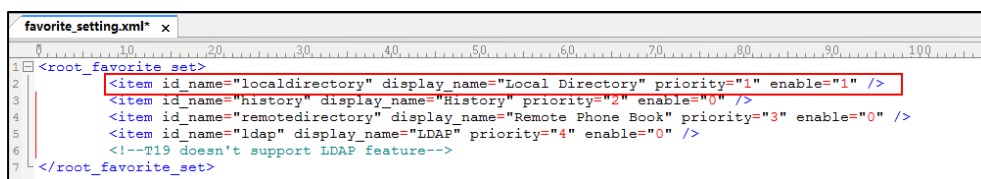

3. Save the change and place this file to the provisioning server (e.g., 192.168.1.20).
4. Specify the access URL of the custom directory template file in the configuration files (e.g., directory_setting.url = http://192.168.1.20/favorite_setting.xml).

Procedure





Directory can be configured using the configuration files or locally.

Configuration File	<y0000000000xx>.cfg	Specify the access URL of the directory template file. Parameter: directory_setting.url
Local	Web User Interface	Configure the Directory. Navigate to: http://<phoneIPAddress>/servlet ?p=contacts-favorite&q=load

Details of the Configuration Parameter:

Parameter	Permitted Values	Default
directory_setting.url	URL within 511 characters	Blank
<p>Description: Configures the access URL of the directory template file.</p> <p>Example: directory_setting.url = http://192.168.1.20/favorite_setting.xml</p> <p>During the auto provisioning process, the IP phone connects to the provisioning server "192.168.1.20", and downloads the directory file "favorite_setting.xml".</p> <p>Web User Interface: Directory->Setting->Directory</p> <p>Phone User Interface: None</p>		

To configure the directory via web user interface:

1. Click on **Directory**->**Setting**.
2. In the **Directory** block, select the desired list from the **Disabled** column and then click  .
The selected list appears in the **Enabled** column.
3. Repeat step 2 to add more lists to the **Enabled** column.
4. To remove a list from the **Enabled** column, select the desired list and then click  .
5. To adjust the display order of list, select the desired list and then click  or  .

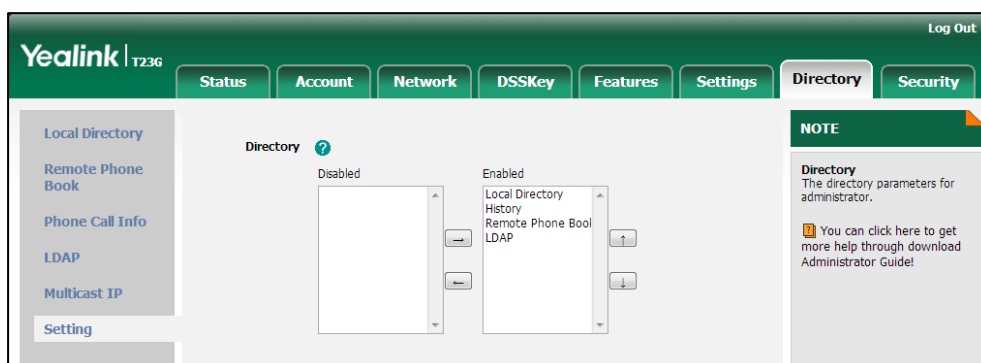

6. Click **Confirm** to accept the change.
The IP phone LCD screen will display the enabled list(s) in the adjusted order.

Search Source in Dialing

Search source list in dialing allows the IP phone to automatically search entries from the search source list based on the entered string, and display results on the pre-dialing screen. The user can select the desired entry to dial out quickly. The search source list can be Local Directory, History, Remote Phone Book and LDAP. The search source list can be configured using a supplied super search template file (super_search.xml).

Customizing a Super Search Template File

You can ask the distributor or Yealink FAE for super search template. You can also obtain the super search template online:

<http://support.yealink.com/documentFront/forwardToDocumentFrontDisplayPage>. For more information on obtaining the super search template, refer to [Obtaining Configuration Files and Resource Files](#) on page 42.

The following table lists meaning of each variable in the super search template file:

Element	Values	Description
root_super_search	No	File root element
Item	No	Super search list's root

Element	Values	Description
		element
id_name	local_directory_search calllog_search remote_directory_search ldap_search Network_directory_search	The directory list (For example, "local_directory_search" for the local directory list). Note: Do not edit this field.
display_name	Local Contacts History Remote Phone Book LDAP Network Directories	The display name of the directory list. Note: We recommend you do not edit this field.
Priority	1, 2, 3, 4 and 5. 1 is the highest priority, 5 is the lowest.	The priority of the search results.
Enable	0/1, 0: Disabled 1: Enabled	Enable or disable the IP phone to search the desired directory list.

Customizing a super search template:

1. Open the template file using an ASCII editor.
2. For each directory list that you want to configure, edit the corresponding string in the file. For example, configure the local directory list, edit the values within double quotes in the following strings:

```
<item id_name="local_directory_search" display_name="Local Contacts"
priority="1" enable="1"/>
```

```

1 <root super_search>
2   <item id_name="local_directory_search" display_name="Local Contacts" priority="1" enable="1" />
3   <item id_name="calllog_search" display_name="History" priority="2" enable="1" />
4   <item id_name="remote_directory_search" display_name="Remote Phone book" priority="3" enable="0" />
5   <item id_name="ldap_search" display_name="LDAP" priority="4" enable="0" />
6 </root_super_search>
7

```

3. Save the change and place this file to the provisioning server (e.g., 192.168.1.20).
4. Specify the access URL of the custom super search template file in the configuration files (e.g., super_search.url = http://192.168.1.20/super_search.xml).

Procedure

Search source list in dialing can be configured using the configuration files or locally.





Configuration File	<y0000000000xx>.cfg	Specify the access URL of the super search template file. Parameter: super_search.url
---------------------------	---------------------	--

Local	Web User Interface	Configure the search source list in dialing. Navigate to: http://<phoneIPAddress>/servlet ?p=contacts-favorite&q=load
--------------	--------------------	---

Details of the Configuration Parameter:

Parameter	Permitted Values	Default
super_search.url	URL within 511 characters	Blank
<p>Description: Configures the access URL of the super search template file.</p> <p>Example: super_search.url = http://192.168.1.20/super_search.xml</p> <p>During the auto provisioning process, the IP phone connects to the provisioning server "192.168.1.20", and downloads the super search template file "super_search.xml".</p> <p>Web User Interface: Directory->Setting->Search Source List In Dialing</p> <p>Phone User Interface: None</p>		

To configure search source list in dialing via web user interface:

1. Click on **Directory->Setting**.
2. In the **Search Source List In Dialing** block, select the desired list from the **Disabled** column and then click  .
The selected list appears in the **Enabled** column.
3. Repeat step 2 to add more lists to the **Enabled** column.
4. To remove a list from the **Enabled** column, select the desired list and then click  .
5. To adjust the display order of search results, select the desired list and then click  or  .

The LCD screen displays the search results in the adjusted order.

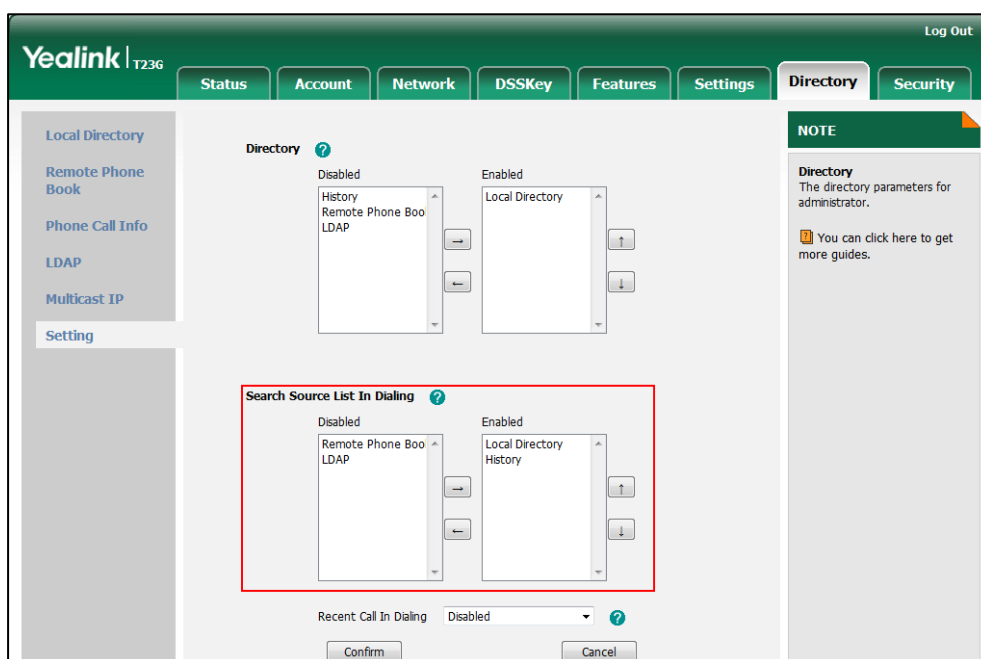

6. Click **Confirm** to accept the change.

Save Call Log

Call log contains call information such as remote party identification, time and date, and call duration. It can be used to redial previous outgoing calls, return incoming calls, and save contact information from call log lists to the contact directory.

IP phones maintain a local call log. Call log consists of four lists: Missed Calls, Placed Calls, Received Calls, and Forwarded Calls. Each call log list supports up to 100 entries. To store call information, you must enable save call log feature in advance. You can access the call history information via web user interface: **Directory->Phone Call Info**.

Procedure

Call log can be configured using the configuration files or locally.

Configuration File	<y0000000000xx>.cfg	Configure call log feature. Parameter: features.save_call_history
Local	Web User Interface	Configure call log feature. Navigate to: http://<phoneIPAddress>/servlet ?p=features-general&q=load
	Phone User Interface	Configure call log feature.

Details of the Configuration Parameter:

Parameter	Permitted Values	Default
features.save_call_history	0 or 1	1

Description:
Enables or disables the IP phone to save the call log.
0-Disabled
1-Enabled
If it is set to 0 (Disabled), the IP phone cannot log the missed calls, placed calls, received calls and the forwarded calls in the call log lists.

Web User Interface:
Features->General Information->Save Call Log

Phone User Interface:
Menu->Features->History Setting

To configure call log feature via web user interface:

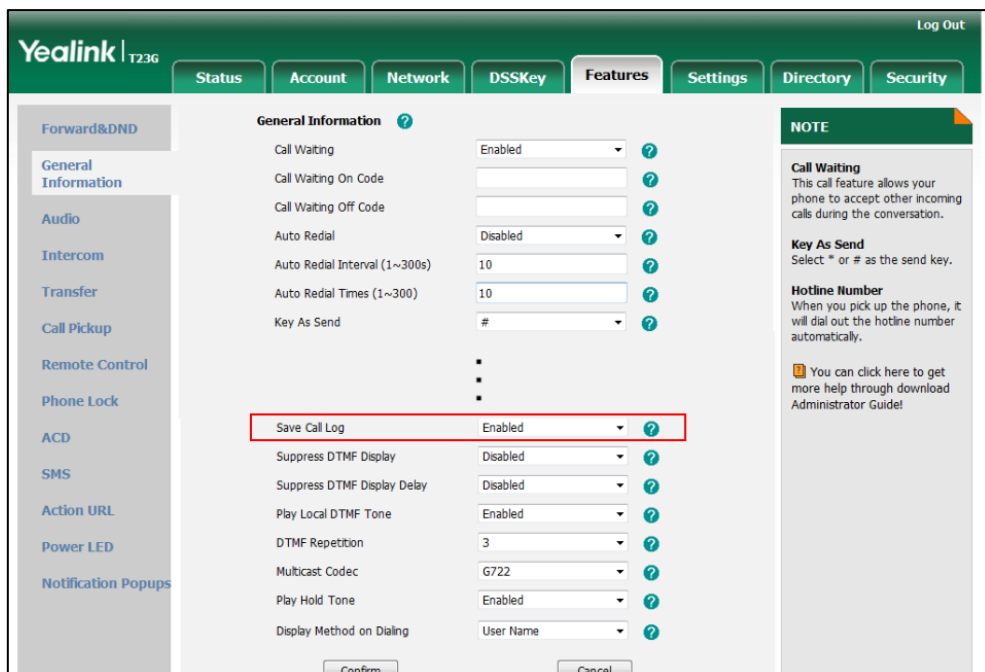

1. Click on **Features->General Information**.
2. Select the desired value from the pull-down list of **Save Call Log**.



3. Click **Confirm** to accept the change.

To configure call log feature via phone user interface:

1. Press **Menu->Features->History Setting**.

2. Press  or  , or the **Switch** soft key to select the desired value from the **History Record** field.
3. Press the **Save** soft key to accept the change.

Call List Show Number

Call list show number allows the IP phone to show the phone number instead of the name in the call log list. To use this feature, make sure the save call log feature is enabled. For more information on save call log, refer to [Save Call Log](#) on page 204.

Procedure

Call list show number can be configured using the configuration files or locally.

Configuration File	<y0000000000xx>.cfg	Configure call list show number. Parameter: features.call_log_show_num
Local	Web User Interface	Configure call list show number. Navigate to: http://<phoneIPAddress>/servlet ?p=features-general&q=load

Details of the Configuration Parameter:

Parameter	Permitted Values	Default
features.call_log_show_num	0 or 1	0
<p>Description: Enables or disables the IP phone to show the other party's phone number instead of the name in the call log lists.</p> <p>0-Disabled 1-Enabled</p> <p>If it is set to 0 (Disabled), the IP phone will show the other party's name in the call log lists.</p> <p>If it is set to 1 (Enabled), the IP phone will show the other party's phone number in the call log lists.</p> <p>Note: It works only if the value of the parameter "features.save_call_history" is set to 1 (Enabled).</p> <p>Web User Interface: Features->General Information->Call List Show Number</p> <p>Phone User Interface:</p>		

Parameter	Permitted Values	Default
None		

To configure call list show number via web user interface:

1. Click on **Features->General Information**.
2. Select the desired value from the pull-down list of **Call List Show Number**.

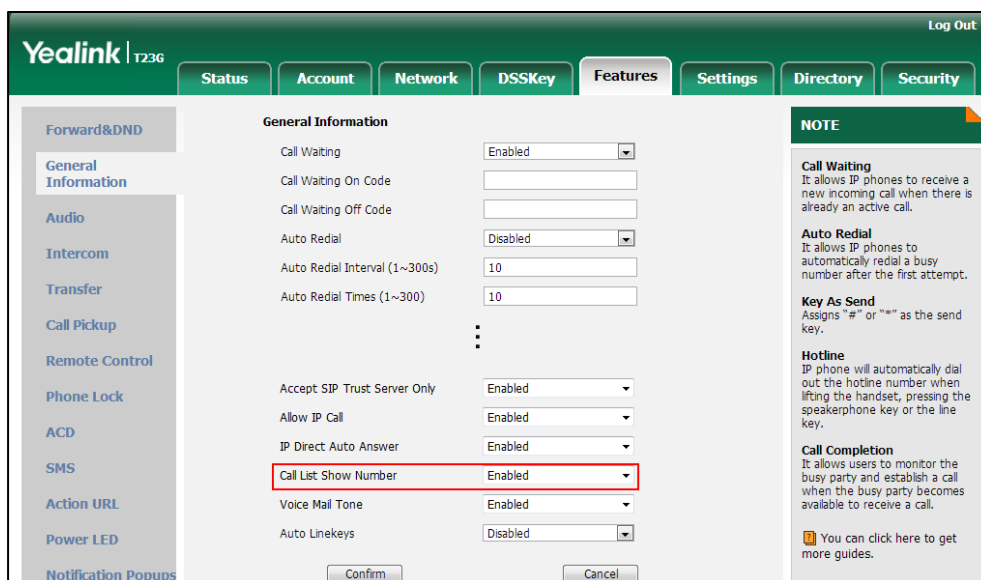

3. Click **Confirm** to accept the change.

Missed Call Log

Missed call log allows the IP phone to display the number of missed calls with an indicator icon on the idle screen, and to log missed calls in the Missed Calls list when the IP phone misses calls. It is configurable on a per-line basis. Once the user accesses the Missed Calls list, the prompt message and indicator icon on the idle screen disappear.

Procedure

Missed call log can be configured using the configuration files or locally.

Configuration File	<MAC>.cfg	Configure missed call log feature. Parameter: account.X.missed_calllog
Local	Web User Interface	Configure missed call log feature. Navigate to: http://<phoneIPAddress>/servlet ?p=account-basic&q=load&acc

		=0
--	--	----

Details of the Configuration Parameter:

Parameter	Permitted Values	Default
account.X.missed_callog	0 or 1	1
<p>Description: Enables or disables the IP phone to indicate and record missed calls for account X. 0-Disabled 1-Enabled If it is set to 0 (Disabled), the IP phone does not display indicator on the idle screen and log the missed call in the Missed Calls list when missed calls. If it is set to 1 (Enabled), the IP phone displays a message on the idle screen and logs the missed call in the Missed Calls list when missed calls. X ranges from 1 to 16 (for SIP-T48G/T46G/T29G) X ranges from 1 to 12 (for SIP-T42G) X ranges from 1 to 6 (for SIP-T41P/T27P) X ranges from 1 to 3 (for SIP-T23P/G) X ranges from 1 to 2 (for SIP-T21(P) E2) X is equal to 1 (for SIP-T19(P) E2) Note: It works only if the value of the parameter "features.save_call_history" is set to 1 (Enabled). Web User Interface: Account->Basic->Missed Call Log Phone User Interface: None</p>		

To configure missed call log via web user interface:

1. Click on **Account->Basic**.
2. Select the desired account from the pull-down list of **Account**.

3. Select the desired value from the pull-down list of **Missed Call Log**.

The screenshot shows the Yealink T23G web interface. The 'Account' tab is selected, and the 'Account 1' configuration page is displayed. The 'Missed Call Log' option is highlighted with a red box, and its value is set to 'Enabled'. Other options include Proxy Require, Local Anonymous, Local Anonymous Rejection, Send Anonymous Code, On Code, Off Code, Send Anonymous Rejection Code, Auto Answer, and Ring Type. A 'NOTE' section on the right provides information about Anonymous Call and Anonymous Call Rejection.

4. Click Confirm to accept the change.

Local Directory

IP phones maintain a local directory. The local directory can store up to 1000 contacts and 48 groups. When adding a contact to the local directory, in addition to name and phone numbers, you can also specify the account, ring tone and group for the contact. Contacts and groups can be added either one by one or in batch using a local contact file. Yealink IP phones support both *.xml and *.csv format contact files, but only support .xml format download for local contact file.

Customizing a Local Contact File

You can add contacts one by one on the IP phone directly. You can also add multiple contacts at a time and/or share contacts between IP phones using the local contact template file. After setup, place the template file to the provisioning server and specify the access URL of the template file in the configuration files. The existing local contacts on the IP phones will be overridden by the downloaded local contacts.

You can ask the distributor or Yealink FAE for local contact template. You can also obtain the local contact template online:

<http://support.yealink.com/documentFront/forwardToDocumentFrontDisplayPage>. For more information on obtaining the local contact file, refer to [Obtaining Configuration Files and Resource Files](#) on page 42.

The following table lists meaning of each variable in the local contact template file:

Element	Values	Description
root_group	no	Group list's root element.
group	no	Group's root element.
display_name	All Contacts Blacklist	An element of group. Group name.
ring	Format of the value: System ring tone: Auto Resource:Silent.wav Resource:Splash.wav Resource:RingN.wav (integer N ranges from 1 to 8) Custom ring tone: Custom:Name.wav	An element of group. Group ring tone.
root_contact	no	Contact list's root element.
contact	no	Contact's root element.
display_name	String	An element of contact. Contact name. Note: This value cannot be blank or duplicated.
office_number	String	Office number of the contact.
mobile_number	String	Mobile number of the contact.
other_number	String	Other number of the contact.
line	-1~15; Multiple line IDs are separated by commas.	The desired line you want to add the contact to. Note: This is not applicable to SIP-T19(P) E2 IP phones.
ring	Format of the value: System ring tone: Auto Resource:Silent.wav Resource:Splash.wav Resource:RingN.wav (integer N ranges from 1 to 8) Custom ring tone: Custom:Name.wav	An element of contact. Contact ring tone.
group_id_name	Valid Value: built-in:	Group name of a contact.

Element	Values	Description
	All Contacts, Blacklist custom: XXX (e.g., Friend)	
default_photo	Format of the value: Resource: avatar name (the built-in avatar) Config: avatar name (the custom avatar)	Contact avatar. Note: It is only applicable to SIP-T48G, SIP-T46G and SIP-T29G IP phones.

The following table lists valid values of line for each phone model.

Phone Model	Values	Description
SIP-T48G/T46G/T29G	-1~15	-1 stands for Auto (the first registered line) 0~15 stand for line1~line16
SIP-T42G	-1~11	-1 stands for Auto (the first registered line) 0~11 stand for line1~line12
SIP-T41P/T27P	-1~5	-1 stands for Auto (the first registered line) 0~5 stand for line1~line6
SIP-T23P/G	-1~2	-1 stands for Auto (the first registered line) 0~2 stand for line1~line3
SIP-T21(P) E2	-1~1	-1 stands for Auto (the first registered line) 0~1 stand for line1~line2

Customizing a Local Contact File (Black-and-white Screen Phones)

The following shows the procedure of customizing a local contact file for SIP-T42G/T41P/T27P/T23P/T23G/T21(P) E2/T19(P) E2 IP phones:

To customize a local contact file:

1. Open the template file using an ASCII editor.
2. For each group that you want to add, add the following string to the file. Each starts on a separate line:

```
<group display_name="" ring=""/>
```
3. For each contact that you want to add, add the following string to the file. Each starts on a separate line:

```
<contact display_name="" office_number="" mobile_number="" other_number="" line="" ring="" group_id_name=""/>
```
4. Specify the values within double quotes.

For example:

```
<group display_name="Friend" ring="Resource:Splash.wav"/>
```

```
<contact display_name="Lily" office_number="1020" mobile_number="1021"
other_number="1112" line="1,2" ring="Resource:Ring1.wav"
group_id_name="Friend"/>
```

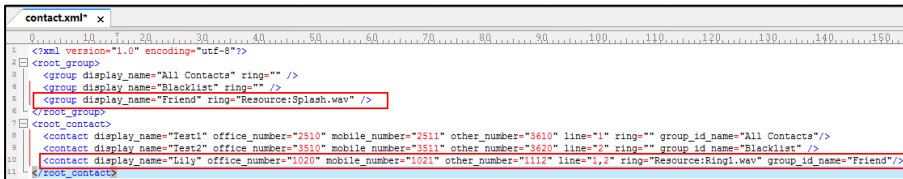

```
contact.xml x
0 10 20 30 40 50 60 70 80 90 100 110 120 130 140 150
1 <?xml version="1.0" encoding="utf-8"?>
2 <root_group>
3   <group display_name="All Contacts" ring="" />
4   <group display_name="Blacklist" ring="" />
5   <group display_name="Friend" ring="Resource:Splash.wav" />
6 </root_group>
7 <root_contact>
8   <contact display_name="Test1" office_number="3510" mobile_number="3511" other_number="3610" line="1" ring="" group_id_name="All Contacts"/>
9   <contact display_name="Test2" office_number="3510" mobile_number="3511" other_number="3620" line="2" ring="" group_id_name="Blacklist"/>
10  <contact display_name="Lily" office_number="1020" mobile_number="1021" other_number="1112" line="1,2" ring="Resource:Ring1.wav" group_id_name="Friend"/>
11 </root_contact>
```

5. Save the change and place this file to the provisioning server.
6. Specify the access URL of the custom local contact template in the configuration files.

For example:

```
local_contact.data.url = tftp://192.168.10.25/contact.xml
```

During the auto provisioning process, the IP phone connects to the provisioning server "192.168.10.25", and downloads the contact file "contact.xml".

Customizing a Local Contact File (Color Screen Phones)

The following shows the procedure of customizing a local contact file for SIP-T48G/T46G/T29G IP phones:

Scenario A - Using the Built-in Avatar for Contact

This scenario is applicable to SIP-T48G/T46G/T29G IP phones.

To customize a local contact file:

1. Open the template file using an ASCII editor.
2. For each group that you want to add, add the following string to the file. Each starts on a separate line:

```
<group display_name="" ring="" />
```

3. For each contact that you want to add, add the following string to the file. Each starts on a separate line:

```
<contact display_name="" office_number="" mobile_number="" other_number=""
line="" ring="" group_id_name="" default_photo="" />
```

4. Specify the values within double quotes.

For example:

```
<group display_name="Friend" ring="Resource:Splash.wav"/>
```

```
<contact display_name="Lily" office_number="1020" mobile_number="1021"
other_number="1112" line="1,2" ring="Resource:Ring1.wav"
group_id_name="Friend" default_photo="Resource:icon_family_b.png"/>
```

```
contact.xml x
1 <?xml version="1.0" encoding="utf-8"?>
2 <root_group>
3   <group display_name="All Contacts" ring="" />
4   <group display_name="Blacklist" ring="" />
5   <group display_name="Friend" ring="Resource:Splash.wav" />
6 </root_group>
7 <root_contact>
8   <contact display_name="Test1" office_number="2510" mobile_number="2511" other_number="3610" line="1" ring="" group_id_name="All Contacts"/>
9   <contact display_name="Test2" office_number="3510" mobile_number="3511" other_number="3620" line="2" ring="" group_id_name="Blacklist" />
10  <contact display_name="Lily" office_number="1020" mobile_number="1021" other_number="1112" line="1,2"
11    ring="Resource:Ring1.wav" group_id_name="Friend" default_photo="Resource:icon_family_b.png"/>
12 </root_contact>
```

5. Save the change and place this file to the provisioning server.
6. Specify the access URL of the custom local contact template in the configuration files.

For example:

```
local_contact.data.url = tftp://192.168.10.25/contact.xml
```

During the auto provisioning process, the IP phone connects to the provisioning server "192.168.10.25", and downloads the contact file "contact.xml".

Scenario B - Using the Custom Avatar for Contact

This scenario is applicable to SIP-T48G/T46G/T29G IP phones.

To specify a custom avatar for a contact, you need to upload the avatar to the provision server in advance. The avatar must be compressed as a tar formatted file.

Preparing the Tar Formatted File

You can package the tar formatted file using the tool 7-Zip or GnuWin32. You can download 7-Zip online: <http://www.7-zip.org/> and GnuWin32 online: <http://gnuwin32.sourceforge.net/packages/gtar.htm>. This section provides you on how to package the tar file using 7-Zip.

To package a tar formatted file using the tool 7-Zip on the Windows platform:

1. Download and install 7-Zip on the local system.
2. Create a folder (e.g., photo) on the local system (e.g., C:\Program Files) and place the files that will be compressed (e.g., cutom1.jpg, cutom2.png) to this folder.
3. Start the 7-Zip file manager application (7zFM.exe).

4. Locate the photo folder from the local system (C:\Program Files\photo\).

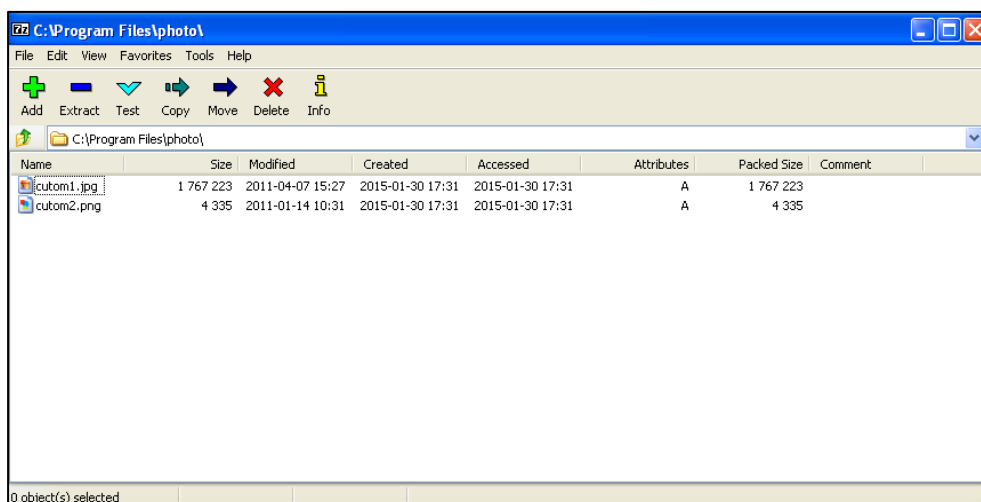

5. Select the desired photos that will be compressed.
6. Click the **Add** button.
7. Select **tar** from the pull-down list of **Archive format**.

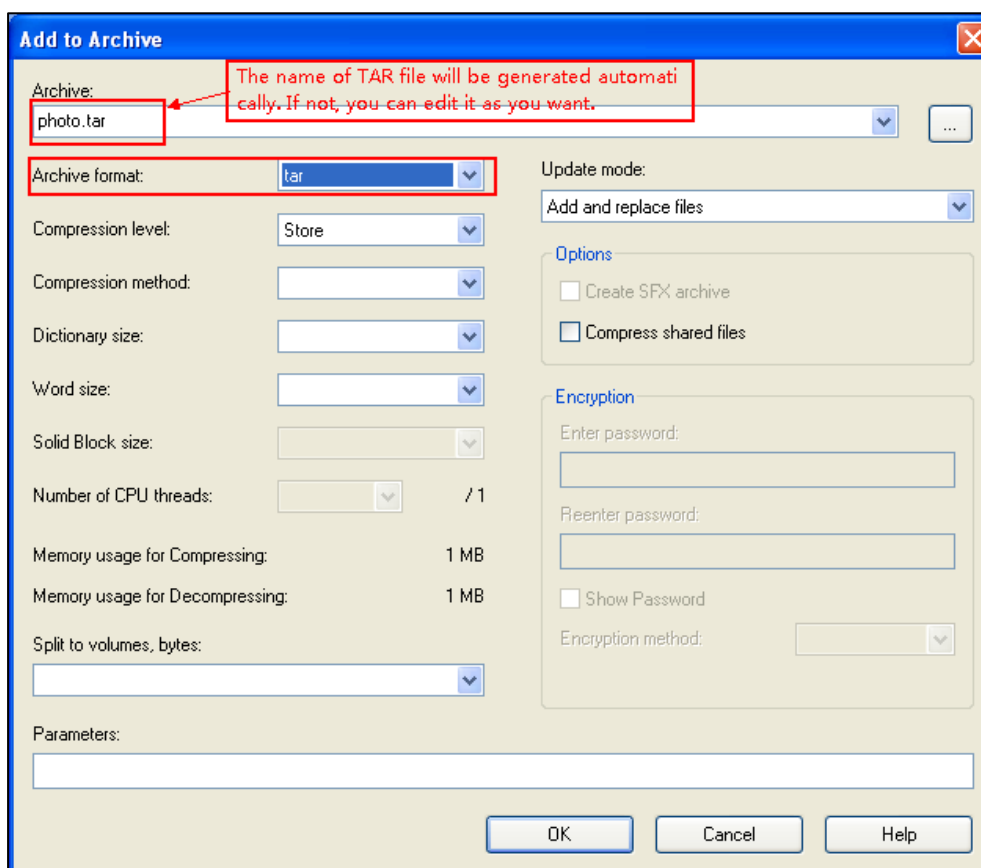

8. Click the **OK** button.
A photo.tar file is generated in the directory C:\Program Files\photo.
9. Place this file to the provisioning server (e.g., 192.168.10.25).

Customizing a Local Contact File

To customize a local contact file:

1. Open the template file using an ASCII editor.
2. For each group that you want to add, add the following string to the file. Each starts on a separate line:

```
<group display_name="" ring=""/>
```

3. For each contact that you want to add, add the following string to the file. Each starts on a separate line:

```
<contact display_name="" office_number="" mobile_number="" other_number=""
line="" ring="" group_id_name="" default_photo=""/>
```

4. Specify the values within double quotes.

For example:

```
<group display_name="Friend" ring="Resource:Splash.wav"/>
<contact display_name="Lily" office_number="1020" mobile_number="1021"
other_number="1112" line="1,2" ring="Resource:Ring1.wav"
group_id_name="Friend" default_photo="Config:cutom1.jpg"/>
```

```
contact.xml x
1 <?xml version="1.0" encoding="utf-8"?>
2 <root_group>
3   <group display_name="All Contacts" ring="" />
4   <group display_name="Blacklist" ring="" />
5   <group display_name="Friend" ring="Resource:Splash.wav" />
6 </root_group>
7 <root_contact>
8   <contact display_name="Test1" office_number="2510" mobile_number="2511" other_number="3610" line="1" ring="" group_id_name="All Contacts"/>
9   <contact display_name="Test2" office_number="3510" mobile_number="3511" other_number="3620" line="2" ring="" group_id_name="Blacklist" />
10  <contact display_name="Lily" office_number="1020" mobile_number="1021" other_number="1112" line="1,2"
11    ring="Resource:Ring1.wav" group_id_name="Friend" default_photo="Config:cutom1.jpg"/>
12 </root_contact>
```

5. Save the change and place this file to the provisioning server.
6. Specify the access URL of the custom local contact template in the configuration files.

There are two methods to specify a custom avatar for a contact:

Method 1:

```
local_contact.data.url = tftp://192.168.10.25/contact.xml
```

```
local_contact.image.url = tftp://192.168.10.25/photo.tar
```

For more information on generating a contact avatar file "photo.tar", refer to [Preparing the Tar Formatted File](#) on page 213.

During the auto provisioning process, the IP phone connects to the provisioning server "192.168.1.100", and downloads the contact file "contact.xml" and avatar file "photo.tar".

Method 2:

If the local contact file (contact.xml) and custom avatars (photo.tar) are compressed as a tar formatted file (e.g., Contact.tar), you can only configure the following parameter to upload contacts and avatars:

```
local_contact.data_photo_tar.url = tftp://192.168.10.25/Contact.tar
```

For more information on generating “photo.tar” and “Contact.tar”, refer to [Preparing the Tar Formatted File](#) on page 213.

During the auto provisioning process, the IP phone connects to the provisioning server “192.168.10.25”, and downloads the file “Contact.tar”.

Scenario C - Using the Custom Avatar and Custom Icon for Contact

This scenario is only applicable to SIP-T48G IP phones.

To specify a custom avatar and icon for a contact, you need to upload the avatar and icon to the provision server in advance. The avatar and icon must be compressed as a tar formatted file respectively (e.g., photo1.tar and photo2.tar). For more information on generating a tar formatted file, refer to [Preparing the Tar Formatted File](#) on page 213.

Note The custom avatar and custom icon can be different, but make sure the icon name is the same as avatar name (e.g., cutom1.jpg, cutom2.png).

To customize a local contact file:

1. Open the template file using an ASCII editor.
2. For each group that you want to add, add the following string to the file. Each starts on a separate line:

```
<group display_name="" ring=""/>
```

3. For each contact that you want to add, add the following string to the file. Each starts on a separate line:

```
<contact display_name="" office_number="" mobile_number="" other_number="" line="" ring="" group_id_name="" default_photo=""/>
```

4. Specify the values within double quotes.

For example:

```
<group display_name="Friend" ring="Resource:Splash.wav"/>
<contact display_name="Lily" office_number="1020" mobile_number="1021"
other_number="1112" line="1,2" ring="Resource:Ring1.wav"
group_id_name="Friend" default_photo="Config:cutom1.jpg"/>
```

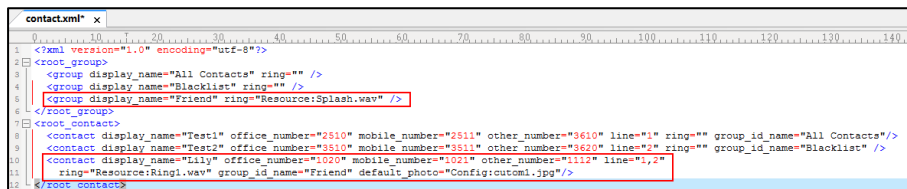

5. Save the change and place this file to the provisioning server.
6. Specify the access URL of the custom local contact template file in the configuration files.

local_contact.image.url = tftp://192.168.10.25/photo1.tar

local_contact.data.url = tftp://192.168.10.25/contact.xml

local_contact.icon.url = tftp://192.168.10.25/photo2.tar

During the auto provisioning process, the IP phone connects to the provisioning server “192.168.10.25”, and downloads the avatar file “photo1.tar”, icon file “photo2.tar” and the contact file “contact.xml”.

Procedure

Local directory be configured using the configuration files or locally.

<p>Configuration File</p>	<p><y0000000000xx>.cfg</p>	<p>Specify the access URL of the local contact file (*.xml).</p> <p>Parameter: local_contact.data.url</p> <p>Specify the access URL of a TAR contact avatar file.</p> <p>Parameter: local_contact.image.url</p> <p>Specify the access URL of the compressed TAR file consisting of the avatars TAR file and contact XML file.</p> <p>Parameter: local_contact.data_photo_tar.url</p> <p>Specify the access URL of a TAR contact icon file.</p> <p>Parameter: local_contact.icon.url</p>
<p>Local</p>	<p>Web User Interface</p>	<p>Add a new group and a contact to the local directory.</p> <p>To import or export the local contact file.</p> <p>Navigate to: http://<phoneIPAddress>/servlet?p=contactsbasic&q=load&num=1&group=</p>
	<p>Phone User Interface</p>	<p>Add a new group and a contact to the local directory.</p>

Details of the Configuration Parameter:

Parameter	Permitted Values	Default
local_contact.data.url	URL within 511 characters	Blank
<p>Description: Configures the access URL of the local contact file (*.xml).</p> <p>Example: local_contact.data.url = http://192.168.10.25/contact.xml</p> <p>Web User Interface: Directory->Local Directory->Import Local Directory File</p> <p>Phone User Interface: None</p>		
local_contact.image.url	URL within 511 characters	Blank
<p>Description: Configures the access URL of a TAR contact avatar file. The format of the contact avatar must be *.png, *.jpg, *.bmp. The contact avatar file should be compressed as a TAR file in advance and then place it to the provisioning server.</p> <p>Example: local_contact.image.url = tftp://192.168.10.25/photo.tar</p> <p>Note: It is only applicable to SIP-T48G/T46G/T29G IP phones.</p> <p>Web User Interface: None</p> <p>Phone User Interface: None</p>		
local_contact.data_photo_tar.url	URL within 511 characters	Blank
<p>Description: Configures the access URL of the compressed TAR file consisting of the avatars TAR file and contact XML file. All avatars needed for contacts should be compressed as a TAR file in advance.</p> <p>Example: local_contact.data_photo_tar.url = tftp://192.168.10.25/Contact.tar</p> <p>Note: It is only applicable to SIP-T48G/T46G/T29G IP phones.</p> <p>Web User Interface:</p>		

Parameter	Permitted Values	Default
Phone User Interface: None		
local_contact.icon.url	URL within 511 characters	Blank
Description: Configures the access URL of a TAR contact icon file. The format of the contact icon must be *.png, *.jpg, *.bmp. The contact icon file should be compressed as a TAR file in advance and then place it to the provisioning server. Example: local_contact.icon.url = tftp://192.168.10.25/photo2.tar Note: It is only applicable to SIP-T48G IP phones. Web User Interface: None Phone User Interface: None		

To add a group to the local directory via web user interface:

1. Click on **Directory->Local Directory**.
2. In the **Group Setting** block, enter the desired group name in the **Group** field.
3. Select the desired ring tone from the pull-down list of **Ring**.

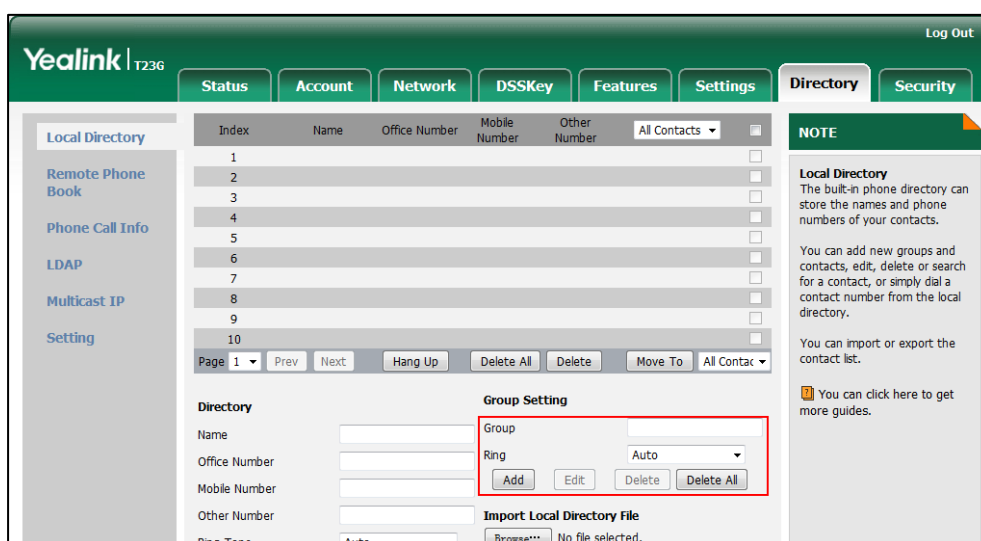

4. Click **Add** to add the group.

To add a contact to the local directory via web user interface:

1. Click on **Directory->Local Directory**.
2. In the **Directory** block, enter the name and the office, mobile or other numbers in the corresponding fields.
3. Select the desired ring tone from the pull-down list of **Ring Tone**.
4. Select the desired group from the pull-down list of **Group**.
5. Select the desired account from the pull-down list of **Account**.

If **Auto** is selected, the IP phone will use the default account when placing calls to the contact from the local directory.

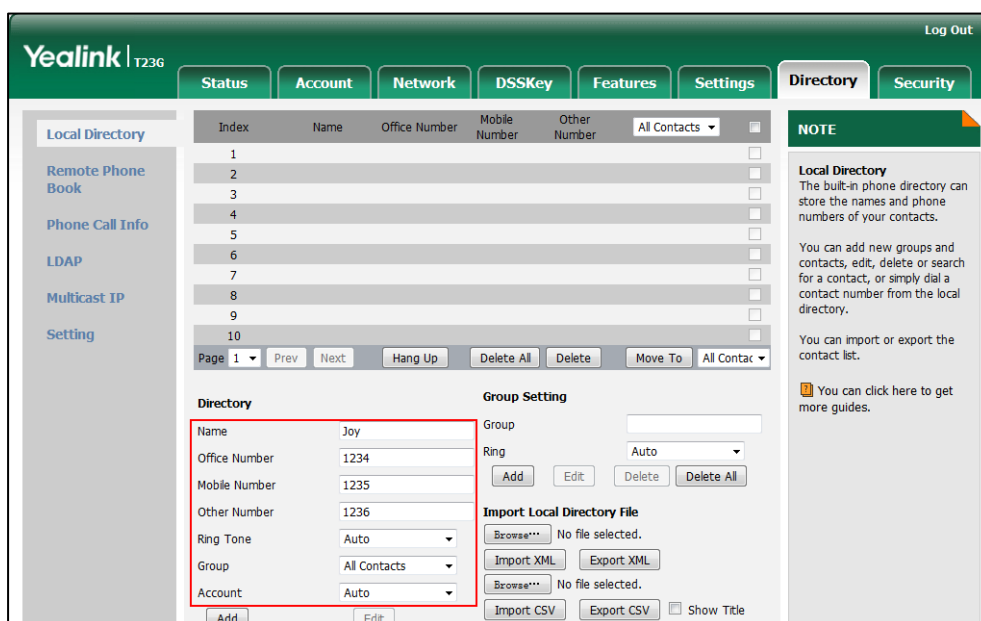

6. Click **Add** to add the contact.

To add a group to the local directory via phone user interface:

1. Press **Menu->Directory->Local Directory**.
2. Press the **AddGr** soft key.
3. Enter the desired group name in the **Name** field.
4. Press **◀** or **▶**, or the **Switch** soft key to select the desired group ring tone from the **Ring** field.
5. Press the **Add** soft key to accept the change.

To import an XML contact list file via web user interface:

1. Click on **Directory->Local Directory**.

- Click **Browse** to locate a contact list file (the file format must be *.xml) from your local system.

The screenshot shows the Yealink T236 web interface. The top navigation bar includes 'Status', 'Account', 'Network', 'DSSKey', 'Features', 'Settings', 'Directory', and 'Security'. The 'Directory' section is active, displaying a table of contacts with columns for Index, Name, Office Number, Mobile Number, and Other Number. Below the table, there are 'Import Local Directory File' and 'Import CSV' sections, each with a 'Browse...' button and an 'Import' button. The 'Import Local Directory File' section is highlighted with a red box. A 'NOTE' box on the right provides instructions on how to use the local directory.

- Click **Import XML** to import the contact list.
The web user interface prompts "The original contact will be covered, Continue?".
- Click **OK** to complete importing the contact list.

To import a CSV contact list file via web user interface:

- Click on **Directory->Local Directory**.
- Click **Browse** to locate a contact list file (the file format must be *.csv) from your local system.
- (Optional.) Check the **Show Title** checkbox.
It will prevent importing the title of the contact information which is located in the first line of the CSV file.
- Click **Import CSV** to import the contact list.
- (Optional.) Mark the **On** radio box in the **Delete Old Contacts** field.
It will delete all existing contacts while importing the contact list.
- Select the contact information you want to import into the local directory from the pull down list of **Index**.

At least one item should be selected to be imported into the local directory.

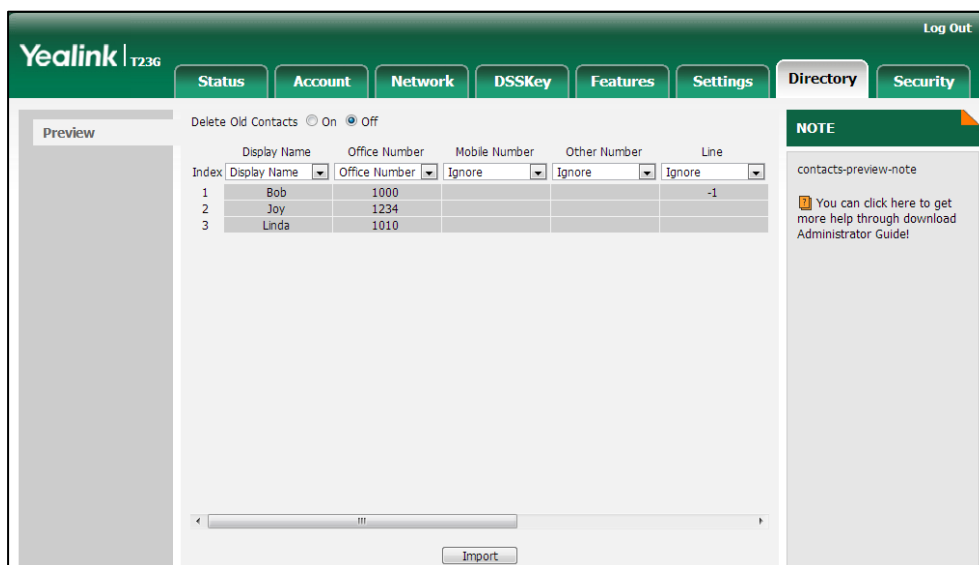

7. Click **Import** to complete importing the contact list.

To export a contact list via web user interface:

1. Click on **Directory->Local Directory**.
2. Click **Export XML** (or **Export CSV**).
3. Click **Save** to save the contact list to your local system.

To add a contact to the local directory via phone user interface:

1. Press **Menu->Directory->Local Directory**.
2. Select the desired contact group and then press the **Enter** soft key.
3. Press the **Add** soft key.
4. Enter the name and the office, mobile or other numbers in the corresponding fields.
5. Press ◀ or ▶, or the **Switch** soft key to select the desired account from the **Account** field.

If **Auto** is selected, the IP phone will use the default account when placing calls to the contact from the local directory.

6. Press ◀ or ▶, or the **Switch** soft key to select the desired ring tone from the **Ring** field.
7. Press the **Save** soft key to accept the change.

Live Dialpad

Live dialpad allows IP phones to automatically dial out the entered phone number after a specified period of time.

Procedure

Live dialpad can be configured using the configuration files or locally.

Configuration File	<y0000000000xx>.cfg	Configure live dialpad. Parameters: phone_setting.predial_autodial phone_setting.inter_digit_time
Local	Web User Interface	Configure live dialpad. Navigate to: http://<phoneIPAddress>/servlet ?p=settings-preference&q=load

Details of Configuration Parameters:

Parameters	Permitted Values	Default
phone_setting.predial_autodial	0 or 1	0
<p>Description: Enables or disables the live dialpad feature. 0-Disabled 1-Enabled If it is set to 1 (Enabled), the IP phone will automatically dial out the entered phone number on the dialing screen without pressing a send key.</p> <p>Web User Interface: Settings->Preference->Live Dialpad</p> <p>Phone User Interface: None</p>		
phone_setting.inter_digit_time	Integer from 1 to 14	4
<p>Description: Configures the delay time (in seconds) for the IP phone to automatically dial out the entered digits without pressing a send key.</p> <p>Note: It works only if the value of the parameter "phone_setting.predial_autodial" is set to 1 (Enabled).</p> <p>Web User Interface: Settings->Preference->Inter Digit Time(1~14s)</p> <p>Phone User Interface: None</p>		

To configure live dialpad via web user interface:

1. Click on **Settings->Preference**.
2. Select the desired value from the pull-down list of **Live Dialpad**.
3. Enter the desired delay time in the **Inter Digit Time(1~14s)** field.

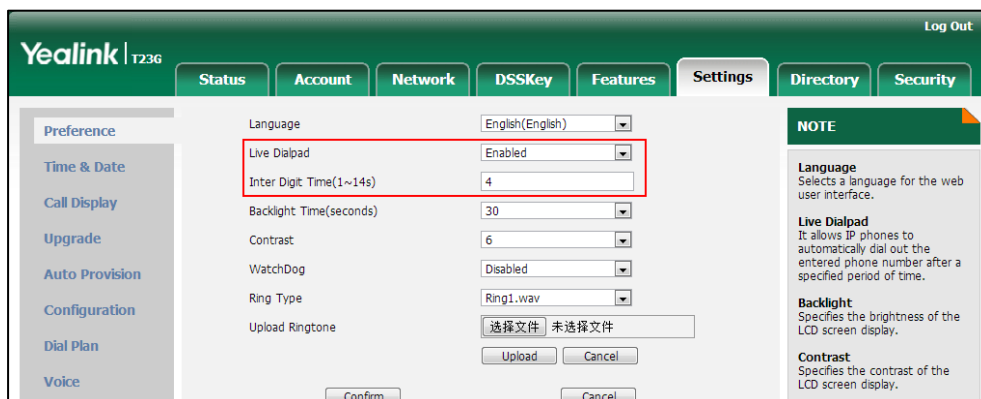

4. Click **Confirm** to accept the change.

Call Waiting

Call waiting allows IP phones to receive a new incoming call when there is already an active call. The new incoming call is presented to the user visually on the LCD screen. Call waiting tone allows the IP phone to play a short tone, to remind the user audibly of a new incoming call during conversation. Call waiting tone works only if call waiting is enabled.

The call waiting on code and call waiting off code configured on IP phones are used to activate/deactivate the server-side call waiting feature. They may vary on different servers.

Procedure

Call waiting and call waiting tone can be configured using the configuration files or locally.

Configuration File	<y0000000000xx>.cfg	Configure call waiting and call waiting tone. Parameters: call_waiting.enable call_waiting.tone call_waiting.on_code call_waiting.off_code
Local	Web User Interface	Configure call waiting. Navigate to: http://<phoneIPAddress>/servlet

		?p=features-general&q=load Configure call waiting tone. Navigate to: http://<phoneIPAddress>/servlet ?p=features-audio&q=load
	Phone User Interface	Configure call waiting and call waiting tone.

Details of Configuration Parameters:

Parameters	Permitted Values	Default
call_waiting.enable	0 or 1	1
<p>Description: Enables or disables call waiting feature.</p> <p>0-Disabled 1-Enabled</p> <p>If it is set to 0 (Disabled), a new incoming call is automatically rejected by the IP phone with a busy message while during a call.</p> <p>If it is set to 1 (Enabled), the LCD screen will present a new incoming call while during a call.</p> <p>Web User Interface: Features->General Information->Call Waiting</p> <p>Phone User Interface: Menu->Features->Call Waiting->Call Waiting</p>		
call_waiting.tone	0 or 1	1
<p>Description: Enables or disables the IP phone to play the call waiting tone when the IP phone receives an incoming call during a call.</p> <p>0-Disabled 1-Enabled</p> <p>If it is set to 1 (Enabled), the IP phone will perform an audible indicator when receiving a new incoming call during a call.</p> <p>Note: It works only if the value of the parameter "call_waiting.enable" is set to 1 (Enabled).</p> <p>Web User Interface: Features->Audio->Call Waiting Tone</p>		

Parameters	Permitted Values	Default
Phone User Interface: Menu->Features->Call Waiting->Play Tone		
call_waiting.on_code	String within 32 characters	Blank
Description: Configures the call waiting on code to activate the server-side call waiting feature. The IP phone will send the call waiting on code to the server when you activate call waiting feature on the IP phone. Example: call_waiting.on_code = *71 Web User Interface: Features->General Information->Call Waiting On Code Phone User Interface: Menu->Features->Call Waiting->On Code		
call_waiting.off_code	String within 32 characters	Blank
Description: Configures the call waiting off code to deactivate the server-side call waiting feature. The IP phone will send the call waiting off code to the server when you deactivate call waiting feature on the IP phone. Example: call_waiting.off_code = *72 Web User Interface: Features->General Information->Call Waiting Off Code Phone User Interface: Menu->Features->Call Waiting->Off Code		

To configure call waiting via web user interface:

1. Click on **Features->General Information**.
2. Select the desired value from the pull-down list of **Call Waiting**.
3. (Optional.) Enter the call waiting on code in the **Call Waiting On Code** field.

- (Optional.) Enter the call waiting off code in the **Call Waiting Off Code** field.

The screenshot shows the Yealink T236 web interface. The 'Features' tab is selected, and the 'General Information' section is active. The 'Call Waiting' dropdown menu is set to 'Enabled'. Below it, the 'Call Waiting On Code' is set to '*71' and the 'Call Waiting Off Code' is set to '*72'. A 'NOTE' box on the right side of the page provides details about the 'Call Waiting' feature, stating it allows IP phones to receive a new incoming call when there is already an active call. Other settings like 'Auto Redial' (Disabled), 'Auto Redial Interval' (10), 'Auto Redial Times' (10), and 'Key As Send' (#) are also visible.

- Click **Confirm** to accept the change.

To configure call waiting tone via web user interface:

- Click on **Features->Audio**.
- Select the desired value from the pull-down list of **Call Waiting Tone**.

The screenshot shows the Yealink T236 web interface with the 'Features' tab selected and the 'Audio Settings' section active. The 'Call Waiting Tone' dropdown menu is set to 'Enabled'. Other settings include 'Key Tone' (Enabled), 'Send Tone' (Enabled), 'Redial Tone' (empty), and 'Ringer Device for Headset' (Use Speaker). A 'NOTE' box on the right side of the page explains the 'Tone' feature, which enables or disables the call waiting tone, key tone, and send tone. It also explains the 'Redial Tone' feature, which allows IP phones to continue to play the dial tone after inputting preset numbers on the pre-dialing screen. A 'Ringer Device for Headset' note explains that it selects either or both speaker and headset ringer devices. A link is provided to get more guides.

- Click **Confirm** to accept the change.

To configure call waiting and call waiting tone via phone user interface:

- Press **Menu->Features->Call Waiting**.
- Press **◀** or **▶**, or the **Switch** soft key to select the desired value from the **Call Waiting** field.
- Press **◀** or **▶**, or the **Switch** soft key to select the desired value from the **Play Tone** field.
- (Optional.) Enter the call waiting on code in the **On Code** field.
- (Optional.) Enter the call waiting off code in the **Off Code** field.
- Press the **Save** soft key to accept the change.

Redial Tone

Redial tone allows IP phones to continue to play the dial tone after inputting the preset numbers on the pre-dialing screen.

Procedure

Redial tone can be configured using the configuration files or locally.

Configuration File	<y0000000000xx>.cfg	Configure redial tone feature. Parameters: features.redial_tone
Local	Web User Interface	Configure redial tone feature. Navigate to: http://<phoneIPAddress>/servlet ?p=features-audio&q=load

Details of Configuration Parameters:

Parameters	Permitted Values	Default
features.redial_tone	Integer within 6 digits	Blank
<p>Description: Configures the IP phone to continue to play the dial tone after inputting the preset numbers on the pre-dialing screen.</p> <p>Example: features.redial_tone = 125 The IP phone will continue to play the dial tone after inputting "125" on the pre-dialing screen. If it is left blank, the IP phone will not play the dial tone after inputting numbers on the pre-dialing screen.</p> <p>Web User Interface: Features->Audio->Redial Tone</p> <p>Phone User Interface: None</p>		

To configure redial tone via web user interface:

1. Click on **Features->Audio**.

2. Enter the desired value in the **Redial Tone** field.

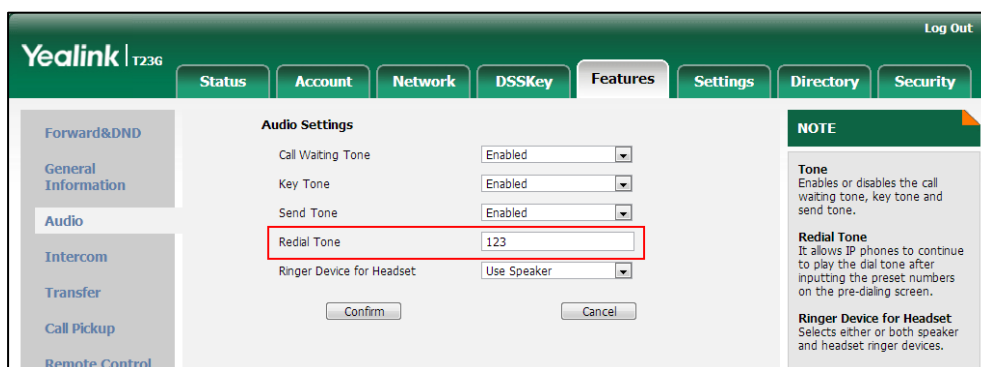

3. Click **Confirm** to accept the change.

Ringer Device for Headset

The IP phones support either or both speaker and headset ringer devices. If the ringer device is set to Headset or Headset&Speaker, the headset should be connected to the IP phone and the headset mode also should be activated in advance. You can press the HEADSET key to activate the headset mode.

Procedure

Ringer device for headset can be configured using the configuration files or locally.

Configuration File	<y0000000000xx>.cfg	Configure the ringer device for the IP phone. Parameters: features.ringer_device.is_use_headset
Local	Web User Interface	Configure the ringer device for the IP phone. Navigate to: http://<phoneIPAddress>/servlet?p=features-audio&q=load

Details of Configuration Parameters:

Parameters	Permitted Values	Default
features.ringer_device.is_use_headset	0, 1 or 2	0
Description: Configures the ringer device for the IP phone.		

Parameters	Permitted Values	Default
<p>0-Use Speaker</p> <p>1-Use Headset</p> <p>2-Use Headset & Speaker</p> <p>If the ringer device is set to Headset or Headset&Speaker, the headset should be connected to the IP phone and the headset mode also should be activated in advance.</p> <p>Web User Interface:</p> <p>Features->Audio->Ringer Device for Headset</p> <p>Phone User Interface:</p> <p>None</p>		

To configure ringer device for headset via web user interface:

1. Click on **Features->Audio**.
2. Select the desired value from the pull-down list of **Ringer Device for Headset**.

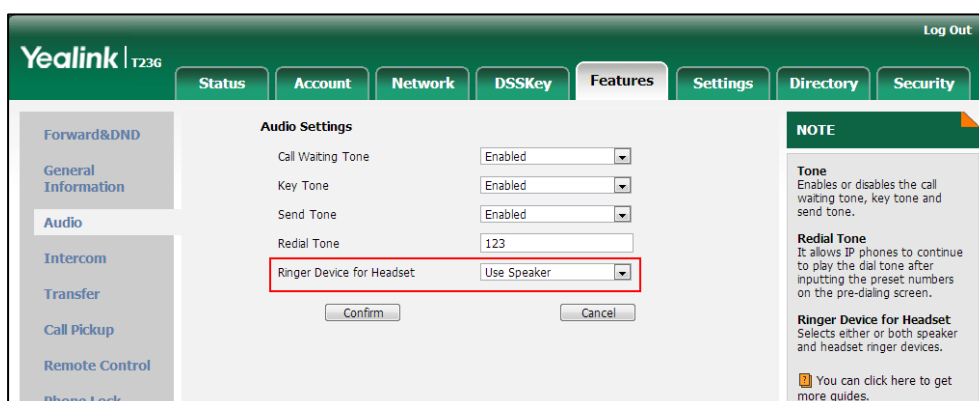

3. Click **Confirm** to accept the change.

Auto Redial

Auto redial allows IP phones to redial a busy number after the first attempt. Both the number of attempts and waiting time between redials are configurable.

Procedure

Auto redial can be configured using the configuration files or locally.

Configuration File	<y0000000000xx>.cfg	<p>Configure auto redial feature.</p> <p>Parameters:</p> <p>auto_redial.enable</p> <p>auto_redial.interval</p>
---------------------------	---------------------	---

		auto_redial.times
Local	Web User Interface	Configure auto redial feature. Navigate to: http://<phoneIPAddress>/servlet ?p=features-general&q=load
	Phone User Interface	Configure auto redial feature.

Details of Configuration Parameters:

Parameters	Permitted Values	Default
auto_redial.enable	0 or 1	0
<p>Description: Enables or disables the IP phone to automatically redial the dialed number when the callee is temporarily unavailable.</p> <p>0-Disabled 1-Enabled</p> <p>If it is set to 1 (Enabled), the IP phone will dial the previous dialed out number automatically when the dialed number is temporarily unavailable.</p> <p>Web User Interface: Features->General Information->Auto Redial</p> <p>Phone User Interface: Menu->Features->Auto Redial->Auto Redial</p>		
auto_redial.interval	Integer from 1 to 300	10
<p>Description: Configures the interval (in seconds) for the IP phone to wait between redials. The IP phone redials the dialed number at regular intervals till the callee answers the call.</p> <p>Web User Interface: Features->General Information->Auto Redial Interval (1~300s)</p> <p>Phone User Interface: Menu->Features->Auto Redial->Redial Interval</p>		
auto_redial.times	Integer from 1 to 300	10
<p>Description: Configures the auto redial times when the callee is temporarily unavailable.</p>		

Parameters	Permitted Values	Default
<p>The IP phone tries to redial the dialed number as many times as configured till the callee answers the call.</p> <p>Web User Interface: Features->General Information->Auto Redial Times (1~300)</p> <p>Phone User Interface: Menu->Features->Auto Redial->Redial Times</p>		

To configure auto redial via web user interface:

1. Click on **Features->General Information**.
2. Select the desired value from the pull-down list of **Auto Redial**.
3. Enter the waiting time in the **Auto Redial Interval (1~300s)** field.
The default waiting time is 10.
4. Enter the desired times in the **Auto Redial Times (1~300)** field.
The default value is 10.

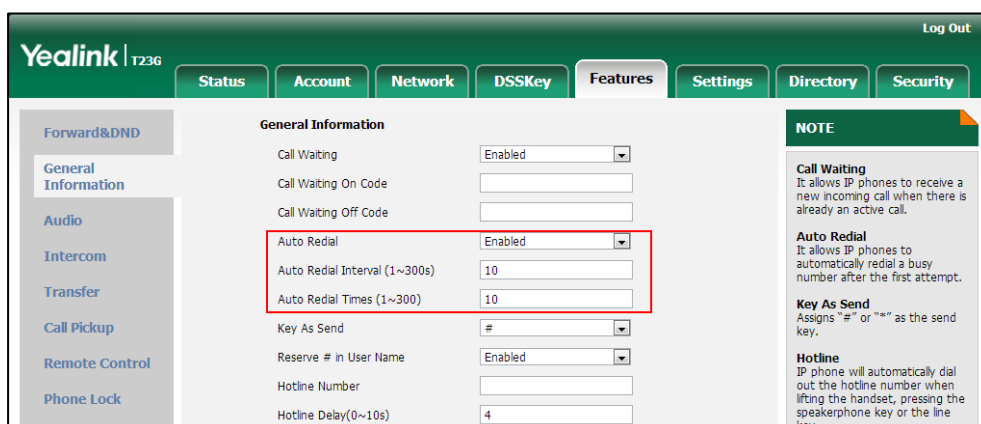

5. Click **Confirm** to accept the change.

To configure auto redial via phone user interface:

1. Press **Menu->Features->Auto Redial**.
2. Press **◀** or **▶**, or the **Switch** soft key to select the desired value from the **Auto Redial** field.
3. Enter the waiting time (in seconds) in the **Redial Interval** field.
4. Enter the desired times in the **Redial Times** field.
5. Press the **Save** soft key to accept the change.

Auto Answer

Auto answer allows IP phones to automatically answer an incoming call. IP phones will

not automatically answer the incoming call during a call even if auto answer is enabled. Auto answer is configurable on a per-line basis. Auto-Answer delay defines a period of delay time before the IP phone automatically answers incoming calls.

Auto Answer Tone

Auto answer tone allows the IP phone to play a tone when an incoming call is automatically answered.

Note

Auto answer is not applicable to automatically answer an IP address call. Automatically answering an IP address call works only if IP direct auto answer feature is enabled. For more information, refer to [IP Direct Auto Answer](#) on page 237.

Procedure

Auto answer can be configured using the configuration files or locally.

Configuration File	<MAC>.cfg	Configure auto answer. Parameter: account.X.auto_answer
	<y0000000000xx>.cfg	Specify a period of delay time for auto answer. Parameter: features.auto_answer_delay Configure auto answer tone. Parameter: features.auto_answer_tone.enable
Local	Web User Interface	Configure auto answer. Navigate to: http://<phoneIPAddress>/servlet?p=account-basic&q=load&acc=0 Specify a period of delay time for auto answer. Configure auto answer tone. Navigate to: http://<phoneIPAddress>servlet?p=features-general&q=load
	Phone User Interface	Configure auto answer.

Details of Configuration Parameters:

Parameters	Permitted Values	Default
account.X.auto_answer	0 or 1	0
<p>Description: Enables or disables auto answer feature for account X. 0-Disabled 1-Enabled If it is set to 1 (Enabled), the IP phone can automatically answer an incoming call. X ranges from 1 to 16 (for SIP-T48G/T46G/T29G) X ranges from 1 to 12 (for SIP-T42G) X ranges from 1 to 6 (for SIP-T41P/T27P) X ranges from 1 to 3 (for SIP-T23P/G) X ranges from 1 to 2 (for SIP-T21(P) E2) X is equal to 1 (for SIP-T19(P) E2) Note: The IP phone cannot automatically answer the incoming call during a call even if auto answer is enabled.</p> <p>Web User Interface: Account->Basic->Auto Answer</p> <p>Phone User Interface: For SIP-T42G/T41P/T27P/T23P/T23G/T21(P) E2/T19(P) E2: Menu->Features->Auto Answer->Status For SIP-T46G/T29G: Menu->Features->Auto Answer->Line X->Auto Answer For SIP-T48G: Menu->Features->Auto Answer->Line X->On/Off</p>		
features.auto_answer_delay	Integer from 1 to 4	1
<p>Description: Configures the delay time (in seconds) before the IP phone automatically answers an incoming call. Note: It works only if the value of the parameter "account.X.auto_answer" is set to 1 (Enabled).</p> <p>Web User Interface: Features->General Information->Auto-Answer Delay(1~4s)</p> <p>Phone User Interface:</p>		

Parameters	Permitted Values	Default
None		
features.auto_answer_tone.enable	0 or 1	1
<p>Description: Enables or disables the phone to play a warning tone when an incoming call is automatically answered.</p> <p>0-Disabled 1-Enabled</p> <p>Note: For the call coming from a SIP account, it works only if the value of the parameter "account.X.auto_answer" is set to 1 (Enabled). It is also applicable to IP calls.</p> <p>Web User Interface: Features->General Information->Enable auto answer tone</p> <p>Phone User Interface: None</p>		

To configure auto answer via web user interface:

1. Click on **Account->Basic**.
2. Select the desired account from the pull-down list of **Account**.
3. Select the desired value from the pull-down list of **Auto Answer**.

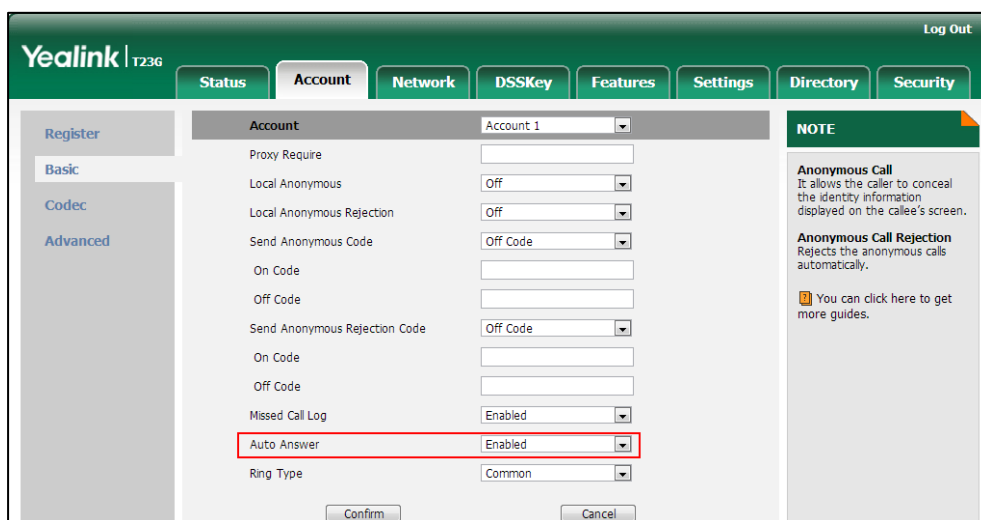

4. Click **Confirm** to accept the change.

To configure a period of delay time for auto answer via web user interface:

1. Click on **Features->General Information**.

2. Enter the desired time in the **Auto-Answer Delay(1~4s)** field.

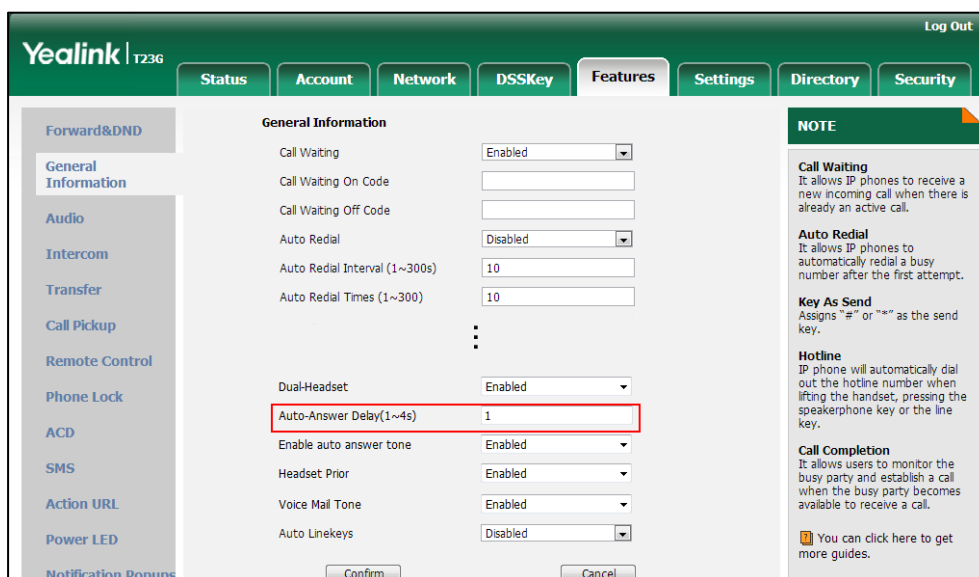

3. Click **Confirm** to accept the change.

To configure auto answer tone via web user interface:

1. Click on **Features->General Information**.
2. Select the desired value in the pull-down list of **Enable auto answer tone**.

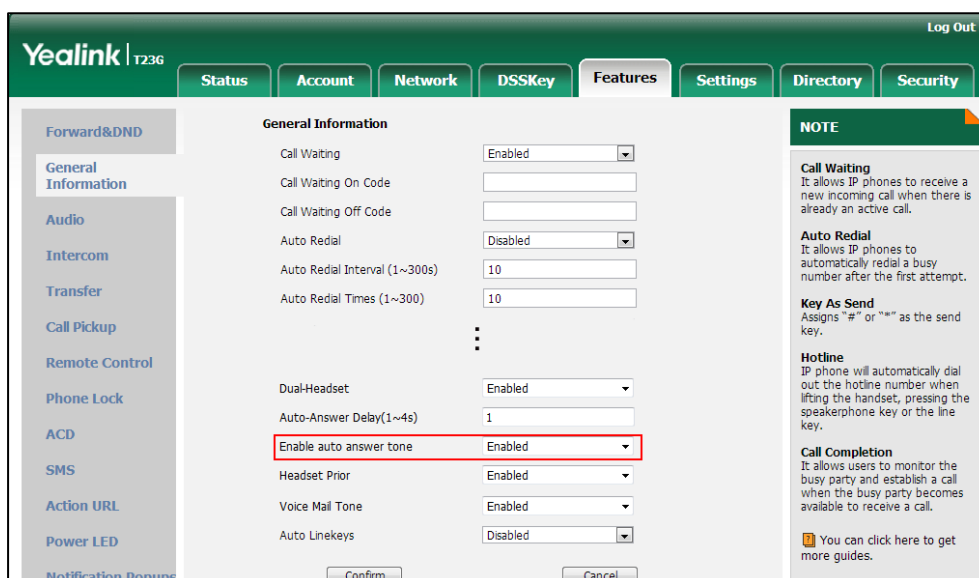

3. Click **Confirm** to accept the change.



To configure auto answer via phone user interface (take SIP-T23G IP phones for example):

1. Press **Menu->Features->Auto Answer**.
2. Press **◀** or **▶**, or the **Switch** soft key to select the desired value from the **Line ID** field.
3. Press **◀** or **▶**, or the **Switch** soft key to select the desired value from the **Status**

field.

4. Press the **Save** soft key to accept the change.

To configure auto answer via phone user interface (take SIP-T46G IP phones for example):

1. Press **Menu->Features->Auto Answer**.
2. Select the desired line.
3. Press  or  , or the **Switch** soft key to select the desired value from the **Auto Answer** field.
4. Press the **Save** soft key to accept the change.

To configure auto answer via phone user interface (take SIP-T48G IP phones for example):

1. Tap  ->**Features->Auto Answer**.
2. Tap the **On** radio box of the desired line.
3. Tap the **Save** soft key to accept the change.

IP Direct Auto Answer

IP direct auto answer allows IP phones to automatically answer an IP address call. IP direct auto answer works only if allow IP call is enabled. For more information on allow IP call, refer to [Allow IP Call](#) on page 239.

Procedure

IP direct auto answer can only be configured using the configuration files or locally.

Configuration File	<y0000000000xx>.cfg	Configure IP direct auto answer feature. Parameter: features.ip_call_auto_answer.enable
Local	Web User Interface	Configure IP direct auto answer feature. Navigate to: http://<phoneIPAddress>/servlet?p=features-general&q=load

Details of Configuration Parameters:

Parameters	Permitted Values	Default
features.ip_call_auto_answer.enable	0 or 1	0
<p>Description: Enables or disables the auto answer feature for IP call. 0-Disabled 1-Enabled If it is set to 1 (Enabled), the IP phone can automatically answer IP call. Note: It works only if the value of the parameter "features.direct_ip_call_enable" is set to 1 (Enabled). The IP phone cannot automatically answer the incoming IP call during a call even if IP call auto answer is enabled.</p> <p>Web User Interface: Feature->General Information->IP Direct Auto Answer</p> <p>Phone User Interface: None</p>		

To configure IP direct auto answer via web user interface:

1. Click on **Features->General Information**.
2. Select the desired value from the pull-down list of **IP Direct Auto Answer**.

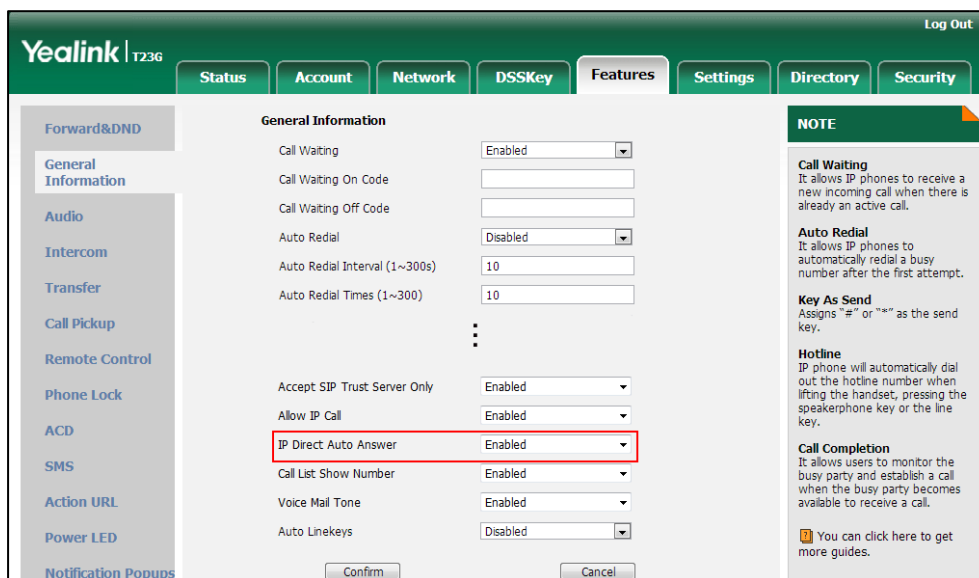

3. Click **Confirm** to accept the change.

Allow IP Call

Allow IP Call feature allow IP phones to receive or place an IP address call. You can neither receive nor place an IP address call if allow IP call feature is disabled.

Procedure

Allow IP call can be configured using the configuration files or locally.

Configuration File	<y0000000000xx>.cfg	Configure allow IP call. Parameter: features.direct_ip_call_enable
Local	Web User Interface	Configure allow IP call. Navigate to: http://<phoneIPAddress>/servlet ?p=features-general&q=load

Details of Configuration Parameters:

Parameters	Permitted Values	Default
features.direct_ip_call_enable	0 or 1	1
<p>Description: Enables or disables allow IP address call. 0-Disabled 1-Enabled</p> <p>Note: If you want to receive an IP address call, make sure the value of the parameter "sip.trust_ctrl" is set to 0 (Disabled).</p> <p>Web User Interface: Features->General Information->Allow IP Call</p> <p>Phone User Interface: None</p>		

To configure allow IP call feature via web user interface:

1. Click on **Features->General Information**.

2. Select the desired value from the pull-down list of **Allow IP Call**.

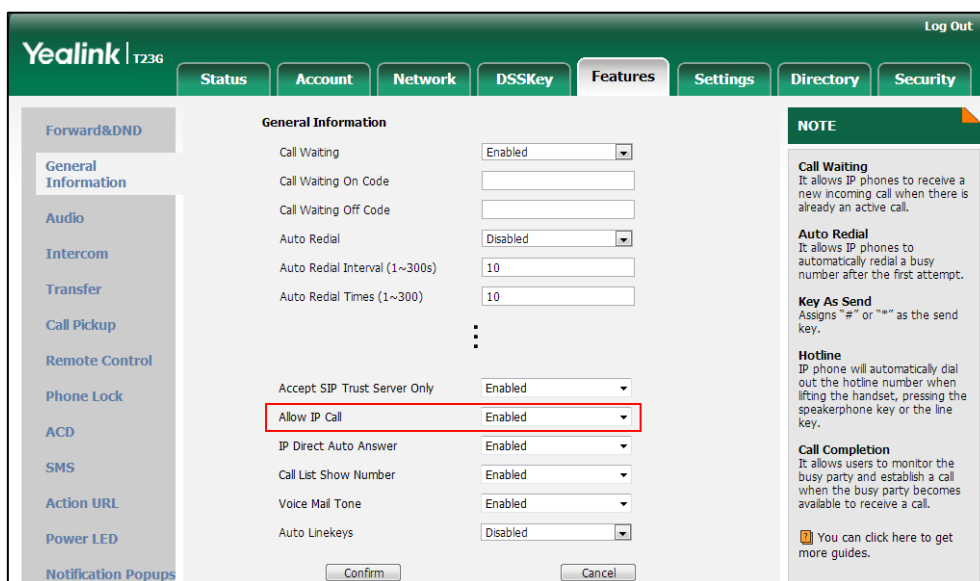

3. Click **Confirm** to accept the change.

Accept SIP Trust Server Only

Accept SIP trust server only enables the IP phones to only accept the SIP message from your SIP server and outbound proxy server. It can prevent the phone receiving ghost calls from random numbers like 100, 1000, etc. To stop this from happening, you also need to disable allow IP call feature. For more information on allow IP call, refer to [Allow IP Call](#) on page 239.

Procedure

Accept SIP trust server can be configured using the configuration files or locally.

Configuration File	<y0000000000xx>.cfg	Configure accept SIP trust server. Parameter: sip.trust_ctrl
Local	Web User Interface	Configure accept SIP trust server. Navigate to: http://<phoneIPAddress>/servlet ?p=features-general&q=load

Details of Configuration Parameters:

Parameters	Permitted Values	Default
sip.trust_ctrl	0 or 1	0

Parameters	Permitted Values	Default
<p>Description: Enables or disables the IP phone to only accept the SIP message from the SIP and outbound proxy server.</p> <p>0-Disabled 1-Enabled</p> <p>Web User Interface: Features->General Information->Accept SIP Trust Server Only</p> <p>Phone User Interface: None</p>		

To configure accept SIP trust server only feature via web user interface:

1. Click on **Features->General Information**.
2. Select the desired value from the pull-down list of **Accept SIP Trust Server Only**.

The screenshot shows the Yealink T236 web interface. The 'Features' tab is selected, and the 'General Information' sub-tab is active. The 'Accept SIP Trust Server Only' option is highlighted with a red box and is currently set to 'Enabled'. Other configuration options include Call Waiting (Enabled), Call Waiting On Code, Call Waiting Off Code, Auto Redial (Disabled), Auto Redial Interval (1~300s) (10), and Auto Redial Times (1~300) (10). A 'NOTE' section on the right provides additional information about various features like Call Waiting, Auto Redial, Key As Send, Hotline, and Call Completion.

3. Click **Confirm** to accept the change.

Call Completion

Call completion allows users to monitor the busy party and establish a call when the busy party becomes available to receive a call. Two factors commonly prevent a call from connecting successfully:

- Callee does not answer
- Callee actively rejects the incoming call before answering

IP phones support call completion using the SUBSCRIBE/NOTIFY method, which is

specified in draft-poetzl-sipping-call-completion-00, to subscribe to the busy party and receive notifications of their status changes.

Procedure

Call completion can be configured using the configuration files or locally.

Configuration File	<y0000000000xx>.cfg	Configure call completion. Parameter: features.call_completion_enable
Local	Web User Interface	Configure call completion. Navigate to: http://<phoneIPAddress>/servlet ?p=features-general&q=load
	Phone User Interface	Configure call completion.

Details of the Configuration Parameter:

Parameter	Permitted Values	Default
features.call_completion_enable	0 or 1	0
<p>Description: Enables or disables call completion feature. If a user places a call and the callee is temporarily unavailable to answer the call, call completion feature allows notifying the user when the callee becomes available to receive a call.</p> <p>0-Disabled 1-Enabled</p> <p>If it is set to 1 (Enabled), the caller is notified when the callee becomes available to receive a call.</p> <p>Web User Interface: Features->General Information->Call Completion</p> <p>Phone User Interface: Menu->Features->Call Completion->Call Completion</p>		

To configure call completion via web user interface:

1. Click on **Features->General Information**.

- Select the desired value from the pull-down list of **Call Completion**.

The screenshot shows the Yealink T236 web interface with the 'Features' tab selected. The 'General Information' section contains various settings. The 'Call Completion' field is highlighted with a red box and is set to 'Enabled'. A 'NOTE' section on the right provides details for several features:

- Call Waiting:** It allows IP phones to receive a new incoming call when there is already an active call.
- Auto Redial:** It allows IP phones to automatically redial a busy number after the first attempt.
- Key As Send:** Assigns '#' or '*' as the send key.
- Hotline:** IP phone will automatically dial out the hotline number when lifting the handset, pressing the speakerphone key or the line key.
- Call Completion:** It allows users to monitor the busy party and establish a call when the busy party becomes available to receive a call.

At the bottom of the note, there is a link: [You can click here to get more guides.](#)

- Click **Confirm** to accept the change.

To configure call completion via phone user interface:

- Press **Menu->Features->Call Completion**.
- Press **◀** or **▶** , or the **Switch** soft key to select the desired value from the **Call Completion** field.
- Press the **Save** soft key to accept the change.

Anonymous Call

Anonymous call allows the caller to conceal the identity information displayed on the callee's screen. The callee's phone LCD screen prompts an incoming call from anonymity. Anonymous call is configurable on a per-line basis.

Example of anonymous SIP header:

```
Via: SIP/2.0/UDP 10.3.20.14:5060;branch=z9hG4bK3074920774
From: "Anonymous" <sip:anonymous@anonymous.invalid>;tag=131654239
To: <sip:1006@10.3.5.199:5060>
Call-ID: 0_288363101@10.3.20.14
CSeq: 1 INVITE
Contact: <sip:1009@10.3.20.14:5060>
Content-Type: application/sdp
Allow: INVITE, INFO, PRACK, ACK, BYE, CANCEL, OPTIONS, NOTIFY, REGISTER, SUBSCRIBE, REFER, PUBLISH, UPDATE, MESSAGE
Max-Forwards: 70
User-Agent: Yealink SIP-T23G 44.80.0.20
```

Allow-Events: talk,hold,conference,refer,check-sync
 P-Preferred-Identity: <sip:1009@10.3.5.199>
 Privacy: id
 Content-Length: 302

The anonymous call on code and anonymous call off code configured on IP phones are used to activate/deactivate the server-side anonymous call feature. They may vary on different servers. Send Anonymous Code feature allows IP phones to send anonymous on/off code to the server.

Procedure

Anonymous call can be configured using the configuration files or locally.

Configuration File	<MAC>.cfg	Configure anonymous call. Parameters: account.X.anonymous_call account.X.send_anonymous_code account.X.anonymous_call_oncode account.X.anonymous_call_offcode
Local	Web User Interface	Configure anonymous call. Navigate to: <a href="http://<phoneIPAddress>/servlet?p=account-basic&q=load&acc=0">http://<phoneIPAddress>/servlet?p=account-basic&q=load&acc=0
	Phone User Interface	Configure anonymous call.

Details of Configuration Parameters:

Parameters	Permitted Values	Default
account.X.anonymous_call	0 or 1	0
<p>Description: Triggers the anonymous call feature to on or off for account X. 0-Off 1-On If it is set to 1 (On), the IP phone will block its identity from showing up to the callee when placing a call. The callee's phone LCD screen presents anonymous instead of the caller's identity. X ranges from 1 to 16 (for SIP-T48G/T46G/T29G) X ranges from 1 to 12 (for SIP-T42G) X ranges from 1 to 6 (for SIP-T41P/T27P)</p>		

Parameters	Permitted Values	Default
<p>X ranges from 1 to 3 (for SIP-T23P/G) X ranges from 1 to 2 (for SIP-T21(P) E2) X is equal to 1 (for SIP-T19(P) E2)</p> <p>Web User Interface: Account->Basic->Local Anonymous</p> <p>Phone User Interface: Menu->Features->Anonymous Call->Local Anonymous</p>		
account.X.send_anonymous_code	0 or 1	0
<p>Description:</p> <p>Configures the IP phone to send anonymous on/off code to activate/deactivate the server-side anonymous call feature for account X.</p> <p>0-Off Code</p> <p>1-On Code</p> <p>If it is set to 0 (Off Code), the IP phone will send anonymous off code to the server when you deactivate the anonymous call feature.</p> <p>If it is set to 1 (On Code), the IP phone will send anonymous on code to the server when you activate the anonymous call feature.</p> <p>X ranges from 1 to 16 (for SIP-T48G/T46G/T29G) X ranges from 1 to 12 (for SIP-T42G) X ranges from 1 to 6 (for SIP-T41P/T27P) X ranges from 1 to 3 (for SIP-T23P/G) X ranges from 1 to 2 (for SIP-T21(P) E2) X is equal to 1 (for SIP-T19(P) E2)</p> <p>Web User Interface: Account->Basic->Send Anonymous Code</p> <p>Phone User Interface: Menu->Features->Anonymous Call->Send Anony Code</p>		
account.X.anonymous_call_oncode	String within 32 characters	Blank

Parameters	Permitted Values	Default
<p>Description: Configures the anonymous call on code to activate the server-side anonymous call feature for account X. X ranges from 1 to 16 (for SIP-T48G/T46G/T29G) X ranges from 1 to 12 (for SIP-T42G) X ranges from 1 to 6 (for SIP-T41P/T27P) X ranges from 1 to 3 (for SIP-T23P/G) X ranges from 1 to 2 (for SIP-T21(P) E2) X is equal to 1 (for SIP-T19(P) E2)</p> <p>Example: account.1.anonymous_call_oncode = *72</p> <p>Note: It works only if the value of the parameter "account.X.send_anonymous_code" is set to 1 (On Code).</p> <p>Web User Interface: Account->Basic->Send Anonymous Code->On Code</p> <p>Phone User Interface: Menu->Features->Anonymous Call->On Code</p>		
account.X.anonymous_call_offcode	String within 32 characters	Blank
<p>Description: Configures the anonymous call off code to deactivate the server-side anonymous call feature for account X. X ranges from 1 to 16 (for SIP-T48G/T46G/T29G) X ranges from 1 to 12 (for SIP-T42G) X ranges from 1 to 6 (for SIP-T41P/T27P) X ranges from 1 to 3 (for SIP-T23P/G) X ranges from 1 to 2 (for SIP-T21(P) E2) X is equal to 1 (for SIP-T19(P) E2)</p> <p>Example: account.1.anonymous_call_offcode = *73</p> <p>Note: It works only if the value of the parameter "account.X.send_anonymous_code" is set to 0 (Off Code).</p> <p>Web User Interface: Account->Basic->Send Anonymous Code->Off Code</p> <p>Phone User Interface:</p>		

Parameters	Permitted Values	Default
Menu->Features->Anonymous Call->Off Code		

To configure anonymous call via web user interface:

1. Click on **Account->Basic**.
2. Select the desired account from the pull-down list of **Account**.
3. Select the desired value from the pull-down list of **Local Anonymous**.
4. Select the desired value from the pull-down list of **Send Anonymous Code**.
5. (Optional.) Enter the anonymous call on code in the **On Code** field.
6. (Optional.) Enter the anonymous call off code in the **Off Code** field.

The screenshot shows the Yealink web interface for Account 1. The 'Local Anonymous' dropdown is set to 'On', and the 'Send Anonymous Code' dropdown is set to 'On Code'. The 'On Code' field contains '*72' and the 'Off Code' field contains '*73'. A 'NOTE' box on the right explains 'Anonymous Call' and 'Anonymous Call Rejection'.

7. Click **Confirm** to accept the change.

To configure the anonymous call via phone user interface:

1. Press **Menu->Features->Anonymous Call**.
2. Press **◀** or **▶**, or the **Switch** soft key to select the desired line from the **Line ID** field.
3. Press **◀** or **▶**, or the **Switch** soft key to select the desired value from the **Local Anonymous** field.
4. (Optional.) Press **◀** or **▶**, or the **Switch** soft key to select the desired value from the **Send Anony Code** field.
5. (Optional.) Enter the anonymous call on code in the **On Code** field.
6. (Optional.) Enter the anonymous call off code in the **Off Code** field.

Anonymous Call Rejection

Anonymous call rejection allows IP phones to automatically reject incoming calls from

callers whose identity has been deliberately concealed. The anonymous caller's phone LCD screen presents "Anonymity Disallowed". Anonymous call rejection is configurable on a per-line basis.

The anonymous call rejection on code and anonymous call rejection off code configured on IP phones are used to activate/deactivate the server-side anonymous call rejection feature. They may vary on different servers. Send Anonymous Rejection Code feature allows IP phones to send anonymous call rejection on/off code to the server.

Procedure

Anonymous call rejection can be configured using the configuration files or locally.

Configuration File	<MAC>.cfg	Configure anonymous call rejection. Parameters: account.X.reject_anonymous_call account.X.send_anonymous_rejection_code account.X.anonymous_reject_oncode account.X.anonymous_reject_offcode
Local	Web User Interface	Configure anonymous call rejection. Navigate to: http://<phoneIPAddress>/servlet?p=account-basic&q=load&acc=0
	Phone User Interface	Configure anonymous call rejection.

Details of Configuration Parameters:

Parameters	Permitted Values	Default
account.X.reject_anonymous_call	0 or 1	0
<p>Description: Triggers the anonymous call rejection feature to on or off for account X.</p> <p>0-Off 1-On</p> <p>If it is set to 1 (On), the IP phone will automatically reject incoming calls from users enabled anonymous call feature. The anonymous user's phone LCD screen presents "Anonymity Disallowed".</p> <p>X ranges from 1 to 16 (for SIP-T48G/T46G/T29G) X ranges from 1 to 12 (for SIP-T42G) X ranges from 1 to 6 (for SIP-T41P/T27P)</p>		

Parameters	Permitted Values	Default
<p>X ranges from 1 to 3 (for SIP-T23P/G) X ranges from 1 to 2 (for SIP-T21(P) E2) X is equal to 1 (for SIP-T19(P) E2)</p> <p>Web User Interface: Account->Basic->Local Anonymous Rejection</p> <p>Phone User Interface: Menu->Features->Anonymous Call->Anonymous Rejection</p>		
account.X.send_anonymous_rejection_code	0 or 1	0
<p>Configures the IP phone to send anonymous rejection on/off code to activate/deactivate the server-side anonymous call rejection feature for account X.</p> <p>0- Off code 1- On code</p> <p>If it is set to 0 (Off Code), the IP phone will send anonymous rejection off code to the server when you deactivate the anonymous call rejection feature.</p> <p>If it is set to 1 (On Code), the IP phone will send anonymous rejection on code to the server when you activate the anonymous call rejection feature.</p> <p>X ranges from 1 to 16 (for SIP-T48G/T46G/T29G) X ranges from 1 to 12 (for SIP-T42G) X ranges from 1 to 6 (for SIP-T41P/T27P) X ranges from 1 to 3 (for SIP-T23P/G) X ranges from 1 to 2 (for SIP-T21(P) E2) X is equal to 1 (for SIP-T19(P) E2)</p> <p>Web User Interface: Account->Basic->Send Anonymous Rejection Code</p> <p>Phone User Interface: Menu->Features->Anonymous Call->Send Rejection Code</p>		
account.X.anonymous_reject_oncode	String within 32 characters	Blank
<p>Description:</p> <p>Configures the anonymous call rejection on code to activate the server-side anonymous call rejection feature for account X.</p> <p>X ranges from 1 to 16 (for SIP-T48G/T46G/T29G) X ranges from 1 to 12 (for SIP-T42G) X ranges from 1 to 6 (for SIP-T41P/T27P)</p>		

Parameters	Permitted Values	Default
<p>X ranges from 1 to 3 (for SIP-T23P/G) X ranges from 1 to 2 (for SIP-T21(P) E2) X is equal to 1 (for SIP-T19(P) E2)</p> <p>Example: account.1.anonymous_reject_oncode = *74</p> <p>Note: It works only if the value of the parameter "account.X.send_anonymous_rejection_code" is set to 1 (On Code).</p> <p>Web User Interface: Account->Basic->Send Anonymous Rejection Code->On Code</p> <p>Phone User Interface: Menu->Features->Anonymous Call->Reject On Code</p>		
account.X.anonymous_reject_offcode	String within 32 characters	Blank
<p>Description: Configures the anonymous call rejection off code to deactivate the server-side anonymous call rejection feature for account X.</p> <p>X ranges from 1 to 16 (for SIP-T48G/T46G/T29G) X ranges from 1 to 12 (for SIP-T42G) X ranges from 1 to 6 (for SIP-T41P/T27P) X ranges from 1 to 3 (for SIP-T23P/G) X ranges from 1 to 2 (for SIP-T21(P) E2) X is equal to 1 (for SIP-T19(P) E2)</p> <p>Example: account.1.anonymous_reject_offcode = *75</p> <p>Note: It works only if the value of the parameter "account.X.send_anonymous_rejection_code" is set to 0 (Off Code).</p> <p>Web User Interface: Account->Basic->Send Anonymous Rejection Code->Off Code</p> <p>Phone User Interface: Menu->Features->Anonymous Call->Reject Off Code</p>		

To configure anonymous call rejection via web user interface:

1. Click on **Account->Basic**.
2. Select the desired account from the pull-down list of **Account**.
3. Select the desired value from the pull-down list of **Local Anonymous Rejection**.
4. Select the desired value from the pull-down list of **Send Anonymous Rejection**

code.

5. (Optional.) Enter the Send Anonymous Rejection on code in the **On Code** field.
6. (Optional.) Enter the Send Anonymous Rejection off code in the **Off Code** field.

The screenshot shows the Yealink T236 web interface with the 'Account' tab selected. The 'Account' configuration page is displayed for 'Account 1'. The 'Local Anonymous Rejection' dropdown is set to 'On', and the 'Send Anonymous Rejection Code' dropdown is set to 'Off Code'. The 'On Code' field contains '*74' and the 'Off Code' field contains '*75'. A 'NOTE' box on the right explains 'Anonymous Call' and 'Anonymous Call Rejection'.

7. Click **Confirm** to accept the change.

To configure anonymous call rejection via phone user interface:

1. Press **Menu->Features->Anonymous Call**.
2. Press **◀** or **▶**, or the **Switch** soft key to select the desired line from the **Line ID** field.
3. Press **▲** or **▼** to scroll to the **Anonymous Rejection** field.
4. Press **◀** or **▶** to select **Enabled** from the **Anonymous Rejection** field.
5. Press **▲** or **▼** to scroll to the **Send Rejection Code** field.
6. (Optional.) Press **◀** or **▶** to select the desired value from the **Send Rejection Code** field.
7. (Optional.) Enter the anonymous call rejection on code and off code respectively in the **Reject On Code** and **Reject Off Code** field.
8. Press the **Save** soft key to accept the change or the **Back** soft key to cancel.

Do Not Disturb (DND)

DND allows IP phones to ignore incoming calls. DND feature can be configured on a phone or a per-line basis depending on the DND mode. Two DND modes:

- **Phone** (default): DND feature is effective for the IP phone.
- **Custom**: DND feature can be configured for each or all accounts.

A user can activate or deactivate DND using the DND key or DND soft key. The server-side DND feature disables the local DND and call forward settings. If the server-side DND feature is enabled on any of the IP phone's registrations, the other

registrations are not affected. For more information on call forward, refer to [Call Forward](#) on page 284.

The DND on code and DND off code configured on IP phones are used to activate/deactivate the server-side DND feature. They may vary on different servers.

Return Message When DND

This feature defines the return code and the reason of the SIP response message for the rejected incoming call when DND is enabled on the IP phone. The caller's phone LCD screen displays the received return code.

DND Emergency

This feature allows users to receive the incoming calls from some authorized numbers even if the DND feature is enabled. This feature is disabled by default.

Procedure

DND can be configured using the configuration files or locally.

Configuration File	<MAC>.cfg	<p>Configure DND in the custom mode.</p> <p>Parameters: account.X.dnd.enable account.X.dnd.on_code account.X.dnd.off_code</p>
	<y0000000000xx>.cfg	<p>Configure the DND mode.</p> <p>Parameter: features.dnd_mode</p> <p>Configure DND in the phone mode.</p> <p>Parameters: features.dnd.enable features.dnd.on_code features.dnd.off_code</p> <p>Specify the authorized numbers when DND is enabled.</p> <p>Parameters: features.dnd.emergency_enable features.dnd.emergency_authorized_number</p> <p>Specify the return code and the reason of the SIP response</p>

		<p>message when DND is enabled.</p> <p>Parameter:</p> <p>features.dnd_refuse_code</p> <p>Assign a DND key.</p> <p>Parameters:</p> <p>linekey.X.type/ programablekey.X.type/ expansion_module.X.key.Y.type</p> <p>linekey.X.label/ programablekey.X.label/ expansion_module.X.key.Y.label</p>
Local	Web User Interface	<p>Configure DND.</p> <p>Navigate to:</p> <p>http://<phoneIPAddress>/servlet? p=features-forward&q=load</p> <p>Specify the authorized numbers when DND is enabled.</p> <p>Specify the return code and the reason of the SIP response message when DND is enabled.</p> <p>Navigate to:</p> <p>http://<phoneIPAddress>/servlet? p=features-general&q=load</p> <p>Assign a DND key.</p> <p>Navigate to:</p> <p>http://<phoneIPAddress>/servlet? p=dsskey&q=load&model=0</p>
	Phone User Interface	<p>Configure DND.</p> <p>Assign a DND key.</p>

Details of Configuration Parameters:

Parameters	Permitted Values	Default
features.dnd_mode	0 or 1	0
<p>Description:</p> <p>Configures the DND mode for the IP phone.</p> <p>0-Phone</p>		

<p>1-Custom</p> <p>If it is set to 0 (Phone), DND feature is effective for the IP phone.</p> <p>If it is set to 1 (Custom), you can configure DND feature for each account.</p> <p>Note: It is not applicable to SIP-T19(P) E2 IP phones.</p> <p>Web User Interface:</p> <p>Features->Forward&DND->DND->Mode</p> <p>Phone User Interface:</p> <p>None</p>		
account.X.dnd.enable	0 or 1	0
<p>Description:</p> <p>Triggers DND feature to on or off for account X.</p> <p>0-Off</p> <p>1-On</p> <p>If it is set to 1 (On), the IP phone will reject incoming calls on account X.</p> <p>X ranges from 1 to 16 (for SIP-T48G/T46G/T29G)</p> <p>X ranges from 1 to 12 (for SIP-T42G)</p> <p>X ranges from 1 to 6 (for SIP-T41P/T27P)</p> <p>X ranges from 1 to 3 (for SIP-T23P/G)</p> <p>X ranges from 1 to 2 (for SIP-T21(P) E2)</p> <p>Note: It works only if the value of the parameter "features.dnd_mode" is set to 1 (Custom). It is not applicable to SIP-T19(P) E2 IP phones.</p> <p>Web User Interface:</p> <p>Features->Forward&DND->DND->DND Status</p> <p>Phone User Interface:</p> <p>Menu->Features->DND->AccountX->DND Enable.</p>		
account.X.dnd.on_code	String within 32 characters	Blank
<p>Description:</p> <p>Configures the DND on code to activate the server-side DND feature for account X. The IP phone will send the DND on code to the server when you activate DND feature for account X on the IP phone.</p> <p>X ranges from 1 to 16 (for SIP-T48G/T46G/T29G)</p> <p>X ranges from 1 to 12 (for SIP-T42G)</p> <p>X ranges from 1 to 6 (for SIP-T41P/T27P)</p> <p>X ranges from 1 to 3 (for SIP-T23P/G)</p> <p>X ranges from 1 to 2 (for SIP-T21(P) E2)</p>		

<p>Example:</p> <p>account.1.dnd.on_code = *73</p> <p>Note: It works only if the value of the parameter “features.dnd_mode” is set to 1 (Custom). It is not applicable to SIP-T19(P) E2 IP phones.</p> <p>Web User Interface:</p> <p>Features->Forward&DND->DND On Code</p> <p>Phone User Interface:</p> <p>Menu->Features->DND->AccountX->On Code</p>		
account.X.dnd.off_code	String within 32 characters	Blank
<p>Description:</p> <p>Configures the DND off code to deactivate the server-side DND feature for account X. The IP phone will send the DND off code to the server when you deactivate DND feature for account X on the IP phone.</p> <p>X ranges from 1 to 16 (for SIP-T48G/T46G/T29G)</p> <p>X ranges from 1 to 12 (for SIP-T42G)</p> <p>X ranges from 1 to 6 (for SIP-T41P/T27P)</p> <p>X ranges from 1 to 3 (for SIP-T23P/G)</p> <p>X ranges from 1 to 2 (for SIP-T21(P) E2)</p> <p>Example:</p> <p>account.1.dnd.off_code = *74</p> <p>Note: It works only if the value of the parameter “features.dnd_mode” is set to 1 (Custom). It is not applicable to SIP-T19(P) E2 IP phones.</p> <p>Web User Interface:</p> <p>Features->Forward&DND->DND Off Code</p> <p>Phone User Interface:</p> <p>Menu->Features->DND->AccountX->Off Code</p>		
features.dnd.enable	0 or 1	0
<p>Description:</p> <p>Triggers DND feature to on or off.</p> <p>0-Off</p> <p>1-On</p> <p>If it is set to 1 (On), the IP phone will reject incoming calls on all accounts.</p> <p>Note: For Yealink IP phones (except SIP-T19(P) E2), it works only if the value of the parameter “features.dnd_model” is set to 0 (Phone).</p> <p>Web User Interface:</p>		

Features->Forward&DND->DND->DND Status Phone User Interface: Menu->Features->DND->DND Enable		
features.dnd.on_code	String within 32 characters	Blank
Description: Configures the DND on code to activate the server-side DND feature. The IP phone will send the DND on code to the server when you activate DND feature on the IP phone. Example: features.dnd.on_code = *71 Note: For Yealink IP phones (except SIP-T19(P) E2), it works only if the value of the parameter "features.dnd_mode" is set to 0 (Phone). Web User Interface: Features->Forward&DND->DND->DND On Code Phone User Interface: Menu->Features->DND->On Code		
features.dnd.off_code	String within 32 characters	Blank
Description: Configures the DND off code to deactivate the server-side DND feature. The IP phone will send the DND off code to the server when you deactivate DND feature on the IP phone. Example: features.dnd.off_code = *72 Note: For Yealink IP phones (except SIP-T19(P) E2), it works only if the value of the parameter "features.dnd_mode" is set to 0 (Phone). Web User Interface: Features->Forward&DND->DND->DND Off Code Phone User Interface: Menu->Features->DND->Off Code		
features.dnd.emergency_enable	0 or 1	0
Description: Enables or disables the IP phone to receive incoming calls from authorized numbers when DND feature is enabled. 0-Disabled		

<p>1-Enabled</p> <p>Web User Interface: Features->Forward&DND->DND->DND Emergency</p> <p>Phone User Interface: None</p>		
features.dnd.emergency_authorized_number	String within 511 characters	Blank
<p>Description: Configures the authorized numbers the IP phone can receive incoming calls from even if DND feature is enabled. Multiple numbers are separated by commas.</p> <p>Example: features.dnd.emergency_authorized_number = 123,124</p> <p>Note: It works only if the value of the parameter "features.dnd.emergency_enable" is set to 1 (Enabled).</p> <p>Web User Interface: Features->Forward&DND->DND->DND Authorized Numbers</p> <p>Phone User Interface: None</p>		
features.dnd_refuse_code	404, 480, 486 or 603	480
<p>Description: Configures a return code and reason of SIP response messages when rejecting an incoming call by DND. A specific reason is displayed on the caller's phone LCD screen.</p> <p>404-Not Found 480-Temporarily Unavailable 486-Busy Here 603-Decline</p> <p>If it is set to 486 (Busy Here), the caller's phone LCD screen will display the reason "Busy Here" when the callee enables DND.</p> <p>Web User Interface: Features->General Information->Return Code When DND</p> <p>Phone User Interface: None</p>		

DND Key

For more information on how to configure the DSS Key, refer to [Appendix D: Configuring DSS Key](#) on page 751.

Parameter	Permitted Values	Default
linekey.X.type/ programablekey.X.type/ expansion_module.X.key.Y.type	5	Refer to the following content
<p>Description: Configures a DSS key as a DND key on the IP phone. The digit 5 stands for the key type DND. For line keys: X ranges from 1 to 29 (for SIP-T48G) X ranges from 1 to 27 (for SIP-T46G/T29G) X ranges from 1 to 15 (for SIP-T42G/T41P) X ranges from 1 to 21 (for SIP-T27P) X ranges from 1 to 3 (for SIP-T23P/G) X ranges from 1 to 2 (for SIP-T21(P) E2) For programable keys: X=1-10, 12-14 (for SIP-T48G/T46G) X=1-10, 13 (for SIP-T42G/T41P) X=1-14 (for SIP-T29G/T27P) X=1-10, 14 (for SIP-T23P/T23G/T21(P) E2) X=1-9, 13, 14 (for SIP-T19(P) E2) For ext keys: X ranges from 1 to 6, Y ranges from 1 to 20, 22 to 40 (Ext key 21 cannot be configured). Example: linekey.1.type = 5 Default: For line keys: For SIP-T48G IP phones: The default value of the line key 1-16 is 15, and the default value of the line key 17-29 is 0. For SIP-T46G/T29G IP phones: The default value of the line key 1-16 is 15, and the default value of the line key 17-27</p>		

Parameter	Permitted Values	Default
<p>is 0.</p> <p>For SIPT42G IP phones:</p> <p>The default value of the line key 1-12 is 15, and the default value of the line key 13-15 is 0.</p> <p>For SIPT41P IP phones:</p> <p>The default value of the line key 1-6 is 15, and the default value of the line key 7-15 is 0.</p> <p>For SIPT27P IP phones:</p> <p>The default value of the line key 1-6 is 15, and the default value of the line key 7-21 is 0.</p> <p>For SIPT23P/T23G/T21 (P) E2 IP phones:</p> <p>The default value is 15.</p> <p>For programable keys:</p> <p>For SIPT48G/T46G IP phones:</p> <p>When X=1, the default value is 28 (History).</p> <p>When X=2, the default value is 61 (Directory).</p> <p>When X=3, the default value is 5 (DND).</p> <p>When X=4, the default value is 30 (Menu).</p> <p>When X=5, the default value is 28 (History).</p> <p>When X=6, the default value is 61 (Directory).</p> <p>When X=7, the default value is 0 (NA).</p> <p>When X=8, the default value is 0 (NA).</p> <p>When X=9, the default value is 33 (Status).</p> <p>When X=10, the default value is 0 (NA).</p> <p>When X=12, the default value is 0 (NA).</p> <p>When X=13, the default value is 0 (NA).</p> <p>When X=14, the default value is 2 (Forward).</p> <p>For SIPT42G/T41P IP phones:</p> <p>When X=1, the default value is 28 (History).</p> <p>When X=2, the default value is 61 (Directory).</p> <p>When X=3, the default value is 5 (DND).</p> <p>When X=4, the default value is 30 (Menu).</p> <p>When X=5, the default value is 28 (History).</p> <p>When X=6, the default value is 61 (Directory).</p> <p>When X=7, the default value is 0 (NA).</p>		

Parameter	Permitted Values	Default
<p>When X=8, the default value is 0 (NA).</p> <p>When X=9, the default value is 33 (Status).</p> <p>When X=10, the default value is 0 (NA).</p> <p>When X=13, the default value is 0 (NA).</p> <p>For SIP-T29G/T27P IP phones:</p> <p>When X=1, the default value is 28 (History).</p> <p>When X=2, the default value is 61 (Directory).</p> <p>When X=3, the default value is 5 (DND).</p> <p>When X=4, the default value is 30 (Menu).</p> <p>When X=5, the default value is 28 (History).</p> <p>When X=6, the default value is 61 (Directory).</p> <p>When X=7, the default value is 0 (NA).</p> <p>When X=8, the default value is 0 (NA).</p> <p>When X=9, the default value is 33 (Status).</p> <p>When X=10, the default value is 0 (NA).</p> <p>When X=11, the default value is 0 (NA).</p> <p>When X=12, the default value is 0 (NA).</p> <p>When X=13, the default value is 0 (NA).</p> <p>When X=14, the default value is 2 (Forward).</p> <p>For SIP-T23P/T23G/T21(P) E2 IP phones:</p> <p>When X=1, the default value is 28 (History).</p> <p>When X=2, the default value is 61 (Directory).</p> <p>When X=3, the default value is 5 (DND).</p> <p>When X=4, the default value is 30 (Menu).</p> <p>When X=5, the default value is 28 (History).</p> <p>When X=6, the default value is 61 (Directory).</p> <p>When X=7, the default value is 0 (NA).</p> <p>When X=8, the default value is 0 (NA).</p> <p>When X=9, the default value is 33 (Status).</p> <p>When X=10, the default value is 0 (NA).</p> <p>When X=14, the default value is 2 (Forward).</p> <p>For SIP-T19(P) E2 IP phones:</p> <p>When X=1, the default value is 28 (History).</p> <p>When X=2, the default value is 61 (Directory).</p> <p>When X=3, the default value is 5 (DND).</p>		

Parameter	Permitted Values	Default
<p>When X=4, the default value is 30 (Menu). When X=5, the default value is 28 (History). When X=6, the default value is 61 (Directory). When X=7, the default value is 0 (NA). When X=8, the default value is 0 (NA). When X=9, the default value is 33 (Status). When X=13, the default value is 0 (NA). When X=14, the default value is 2 (Forward).</p> <p>For ext keys: When Y=1, the default value is 37 (Switch). When Y= 2 to 20, 22 to 40, the default value is 0 (NA).</p> <p>Web User Interface: DSSKey->Line Key/Programable Key->Type</p> <p>Phone User Interface: Menu->Features->DSS Keys->Line Key X->Type</p>		
linekey.X.label/ programablekey.X.label/ expansion_module.X.key.Y.label	String within 99 characters	Blank
<p>Description: (Optional.) Configures the label displayed on the LCD screen for each DSS key.</p> <p>For line keys: X ranges from 1 to 29 (for SIP-T48G) X ranges from 1 to 27 (for SIP-T46G/T29G) X ranges from 1 to 15 (for SIP-T42G/T41P) X ranges from 1 to 21 (for SIP-T27P) X ranges from 1 to 3 (for SIP-T23P/G) X ranges from 1 to 2 (for SIP-T21(P) E2)</p> <p>For programable keys: X ranges from 1 to 4.</p> <p>For ext keys: X ranges from 1 to 6, Y ranges from 1 to 20, 22 to 40 (Ext key 21 cannot be configured).</p> <p>Web User Interface: DSSKey->Line Key/Programable Key->Label</p> <p>Phone User Interface:</p>		

Parameter	Permitted Values	Default
Menu->Features->DSS Keys->Line Key X->Label		

To configure a DND key via web user interface:

1. Click on **DSSKey->Line Key** (or **Programmable Key**).
2. In the desired DSS key field, select **DND** from the pull-down list of **Type**.
3. (Optional.) Enter the string that will appear on the LCD screen in the **Label** field.

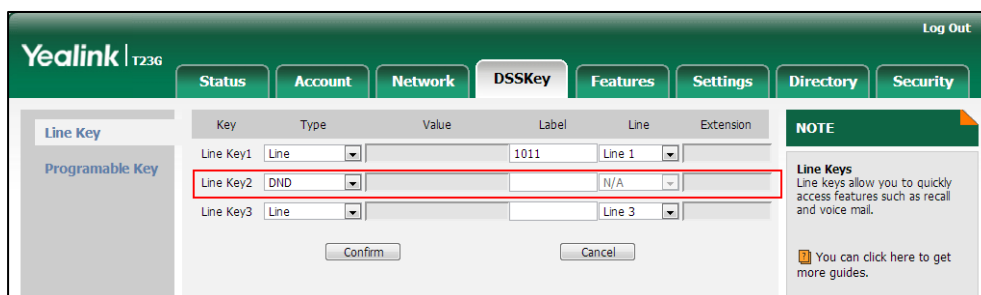

4. Click **Confirm** to accept the change.

To configure DND feature via web user interface:

1. Click on **Features->Forward&DND**.
2. In the **DND** block, mark the desired radio box in the **Mode** field.
 - a) If you mark the **Phone** radio box:
 - 1) Mark the desired radio box in the **DND Status** field.
 - 2) (Optional.) Enter the DND on code in the **DND On Code** field.

- 3) (Optional.) Enter the DND off code in the **DND Off Code** field.

The screenshot shows the Yealink T236 web interface with the 'Features' tab selected. The 'Forward' configuration page is displayed, showing various call forwarding options. The 'DND' section is highlighted with a red box. The 'DND Off Code' field is empty.

Forward

Forward Emergency: Enabled

Forward Authorized Numbers: 1014

Mode

Account: 1011

Always Forward

Target: []

On Code: []

Off Code: []

Busy Forward

Target: []

On Code: []

Off Code: []

No Answer Forward

After Ring Time(0~120s): 108

Target: []

On Code: []

Off Code: []

DND

DND Emergency: Enabled

DND Authorized Numbers: 123,124

Mode

Account: 1011

DND Status: On Off

DND On Code: []

DND Off Code: []

NOTE

Call Forward
It allows users to redirect an incoming call to a third party.

Call Forward Mode
Phone: Call forward feature is effective for the IP phone.
Custom: Call forward feature can be configured for each or all accounts.

Do Not Disturb (DND)
It allows IP phones to ignore incoming calls.

DND Mode
Phone: DND feature is effective for the IP phone.
Custom: DND feature can be configured for each or all accounts.

You can click here to get more guides.

- b) If you mark the **Custom** radio box:
- 1) Select the desired account from the pull-down list of **Account**.
 - 2) Mark the desired radio box in the **DND Status** field.
 - 3) (Optional.) Enter the DND on code in the **DND On Code** field.

- 4) (Optional.) Enter the DND off code in the **DND Off Code** field.

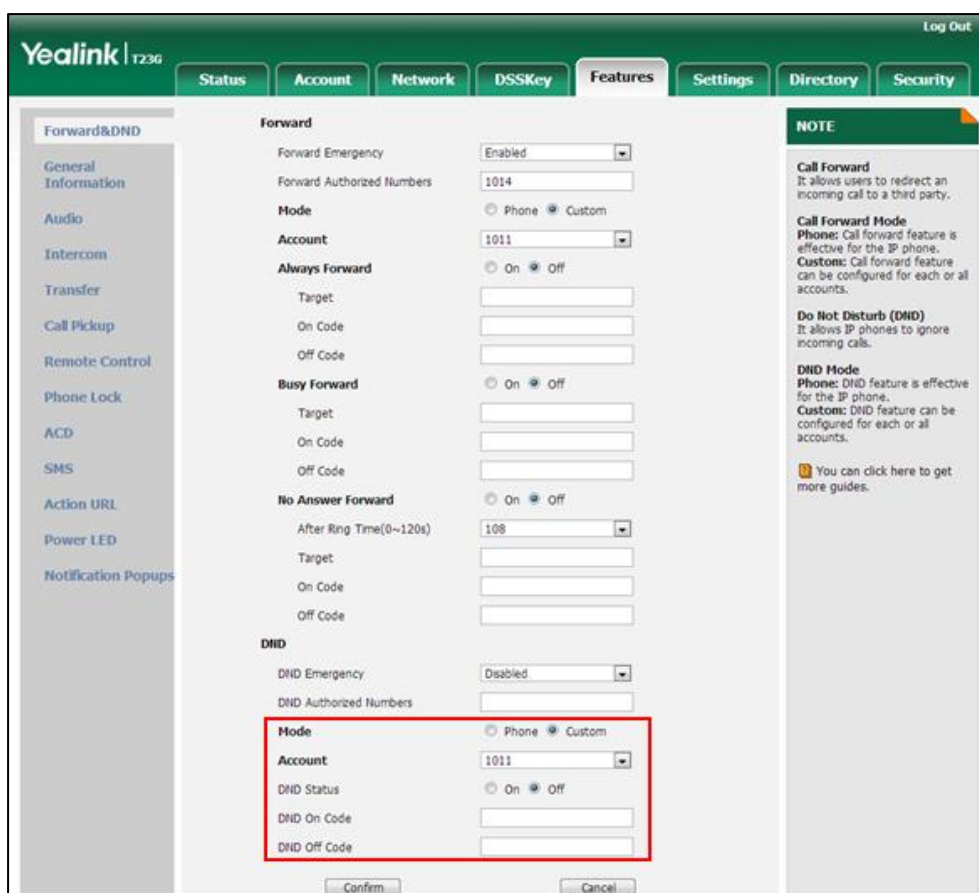

3. Click **Confirm** to accept the change.

To specify the authorized numbers when DND is enabled via web user interface:

1. Click on **Features->General Information**.
2. Select the desired value from the pull-down list of **DND Emergency**.
3. Enter the desired value in the **DND Authorized Numbers** field.

Multiple numbers are separated by commas.

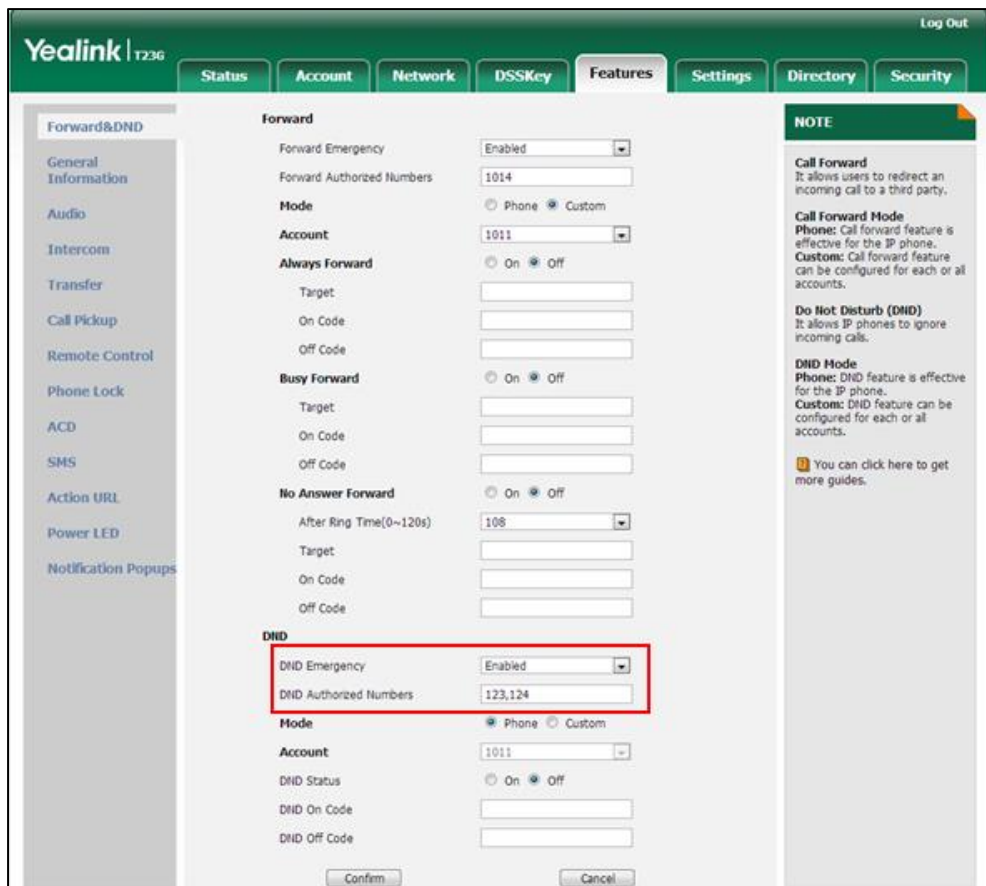

4. Click **Confirm** to accept the change.



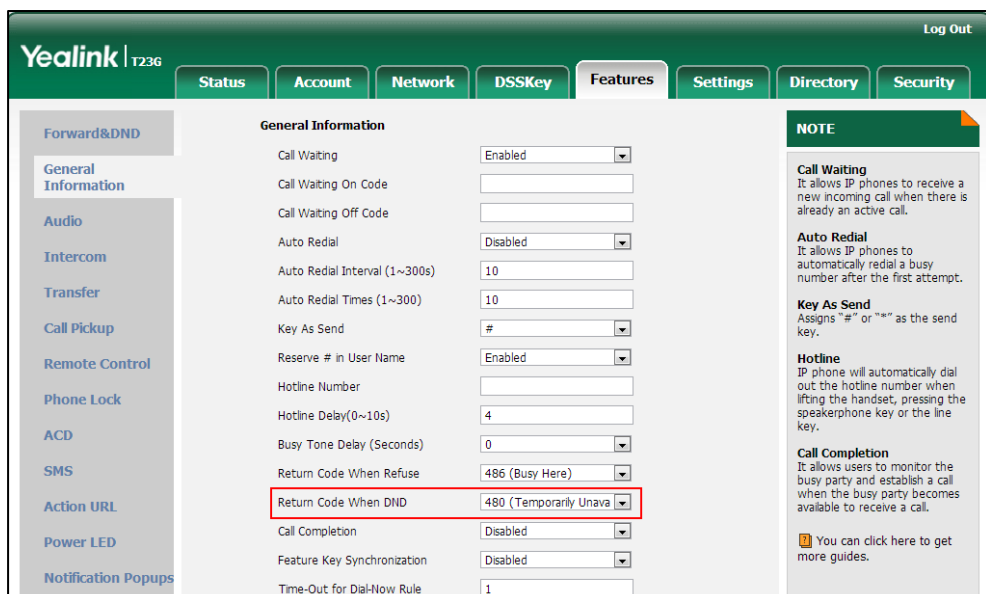

To specify the return code and the reason when DND is enabled via web user interface:

1. Click on **Features->General Information**.
2. Select the desired value from the pull-down list of **Return Code When DND**.



3. Click **Confirm** to accept the change.

To configure a DND key via phone user interface:

1. Press **Menu->Features->DSS Keys**.
2. Select the desired DSS key.
3. Press  or , or the **Switch** soft key to select **Key Event** from the **Type** field.
4. Press  or , or the **Switch** soft key to select **DND** from the **Key Type** field.
5. (Optional.) Enter the string that will appear on the LCD screen in the **Label** field.
6. Press the **Save** soft key to accept the change.





To configure DND in the phone mode via phone user interface:

1. Press the **DND** soft key or the DND key when the IP phone is idle.

To configure DND in the custom mode for a specific account via phone user interface:

1. Press the **DND** soft key or the DND key when the IP phone is idle.

The LCD screen displays a list of accounts registered on the IP phone.

2. Press  or  to select the desired account.
3. Press  or  to select **Enabled** to activate DND.

You can configure DND in the custom mode for all accounts by pressing the **All On** soft key.

4. Press the **Save** soft key to accept the change.

Busy Tone Delay

Busy tone is audible to the other party, indicating that the call connection has been broken when one party releases a call. Busy tone delay can define a period of time during which the busy tone is audible.

Procedure

Busy tone delay can be configured using the configuration files or locally.

Configuration File	<y0000000000xx>.cfg	Configure busy tone delay. Parameter: features.busy_tone_delay
Local	Web User Interface	Configure busy tone delay. Navigate to: http://<phoneIPAddress>/servlet ?p=features-general&q=load

Details of the Configuration Parameter:

Parameter	Permitted Values	Default
features.busy_tone_delay	0, 3 or 5	0

Description:
 Configures the duration time (in seconds) for the busy tone.
 When one party releases the call, a busy tone is audible to the other party indicating that the call connection breaks.

0-0s
3-3s
5-5s

If it is set to 3 (3s), a busy tone is audible for 3 seconds on the IP phone.

Web User Interface:
 Features->General Information->Busy Tone Delay (Seconds)

Phone User Interface:
 None

To configure busy tone delay via web user interface:

1. Click on **Features->General Information**.
2. Select the desired value from the pull-down list of **Busy Tone Delay (Seconds)**.

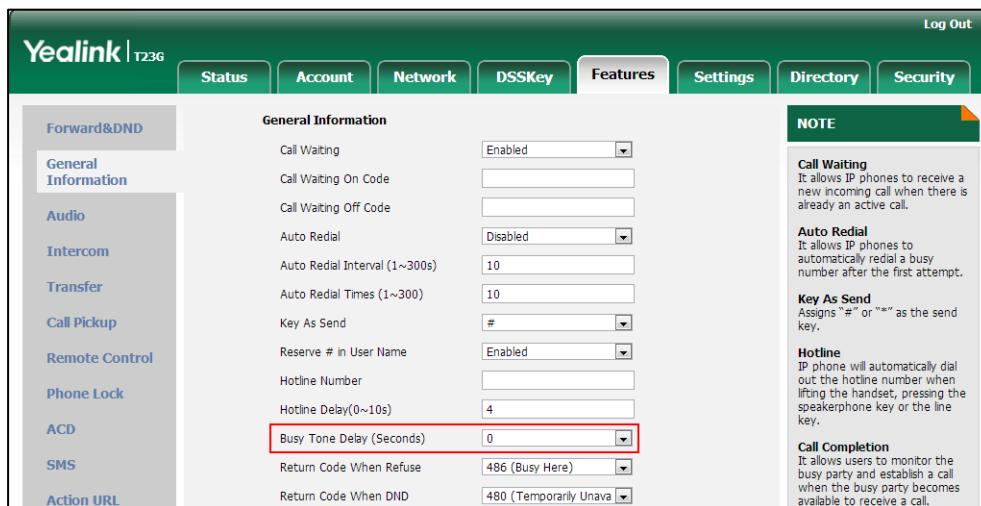

3. Click **Confirm** to accept the change.

Return Code When Refuse

Return code when refuse defines the return code and reason of the SIP response

message for the refused call. The caller's phone LCD screen displays the reason according to the received return code. Available return codes and reasons are:

- 404 (Not Found)
- 480 (Temporarily Unavailable)
- 486 (Busy Here)
- 603 (Decline)

Procedure

Return code for refused call can be configured using the configuration files or locally.

Configuration File	<y0000000000xx>.cfg	Specify the return code and the reason of the SIP response message when refusing a call. Parameter: features.normal_refuse_code
Local	Web User Interface	Specify the return code and the reason of the SIP response message when refusing a call. Navigate to: http://<phoneIPAddress>/servlet?p=features-general&q=load

Details of the Configuration Parameter:

Parameter	Permitted Values	Default
features.normal_refuse_code	404, 480, 486 or 603	486
<p>Description: Configures a return code and reason of SIP response messages when the IP phone rejects an incoming call. A specific reason is displayed on the caller's phone LCD screen.</p> <p>404-Not Found 480-Temporarily Unavailable 486-Busy Here 603-Decline</p> <p>If it is set to 486 (Busy Here), the caller's phone LCD screen will display the message "Busy Here" when the callee rejects the incoming call.</p> <p>Web User Interface: Features->General Information->Return Code When Refuse</p>		

Parameter	Permitted Values	Default
Phone User Interface:		
None		

To specify the return code and the reason when refusing a call via web user interface:

1. Click on **Features->General Information**.
2. Select the desired value from the pull-down list of **Return Code When Refuse**.

The screenshot shows the Yealink T236 web interface with the 'Features' tab selected. Under 'General Information', the 'Return Code When Refuse' dropdown menu is highlighted with a red box, showing the value '486 (Busy Here)'. Other settings include Call Waiting (Enabled), Call Waiting On Code, Call Waiting Off Code, Auto Redial (Disabled), Auto Redial Interval (1~300s) set to 10, Auto Redial Times (1~300) set to 10, Key As Send set to '#', Reserve # in User Name (Enabled), Hotline Number, Hotline Delay (0~10s) set to 4, Busy Tone Delay (Seconds) set to 0, Return Code When DND set to 480 (Temporarily Unavailable), Call Completion (Disabled), Feature Key Synchronization (Disabled), and Time-Out for Dial-Now Rule set to 1. A 'NOTE' section on the right provides details for Call Waiting, Auto Redial, Key As Send, Hotline, and Call Completion.

3. Click **Confirm** to accept the change.

Early Media

Early media refers to media (e.g., audio and video) played to the caller before a SIP call is actually established. Current implementation supports early media through the 183 message. When the caller receives a 183 message with SDP before the call is established, a media channel is established. This channel is used to provide the early media stream for the caller.

180 Ring Workaround

180 ring workaround defines whether to deal with the 180 message received after the 183 message. When the caller receives a 183 message, it suppresses any local ringback tone and begins to play the media received. 180 ring workaround allows IP phones to resume and play the local ringback tone upon a subsequent 180 message received.

Procedure

180 ring workaround can be configured using the configuration files or locally.

Configuration File	<y0000000000xx>.cfg	Configure 180 ring workaround. Parameter: phone_setting.is_deal180
Local	Web User Interface	Configure 180 ring workaround. Navigate to: http://<phoneIPAddress>/servlet ?p=features-general&q=load

Details of the Configuration Parameter:

Parameter	Permitted Values	Default
phone_setting.is_deal180	0 or 1	1
<p>Description: Enables or disables the IP phone to deal with the 180 SIP message received after the 183 SIP message.</p> <p>0-Disabled 1-Enabled</p> <p>If it is set to 1 (Enabled), the IP phone will resume and play the local ringback tone upon a subsequent 180 message received.</p> <p>Web User Interface: Features->General Information->180 Ring Workaround</p> <p>Phone User Interface: None</p>		

To configure 180 ring workaround via web user interface:

1. Click on **Features->General Information**.

- Select the desired value from the pull-down list of **180 Ring Workaround**.

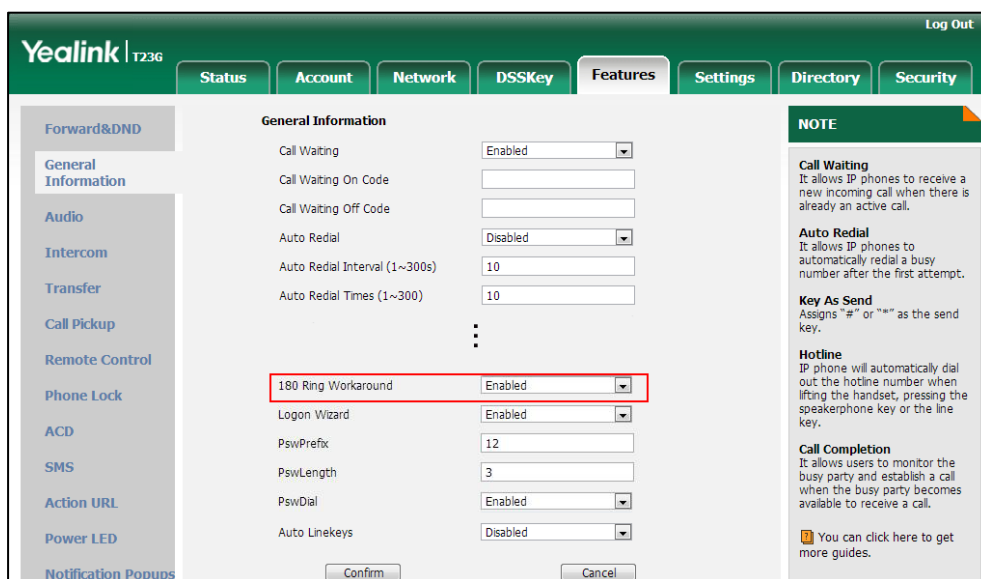

- Click **Confirm** to accept the change.

Use Outbound Proxy in Dialog

An outbound proxy server can receive all initiating request messages and route them to the designated destination. If the IP phone is configured to use an outbound proxy server within a dialog, all SIP request messages from the IP phone will be sent to the outbound proxy server forcibly.

Note To use this feature, make sure the outbound server has been correctly configured on the IP phone. For more information on how to configure outbound server, refer to [Account Registration](#) on page 112.

Procedure

Use outbound proxy in dialog can be configured using the configuration files or locally.

Configuration File	<y0000000000xx>.cfg	Specify whether to use outbound proxy in a dialog. Parameter: sip.use_out_bound_in_dialog
Local	Web User Interface	Specify whether to use outbound proxy in a dialog. Navigate to: http://<phoneIPAddress>/servlet?p=features-general&q=load

Details of the Configuration Parameter:

Parameter	Permitted Values	Default
sip.use_out_bound_in_dialog	0 or 1	1

Description:
 Enables or disables the IP phone to send all SIP requests to the outbound proxy server forcibly in a dialog.

0-Disabled
1-Enabled

If it is set to 0 (Disabled), only the new SIP request messages from the IP phone will be sent to the outbound proxy server in a dialog.

If it is set to 1 (Enabled), all the SIP request messages from the IP phone will be forced to send to the outbound proxy server in a dialog.

Web User Interface:
 Features->General Information->Use Outbound Proxy In Dialog

Phone User Interface:
 None

To configure use outbound proxy in dialog via web user interface:

1. Click on **Features->General Information**.
2. Select the desired value from the pull-down list of **Use Outbound Proxy In Dialog**.

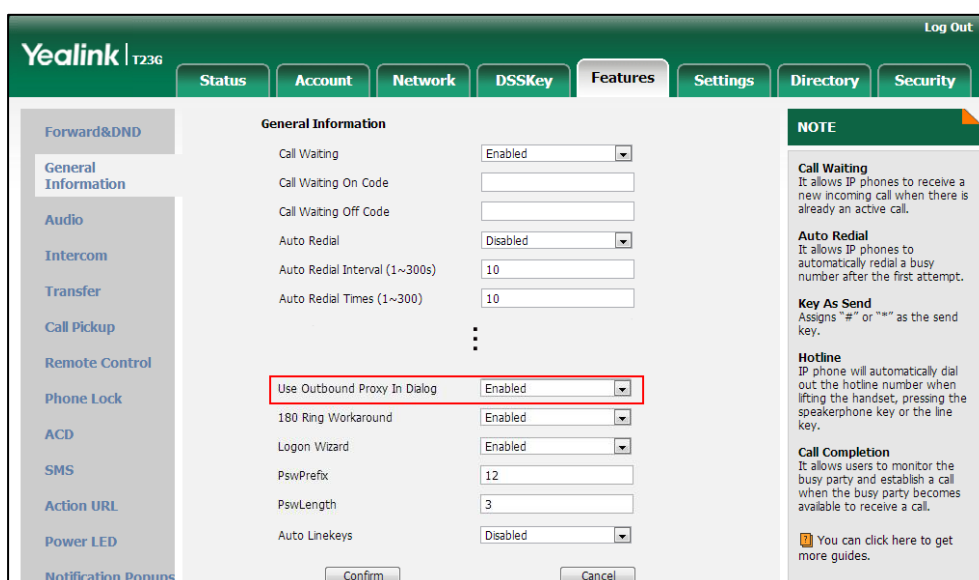

3. Click **Confirm** to accept the change.

SIP Session Timer

SIP session timers T1, T2 and T4 are SIP transaction layer timers defined in [RFC 3261](#). These session timers are configurable on IP phones.

Timer T1

Timer T1 is an estimate of the Round Trip Time (RTT) of transactions between a SIP client and SIP server.

Timer T2

Timer T2 represents the maximum retransmitting time of any SIP request message. The re-transmitting and doubling of T1 will continue until the retransmitting time reaches the T2 value.

Example:

The user registers a SIP account for the IP phone and then set the value of Timer T1, Timer T2 respectively (Timer T1: 0.5, Timer T2: 4). The SIP registration request message will be re-transmitted between the IP phone and SIP server. The re-transmitting and doubling of Timer T1 (0.5) will continue until the retransmitting time reaches the Timer T2 (4). The total registration request retry time will be less than 64 times of T1 ($64 * 0.5 = 32$). The re-transmitting interval in sequence is: 0.5s, 1s, 2s, 4s, 4s, 4s, 4s, 4s and 4s.

Timer T4

Timer T4 represents the time the network will take to clear messages between the SIP client and server.

Procedure

SIP session timer can be configured using the configuration files or locally.

Configuration File	<y0000000000xx>.cfg	Configure SIP session timer. Parameters: sip.timer_t1 sip.timer_t2 sip.timer_t4
Local	Web User Interface	Configure SIP session timer. Navigate to: http://<phoneIPAddress>/servlet ?p=settings-sip&q=load

Details of Configuration Parameters:

Parameters	Permitted Values	Default
sip.timer_t1	Float from 0.5 to 10	0.5
<p>Description: Configures the SIP session timer T1 (in seconds). T1 is an estimate of the Round Trip Time (RTT) of transactions between a SIP client and SIP server.</p> <p>Web User Interface: Settings->SIP->SIP Session Timer T1 (0.5~10s)</p> <p>Phone User Interface: None</p>		
sip.timer_t2	Float from 2 to 40	4
<p>Description: Configures the SIP session timer T2 (in seconds). Timer T2 represents the maximum retransmitting time of any SIP request message.</p> <p>Web User Interface: Settings->SIP->SIP Session Timer T2 (2~40s)</p> <p>Phone User Interface: None</p>		
sip.timer_t4	Float from 2.5 to 60	5
<p>Description: Configures the SIP session timer of T4 (in seconds). T4 represents the maximum duration a message will remain in the network.</p> <p>Web User Interface: Settings->SIP->SIP Session Timer T4 (2.5~60s)</p> <p>Phone User Interface: None</p>		

To configure session timer via web user interface:

1. Click on **Settings->SIP**.
2. Enter the desired value in the **SIP Session Timer T1 (0.5~10s)** field.
The default value is 0.5.
3. Enter the desired value in the **SIP Session Timer T2 (2~40s)** field.

The default value is 4.

4. Enter the desired value in the **SIP Session Timer T4 (2.5~60s)** field.

The default value is 5.

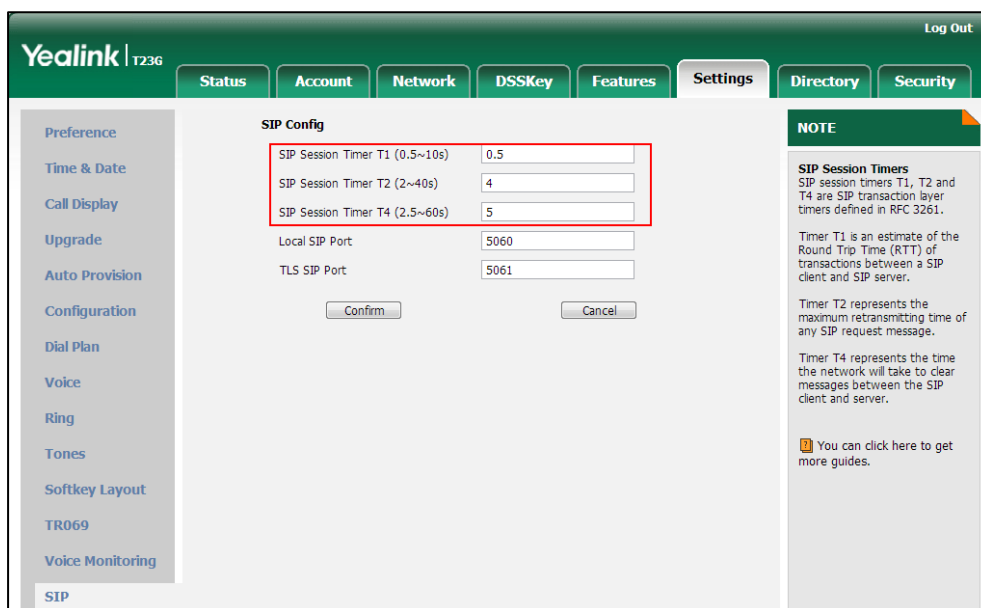

5. Click **Confirm** to accept the change.

Session Timer

Session timer allows a periodic refresh of SIP sessions through a re-INVITE request, to determine whether a SIP session is still active. Session timer is specified in RFC 4028. IP phones support two refresher modes: UAC and UAS. The UAC mode means refreshing the session from the client, while the UAS mode means refreshing the session from the server. The session expiration and session refresher are negotiated via the Session-Expires header in the INVITE message. The negotiated refresher will send a re-INVITE/UPDATE request at or before the negotiated session expiration.

Procedure

Session timer can be configured using the configuration files or locally.

Configuration File	<MAC>.cfg	Configure session timer. Parameters: account.X.session_timer.enable account.X.session_timer.expires account.X.session_timer.refresher
Local	Web User Interface	Configure session timer. Navigate to: http://<phoneIPAddress>/servlet

		?p=account-adv&q=load&acc=0
--	--	-----------------------------

Details of Configuration Parameters:

Parameters	Permitted Values	Default
account.X.session_timer.enable	0 or 1	0
<p>Description: Enables or disables the session timer for account X. 0-Disabled 1-Enabled If it is set to 1 (Enabled), IP phone will send periodic re-INVITE requests to refresh the session during a call. X ranges from 1 to 16 (for SIP-T48G/T46G/T29G) X ranges from 1 to 12 (for SIP-T42G) X ranges from 1 to 6 (for SIP-T41P/T27P) X ranges from 1 to 3 (for SIP-T23P/G) X ranges from 1 to 2 (for SIP-T21(P) E2) X is equal to 1 (for SIP-T19(P) E2)</p> <p>Web User Interface: Account->Advanced->Session Timer</p> <p>Phone User Interface: None</p>		
account.X.session_timer.expires	Integer from 30 to 7200	1800
<p>Description: Configures the interval (in seconds) for refreshing the SIP session during a call for account X. If it is set to 1800 (1800s), the IP phone will refresh the session during a call before 1800 seconds. X ranges from 1 to 16 (for SIP-T48G/T46G/T29G) X ranges from 1 to 12 (for SIP-T42G) X ranges from 1 to 6 (for SIP-T41P/T27P) X ranges from 1 to 3 (for SIP-T23P/G) X ranges from 1 to 2 (for SIP-T21(P) E2) X is equal to 1 (for SIP-T19(P) E2)</p>		

Parameters	Permitted Values	Default
<p>Example: account.1.session_timer.expires = 1800</p> <p>Web User Interface: Account->Advanced->Session Expires(30~7200s)</p> <p>Phone User Interface: None</p>		
account.X.session_timer.refresher	0 or 1	0
<p>Description: Configures the refresher of the session timer for account X.</p> <p>0-UAC (Refreshing the session is performed by the IP phone) 1-UAS (Refreshing the session is performed by a SIP server)</p> <p>X ranges from 1 to 16 (for SIP-T48G/T46G/T29G) X ranges from 1 to 12 (for SIP-T42G) X ranges from 1 to 6 (for SIP-T41P/T27P) X ranges from 1 to 3 (for SIP-T23P/G) X ranges from 1 to 2 (for SIP-T21(P) E2) X is equal to 1 (for SIP-T19(P) E2)</p> <p>Web User Interface: Account->Advanced->Session Refresher</p> <p>Phone User Interface: None</p>		

To configure session timer via web user interface:

1. Click on **Account->Advanced**.
2. Select the desired account from the pull-down list of **Account**.
3. Select the desired value from the pull-down list of **Session Timer**.
4. Enter the desired time interval in the **Session Expires(30~7200s)** field.

- Select the desired refresher from the pull-down list of **Session Refresher**.

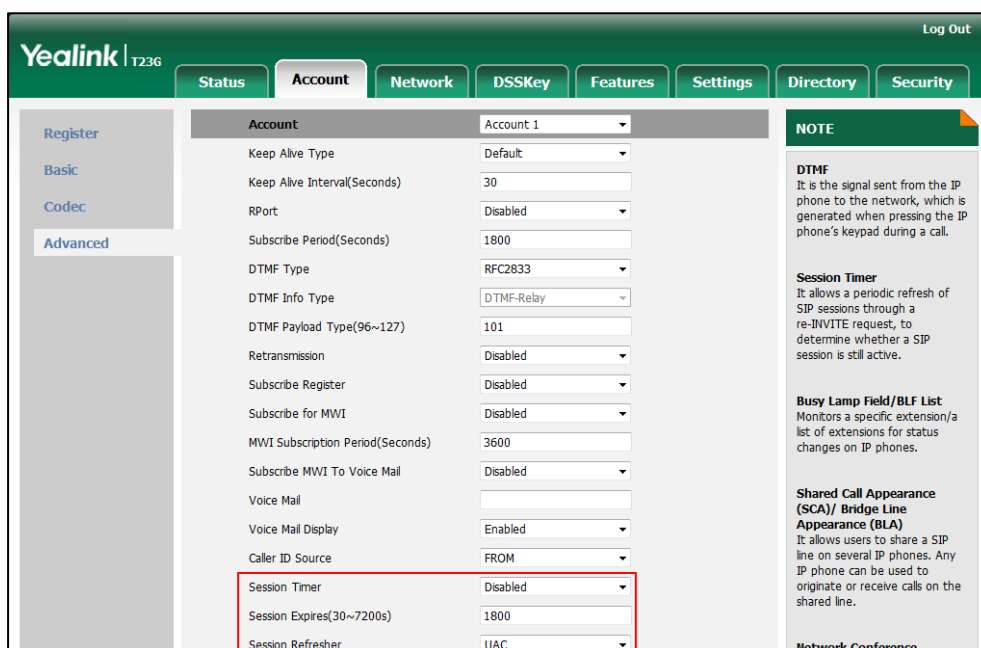

- Click **Confirm** to accept the change.

Call Hold

Call hold provides a service of placing an active call on hold. When a call is placed on hold, the IP phones send an INVITE request with HOLD SDP to request remote parties to stop sending media and to inform them that they are being held. IP phones support two call hold methods, one is RFC 3264, which sets the “a” (media attribute) in the SDP to sendonly, recvonly or inactive (e.g., a=sendonly). The other is RFC 2543, which sets the “c” (connection addresses for the media streams) in the SDP to zero (e.g., c=0.0.0.0). Call hold tone allows IP phones to play a warning tone at regular intervals when there is a call on hold. The warning tone is played through the speakerphone.

Procedure

Call hold can be configured using the configuration files or locally.

<p>Configuration File</p>	<p><y0000000000xx>.cfg</p>	<p>Configure the call hold tone and call hold tone delay.</p> <p>Parameters:</p> <p>features.play_hold_tone.enable</p> <p>features.play_hold_tone.delay</p> <p>Specify whether RFC 2543 (c=0.0.0.0) outgoing hold signaling is used.</p> <p>Parameter:</p>
----------------------------------	----------------------------------	--

		sip.rfc2543_hold
Local	Web User Interface	<p>Configure the call hold tone and call hold tone delay.</p> <p>Specify whether RFC 2543 (c=0.0.0.0) outgoing hold signaling is used.</p> <p>Navigate to: <a href="http://<phoneIPAddress>/servlet?p=features-general&q=load">http://<phoneIPAddress>/servlet?p=features-general&q=load</p>

Details of Configuration Parameters:

Parameters	Permitted Values	Default
features.play_hold_tone.enable	0 or 1	1
<p>Description: Enables or disables the IP phone to play a warning tone when there is a call on hold. 0-Disabled 1-Enabled</p> <p>Web User Interface: Features->General Information->Play Hold Tone</p> <p>Phone User Interface: None</p>		
features.play_hold_tone.delay	Integer from 3 to 3600	30
<p>Description: Configures the interval (in seconds) at which the IP phone play a warning tone when there is a call on hold. If it is set to 30 (30s), the IP phone will play a warning tone every 30 seconds when there is a call on hold.</p> <p>Note: It works only if the value of the parameter "features.play_hold_tone.enable" is set to 1 (Enabled).</p> <p>Web User Interface: Features->General Information->Play Hold Tone Delay</p> <p>Phone User Interface: None</p>		
sip.rfc2543_hold	0 or 1	0

Parameters	Permitted Values	Default
<p>Description: Enables or disables the IP phone to use RFC 2543 (c=0.0.0.0) outgoing hold signaling. 0-Disabled 1-Enabled If it is set to 0 (Disabled), SDP media direction attributes (such as a=sendonly) per RFC 3264 is used when placing a call on hold. If it is set to 1 (Enabled), SDP media connection address c=0.0.0.0 per RFC 2543 is used when placing a call on hold.</p> <p>Web User Interface: Features->General Information->RFC 2543 Hold</p> <p>Phone User Interface: None</p>		

To configure call hold tone and call hold tone delay via web user interface:

1. Click on **Features->General Information**.
2. Select the desired value from the pull-down list of **Play Hold Tone**.
3. Enter the desired time in the **Play Hold Tone Delay** field.

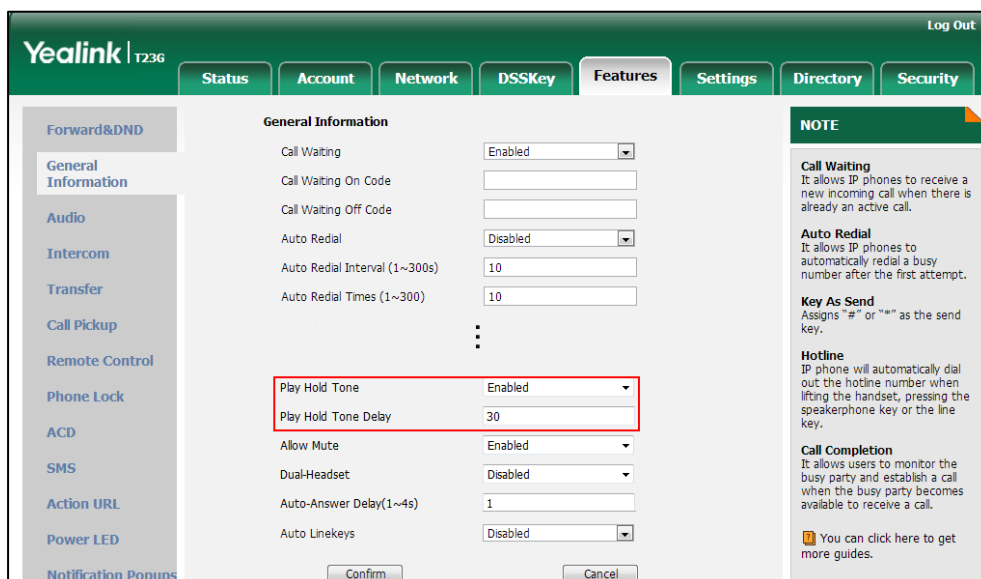

4. Click **Confirm** to accept the change.

To configure call hold method via web user interface:

1. Click on **Features->General Information**.

- Select the desired value from the pull-down list of **RFC 2543 Hold**.

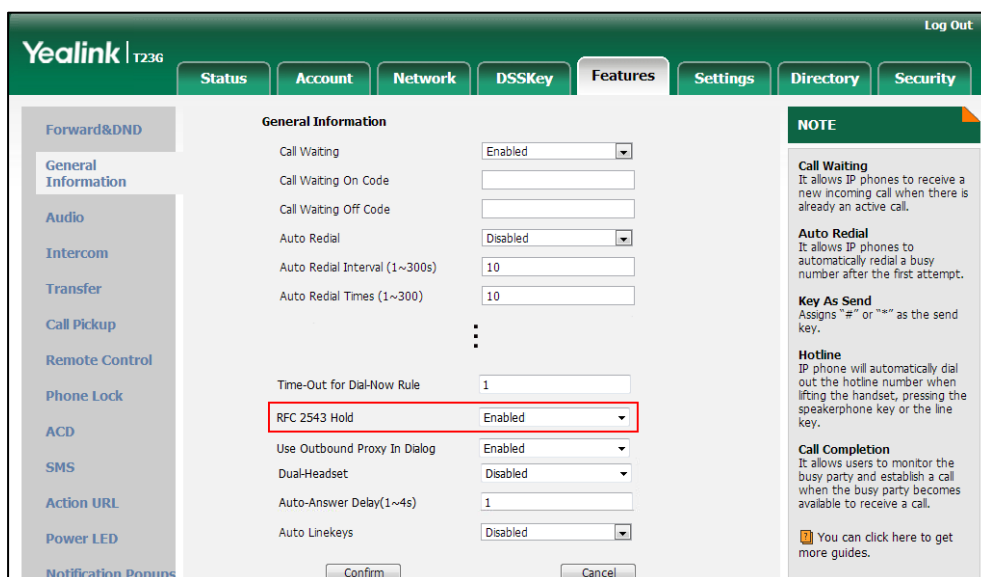

- Click **Confirm** to accept the change.

Music on Hold

Music on Hold (MoH) is the business practice of playing recorded music to fill the silence that would be heard by the party who has been placed on hold. To use this feature, specify a SIP URI pointing to a MoH server account. When a call is placed on hold, the IP phone will send an INVITE message to the specified MoH server account according to the SIP URI. The MoH server account automatically responds to the INVITE message and immediately plays audio from some source located anywhere (LAN, Internet) to the held party.

Note Music on Hold is not available on all servers. It is no need to specify the SIP URI if the MoH feature is enabled by default on the server and the server can play audio to the held party. For more information, contact your server administrator.

Procedure

Music on hold can be configured using the configuration files or locally.

<p>Configuration File</p>	<p><MAC>.cfg</p>	<p>Configure music on hold on a per-line basis.</p> <p>Parameter:</p> <p>account.X.music_server_uri</p> <p>Configure the way on how the IP phone processes music on hold when placing an active call on</p>
----------------------------------	------------------------	--

		hold. Parameter: account.X.music_on_hold_type
Local	Web User Interface	Configure music on hold on a per-line basis. Navigate to: http://<phoneIPAddress>/servlet?p=account-adv&q=load&acc=0

Details of Configuration Parameters:

Parameters	Permitted Values	Default
account.X.music_server_uri	SIP URI within 256 characters	Blank
<p>Description: Configures the address of the Music On Hold server for account X. Examples for valid values: <10.1.3.165>, 10.1.3.165, sip:moh@sip.com, <sip:moh@sip.com>, <yealink.com> or yealink.com. X ranges from 1 to 16 (for SIP-T48G/T46G/T29G) X ranges from 1 to 12 (for SIP-T42G) X ranges from 1 to 6 (for SIP-T41P/T27P) X ranges from 1 to 3 (for SIP-T23P/G) X ranges from 1 to 2 (for SIP-T21(P) E2) X is equal to 1 (for SIP-T19(P) E2)</p> <p>Example: account.1.music_server_uri = sip:moh@sip.com</p> <p>Note: The DNS query in this parameter only supports A query.</p> <p>Web User Interface: Account->Advanced->Music Server URI</p> <p>Phone User Interface: None</p>		
account.X.music_on_hold_type	0 or 1	0
<p>Description: Configures the way to process Music On Hold when placing an active call on hold for account X.</p>		

Parameters	Permitted Values	Default
<p>0-Calling the Music On Hold server before holding</p> <p>1-Calling the Music On Hold server after holding</p> <p>X ranges from 1 to 16 (for SIP-T48G/T46G/T29G)</p> <p>X ranges from 1 to 12 (for SIP-T42G)</p> <p>X ranges from 1 to 6 (for SIP-T41P/T27P)</p> <p>X ranges from 1 to 3 (for SIP-T23P/G)</p> <p>X ranges from 1 to 2 (for SIP-T21(P) E2)</p> <p>X is equal to 1 (for SIP-T19(P) E2)</p> <p>Web User Interface:</p> <p>None</p> <p>Phone User Interface:</p> <p>None</p>		

To configure MoH via web user interface:

1. Click on **Account->Advanced**.
2. Select the desired account from the pull-down list of **Account**.
3. Enter the SIP URI (e.g., sip:moh@sip.com) in the **Music Server URI** field.

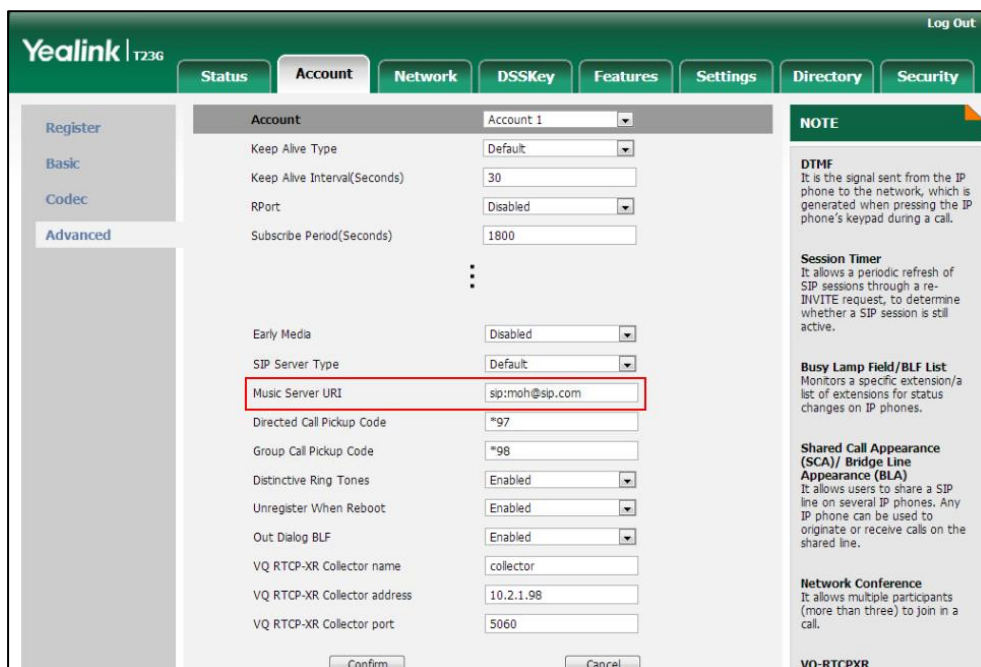

4. Click **Confirm** to accept the change.

Call Forward

Call forward allows users to redirect an incoming call to a third party. IP phones redirect an incoming INVITE message by responding with a 302 Moved Temporarily message, which contains a Contact header with a new URI that should be tried. Three types of call forward:

- **Always Forward** -- Forward the incoming call immediately.
- **Busy Forward** -- Forward the incoming call when the IP phone or the specified account is busy.
- **No Answer Forward** -- Forward the incoming call after a period of ring time.

Call forward can be configured on a phone or a per-line basis depending on the call forward mode. The following describes the call forward modes:

- **Phone** (default): Call forward feature is effective for the IP phone.
- **Custom**: Call forward feature can be configured for each or all accounts.

The server-side call forward settings disable the local call forward settings. If the server-side call forward feature is enabled on any of the IP phone's registrations, the other registrations are not affected. DND activated on the IP phone disables the local no answer forward settings.

The call forward on code and call forward off code configured on IP phones are used to activate/deactivate the server-side call forward feature. They may vary on different servers.

Diversion/History-Info

IP phones support the redirected call information sent by the SIP server with Diversion header, per draft-levy-sip-diversion-08, or History-info header, per RFC 4244. The Diversion/History-info header is used to inform the IP phone of a call's history. For example, when a phone has been set to enable call forward, the Diversion/History-info header allows the receiving phone to indicate who the call was from, and from which phone number it was forwarded.

Forward International

Forward international allows users to forward an incoming call to an international telephone number. This feature is enabled by default.

Forward Emergency

Forward emergency allows the incoming calls from some authorized numbers not to be forwarded when the call forward feature is enabled. The incoming call will not be logged in the Forwarded Calls list. This feature is disabled by default.

Procedure

Call forward can be configured using the configuration files or locally.

	<p><MAC>.cfg</p>	<p>Configure call forward in custom mode.</p> <p>Parameters:</p> <p>account.X.always_fwd.enable account.X.always_fwd.target account.X.always_fwd.on_code account.X.always_fwd.off_code account.X.busy_fwd.enable account.X.busy_fwd.target account.X.busy_fwd.on_code account.X.busy_fwd.off_code account.X.timeout_fwd.enable account.X.timeout_fwd.target account.X.timeout_fwd.timeout account.X.timeout_fwd.on_code account.X.timeout_fwd.off_code</p>
<p>Configuration File</p>	<p><y0000000000xx>.cfg</p>	<p>Specify the authorized numbers when call forward is enabled.</p> <p>Parameters:</p> <p>features.forward.emergency.enable features.forward.emergency.authorized_number</p> <p>Configure the call forward mode.</p> <p>Parameter:</p> <p>features.fwd_mode</p> <p>Configure call forward in phone mode.</p> <p>Parameters:</p> <p>forward.always.enable forward.always.target forward.always.on_code forward.always.off_code forward.busy.enable</p>

		<p>forward.busy.target forward.busy.on_code forward.busy.off_code forward.no_answer.enable forward.no_answer.target forward.no_answer.timeout forward.no_answer.on_code forward.no_answer.off_code</p> <p>Configure diversion/history-info feature.</p> <p>Parameter: features.fwd_diversion_enable</p> <p>Configure forward international.</p> <p>Parameter: forward.international.enable</p>
Local	Web User Interface	<p>Specify the authorized numbers when call forward is enabled.</p> <p>Configure call forward.</p> <p>Navigate to: http://<phoneIPAddress>/servlet?p=features-forward&q=load</p> <p>Configure diversion/history-info feature.</p> <p>Configure forward international.</p> <p>Navigate to: http://<phoneIPAddress>/servlet?p=features-general&q=load</p>
	Phone User Interface	<p>Configure call forward.</p> <p>Configure forward international.</p>

Details of Configuration Parameters:

Parameters	Permitted Values	Default
features.fwd_mode	0 or 1	0
<p>Description: Configures the call forward mode for the IP phone.</p> <p>0-Phone</p>		

Parameters	Permitted Values	Default
<p>1-Custom</p> <p>If it is set to 0 (Phone), call forward feature is effective for the IP phone.</p> <p>If it is set to 1 (Custom), you can configure call forward feature for each account.</p> <p>Note: It is not applicable to SIP-T19(P) E2 IP phones.</p> <p>Web User Interface:</p> <p>Features->Forward&DND->Forward->Mode</p> <p>Phone User Interface:</p> <p>None</p>		
account.X.always_fwd.enable	0 or 1	0
<p>Description:</p> <p>Triggers always forward feature to on or off for account X.</p> <p>0-Off</p> <p>1-On</p> <p>If it is set to 1 (On), incoming calls to the account X are forwarded to the destination number immediately.</p> <p>X ranges from 1 to 16 (for SIP-T48G/T46G/T29G)</p> <p>X ranges from 1 to 12 (for SIP-T42G)</p> <p>X ranges from 1 to 6 (for SIP-T41P/T27P)</p> <p>X ranges from 1 to 3 (for SIP-T23P/G)</p> <p>X ranges from 1 to 2 (for SIP-T21(P) E2)</p> <p>Note: It works only if the value of the parameter “features.fwd_mode” is set to 1 (Custom). It is not applicable to SIP-T19(P) E2 IP phones.</p> <p>Web User Interface:</p> <p>Features->Forward&DND->Forward->Always Forward->On/Off</p> <p>Phone User Interface:</p> <p>Menu->Features->Call Forward->Always Forward->Always Forward</p>		
account.X.always_fwd.target	String within 32 characters	Blank
<p>Description:</p> <p>Configures the destination number of the always forward for account X.</p> <p>X ranges from 1 to 16 (for SIP-T48G/T46G/T29G)</p> <p>X ranges from 1 to 12 (for SIP-T42G)</p> <p>X ranges from 1 to 6 (for SIP-T41P/T27P)</p> <p>X ranges from 1 to 3 (for SIP-T23P/G)</p>		

Parameters	Permitted Values	Default
<p>X ranges from 1 to 2 (for SIP-T21(P) E2)</p> <p>Note: It works only if the value of the parameter "features.fwd_mode" is set to 1 (Custom). It is not applicable to SIP-T19(P) E2 IP phones.</p> <p>Example:</p> <p>account.1.always_fwd.target = 1003</p> <p>Web User Interface:</p> <p>Features->Forward&DND->Forward->Always Forward->Target</p> <p>Phone User Interface:</p> <p>Menu->Features->Call Forward->Always Forward->Forward to</p>		
account.X.always_fwd.on_code	String within 32 characters	Blank
<p>Description:</p> <p>Configures the always forward on code to activate the server-side always forward feature for account X. The IP phone will send the always forward on code and the pre-configured destination number to the server when you activate always forward feature for account X on the IP phone.</p> <p>X ranges from 1 to 16 (for SIP-T48G/T46G/T29G)</p> <p>X ranges from 1 to 12 (for SIP-T42G)</p> <p>X ranges from 1 to 6 (for SIP-T41P/T27P)</p> <p>X ranges from 1 to 3 (for SIP-T23P/G)</p> <p>X ranges from 1 to 2 (for SIP-T21(P) E2)</p> <p>Example:</p> <p>account.1.always_fwd.on_code = *72</p> <p>Note: It works only if the value of the parameter "features.fwd_mode" is set to 1 (Custom). It is not applicable to SIP-T19(P) E2 IP phones.</p> <p>Web User Interface:</p> <p>Features->Forward&DND->Forward->Always Forward->On Code</p> <p>Phone User Interface:</p> <p>Menu->Features->Call Forward->Always Forward->On Code</p>		
account.X.always_fwd.off_code	String within 32 characters	Blank
<p>Description:</p> <p>Configures the always forward off code to deactivate the server-side always forward feature for account X. The IP phone will send the always forward off code to the server when you deactivate always forward feature for account X on the IP</p>		

Parameters	Permitted Values	Default
<p>phone.</p> <p>X ranges from 1 to 16 (for SIP-T48G/T46G/T29G)</p> <p>X ranges from 1 to 12 (for SIP-T42G)</p> <p>X ranges from 1 to 6 (for SIP-T41P/T27P)</p> <p>X ranges from 1 to 3 (for SIP-T23P/G)</p> <p>X ranges from 1 to 2 (for SIP-T21(P) E2)</p> <p>Example:</p> <p>account.1.always_fwd.off_code = *73</p> <p>Note: It works only if the value of the parameter "features.fwd_mode" is set to 1 (Custom). It is not applicable to SIP-T19(P) E2 IP phones.</p> <p>Web User Interface:</p> <p>Features->Forward&DND->Forward->Always Forward->Off Code</p> <p>Phone User Interface:</p> <p>Menu->Features->Call Forward->Always Forward->Off Code</p>		
account.X.busy_fwd.enable	0 or 1	0
<p>Description:</p> <p>Triggers busy forward feature to on or off for account X.</p> <p>0-Off</p> <p>1-On</p> <p>If it is set to 1 (On), incoming calls to the account X are forwarded to the destination number when the callee is busy.</p> <p>X ranges from 1 to 16 (for SIP-T48G/T46G/T29G)</p> <p>X ranges from 1 to 12 (for SIP-T42G)</p> <p>X ranges from 1 to 6 (for SIP-T41P/T27P)</p> <p>X ranges from 1 to 3 (for SIP-T23P/G)</p> <p>X ranges from 1 to 2 (for SIP-T21(P) E2)</p> <p>Note: It works only if the value of the parameter "features.fwd_mode" is set to 1 (Custom). It is not applicable to SIP-T19(P) E2 IP phones.</p> <p>Web User Interface:</p> <p>Features->Forward&DND->Forward->Busy Forward->On/Off</p> <p>Phone User Interface:</p> <p>Menu->Features->Call Forward->Busy Forward->Busy Forward</p>		
account.X.busy_fwd.target	String within 32 characters	Blank

Parameters	Permitted Values	Default
<p>Description: Configures the destination number of the busy forward for account X. X ranges from 1 to 16 (for SIP-T48G/T46G/T29G) X ranges from 1 to 12 (for SIP-T42G) X ranges from 1 to 6 (for SIP-T41P/T27P) X ranges from 1 to 3 (for SIP-T23P/G) X ranges from 1 to 2 (for SIP-T21(P) E2)</p> <p>Example: account.1.busy_fwd.target = 3602</p> <p>Note: It works only if the value of the parameter "features.fwd_mode" is set to 1 (Custom). It is not applicable to SIP-T19(P) E2 IP phones.</p> <p>Web User Interface: Features->Forward&DND->Forward->Busy Forward->Target</p> <p>Phone User Interface: Menu->Features->Call Forward->Busy Forward->Forward to</p>		
account.X.busy_fwd.on_code	String within 32 characters	Blank
<p>Description: Configures the busy forward on code to activate the server-side busy forward feature for account X. The IP phone will send the busy forward on code and the pre-configured destination number to the server when you activate busy forward feature for account X on the IP phone. X ranges from 1 to 16 (for SIP-T48G/T46G/T29G) X ranges from 1 to 12 (for SIP-T42G) X ranges from 1 to 6 (for SIP-T41P/T27P) X ranges from 1 to 3 (for SIP-T23P/G) X ranges from 1 to 2 (for SIP-T21(P) E2)</p> <p>Example: account.1.busy_fwd.on_code = *74</p> <p>Note: It works only if the value of the parameter "features.fwd_mode" is set to 1 (Custom). It is not applicable to SIP-T19(P) E2 IP phones.</p> <p>Web User Interface: Features->Forward&DND->Forward->No Answer Forward->On Code</p> <p>Phone User Interface: Menu->Features->Call Forward->Busy Forward->On Code</p>		

Parameters	Permitted Values	Default
account.X.busy_fwd.off_code	String within 32 characters	Blank
<p>Description:</p> <p>Configures the busy forward off code to deactivate the server-side busy forward feature for account X. The IP phone will send the busy forward off code to the server when you deactivate busy forward feature for account X on the IP phone.</p> <p>X ranges from 1 to 16 (for SIP-T48G/T46G/T29G)</p> <p>X ranges from 1 to 12 (for SIP-T42G)</p> <p>X ranges from 1 to 6 (for SIP-T41P/T27P)</p> <p>X ranges from 1 to 3 (for SIP-T23P/G)</p> <p>X ranges from 1 to 2 (for SIP-T21(P) E2)</p> <p>Example:</p> <p>account.1.busy_fwd.off_code = *75</p> <p>Note: It works only if the value of the parameter “features.fwd_mode” is set to 1 (Custom). It is not applicable to SIP-T19(P) E2 IP phones.</p> <p>Web User Interface:</p> <p>Features->Forward&DND->Forward->No Answer Forward->Off Code</p> <p>Phone User Interface:</p> <p>Menu->Features->Call Forward->Busy Forward->Off Code</p>		
account.X.timeout_fwd.enable	0 or 1	0
<p>Description:</p> <p>Triggers no answer forward feature to on or off for account X.</p> <p>0-Off</p> <p>1-On</p> <p>If it is set to 1 (On), incoming calls to the account X are forwarded to the destination number after a period of ring time.</p> <p>X ranges from 1 to 16 (for SIP-T48G/T46G/T29G)</p> <p>X ranges from 1 to 12 (for SIP-T42G)</p> <p>X ranges from 1 to 6 (for SIP-T41P/T27P)</p> <p>X ranges from 1 to 3 (for SIP-T23P/G)</p> <p>X ranges from 1 to 2 (for SIP-T21(P) E2)</p> <p>Note: It works only if the value of the parameter “features.fwd_mode” is set to 1 (Custom). It is not applicable to SIP-T19(P) E2 IP phones.</p> <p>Web User Interface:</p>		

Parameters	Permitted Values	Default
Features->Forward&DND->Forward->No Answer Forward->On/Off Phone User Interface: Menu->Features->Call Forward->No Answer Forward->No Answer Forward		
account.X.timeout_fwd.target	String within 32 characters	Blank
Description: Configures the destination number of the no answer forward for account X. X ranges from 1 to 16 (for SIP-T48G/T46G/T29G) X ranges from 1 to 12 (for SIP-T42G) X ranges from 1 to 6 (for SIP-T41P/T27P) X ranges from 1 to 3 (for SIP-T23P/G) X ranges from 1 to 2 (for SIP-T21(P) E2) Example: account.1.timeout_fwd.target = 3603 Note: It works only if the value of the parameter "features.fwd_mode" is set to 1 (Custom). It is not applicable to SIP-T19(P) E2 IP phones. Web User Interface: Features->Forward&DND->Forward->No Answer Forward->Target Phone User Interface: Menu->Features->Call Forward->No Answer Forward->Forward to		
account.X.timeout_fwd.timeout	Integer from 0 to 20	2
Description: Configures ring times (N) to wait before forwarding incoming calls for account X. Incoming calls will be forwarded when not answered after N*6 seconds. X ranges from 1 to 16 (for SIP-T48G/T46G/T29G) X ranges from 1 to 12 (for SIP-T42G) X ranges from 1 to 6 (for SIP-T41P/T27P) X ranges from 1 to 3 (for SIP-T23P/G) X ranges from 1 to 2 (for SIP-T21(P) E2) Note: It works only if the value of the parameter "features.fwd_mode" is set to 1 (Custom). It is not applicable to SIP-T19(P) E2 IP phones. Web User Interface: Features->Forward&DND->Forward->No Answer Forward->After Ring		

Parameters	Permitted Values	Default
Time(0~120s) Phone User Interface: Menu->Features->Call Forward->No Answer Forward->After Ring Time		
account.X.timeout_fwd.on_code	String within 32 characters	Blank
Description: Configures the no answer forward on code to activate the server-side no answer forward feature for account X. The IP phone will send the no answer forward on code and the pre-configured destination number to the server when you activate no answer forward feature for account X on the IP phone. X ranges from 1 to 16 (for SIP-T48G/T46G/T29G) X ranges from 1 to 12 (for SIP-T42G) X ranges from 1 to 6 (for SIP-T41P/T27P) X ranges from 1 to 3 (for SIP-T23P/G) X ranges from 1 to 2 (for SIP-T21(P) E2) Example: account.1.timeout_fwd.on_code = *76 Note: It works only if the value of the parameter "features.fwd_mode" is set to 1 (Custom). It is not applicable to SIP-T19(P) E2 IP phones. Web User Interface: Features->Forward&DND->Forward->No Answer Forward->On Code Phone User Interface: Menu->Features->Call Forward->No Answer Forward->On Code		
account.X.timeout_fwd.off_code	String within 32 characters	Blank
Description: Configures the no answer forward off code to deactivate the server-side no answer forward feature for account X. The IP phone will send the no answer forward off code to the server when you deactivate no answer forward feature for account X on the IP phone. X ranges from 1 to 16 (for SIP-T48G/T46G/T29G) X ranges from 1 to 12 (for SIP-T42G) X ranges from 1 to 6 (for SIP-T41P/T27P) X ranges from 1 to 3 (for SIP-T23P/G) X ranges from 1 to 2 (for SIP-T21(P) E2)		

Parameters	Permitted Values	Default
<p>Example: account.1.timeout_fwd.off_code = *77</p> <p>Note: It works only if the value of the parameter "features.fwd_mode" is set to 1 (Custom). It is not applicable to SIP-T19(P) E2 IP phones.</p> <p>Web User Interface: Features->Forward&DND->Forward->No Answer Forward ->Off Code</p> <p>Phone User Interface: Menu->Features->Call Forward->No Answer Forward->Off Code</p>		
features.forward.emergency.enable	0 or 1	0
<p>Description: Enables or disables the incoming calls from some authorized numbers not to be forwarded when the call forward feature is enabled.</p> <p>0-Disabled 1-Enabled</p> <p>Web User Interface: Features->Forward&DND->Forward->Forward Emergency</p> <p>Phone User Interface: None</p>		
features.forward.emergency.authorized_number	String within 511 characters	Blank
<p>Description: Configures the authorized numbers not to be forwarded even if call forward feature is enabled.</p> <p>Multiple numbers are separated by commas.</p> <p>Example: features.forward.emergency.authorized_number = 123,124</p> <p>Note: It works only if the value of the parameter "features.forward.emergency.enable" is set to 1 (Enabled).</p> <p>Web User Interface: Features->Forward&DND->Forward->Forward Authorized Numbers</p> <p>Phone User Interface: None</p>		
forward.always.enable	0 or 1	0

Parameters	Permitted Values	Default
<p>Description: Triggers the always forward feature to on or off.</p> <p>0-Off 1-On</p> <p>If it is set to 1 (On), incoming calls are forwarded to the destination number immediately.</p> <p>Note: For Yealink IP phones (except SIP-T19(P) E2), it works only if the value of the parameter "features.fwd_mode" is set to 0 (Phone).</p> <p>Web User Interface: Features->Forward&DND->Forward->Always Forward->On/Off</p> <p>Phone User Interface: Menu->Features->Call Forward->Always Forward->Always Forward</p>		
forward.always.target	String within 32 characters	Blank
<p>Description: Configures the destination number of the always forward for the IP phone.</p> <p>Note: For Yealink IP phones (except SIP-T19(P) E2), it works only if the value of the parameter "features.fwd_mode" is set to 0 (Phone).</p> <p>Web User Interface: Features->Forward&DND->Forward->Always Forward->Target</p> <p>Phone User Interface: Menu->Features->Call Forward->Always Forward->Forward to</p>		
forward.always.on_code	String within 32 characters	Blank
<p>Description: Configures the always forward on code to activate the server-side always forward feature. The IP phone will send the always forward on code and the pre-configured destination number to the server when you activate always forward feature on the IP phone.</p> <p>Example: forward.always.on_code = *72</p> <p>Note: For Yealink IP phones (except SIP-T19(P) E2), it works only if the value of the parameter "features.fwd_mode" is set to 0 (Phone).</p> <p>Web User Interface: Features->Forward&DND->Forward->Always Forward->On Code</p>		

Parameters	Permitted Values	Default
<p>Phone User Interface: Menu->Features->Call Forward->Always Forward->On Code</p>		
forward.always.off_code	String within 32 characters	Blank
<p>Description: Configures the always forward off code to deactivate the server-side always forward feature. The IP phone will send the always forward off code to the server when you deactivate always forward feature on the IP phone.</p> <p>Example: forward.always.off_code = *73</p> <p>Note: For Yealink IP phones (except SIP-T19(P) E2), it works only if the value of the parameter "features.fwd_mode" is set to 0 (Phone).</p> <p>Web User Interface: Features->Forward&DND->Forward->Always Forward->Off Code</p> <p>Phone User Interface: Menu->Features->Call Forward->Always Forward->Off Code</p>		
forward.busy.enable	0 or 1	0
<p>Description: Triggers the busy forward feature to on or off.</p> <p>0-Off 1-On</p> <p>If it is set to 1 (On), incoming calls are forwarded to the destination number when the callee is busy.</p> <p>Note: For Yealink IP phones (except SIP-T19(P) E2), it works only if the value of the parameter "features.fwd_mode" is set to 0 (Phone).</p> <p>Web User Interface: Features->Forward&DND->Forward->Busy Forward->On/Off</p> <p>Phone User Interface: Menu->Features->Call Forward->Busy Forward->Busy Forward</p>		
forward.busy.target	String within 32 characters	Blank

Parameters	Permitted Values	Default
<p>Description: Configures the destination number of the busy forward for the IP phone.</p> <p>Example: forward.busy.target = 3602</p> <p>Note: For Yealink IP phones (except SIP-T19(P) E2), it works only if the value of the parameter "features.fwd_mode" is set to 0 (Phone).</p> <p>Web User Interface: Features->Forward&DND->Forward->Busy Forward->Target</p> <p>Phone User Interface: Menu->Features->Call Forward-> Busy Forward->Forward to</p>		
forward.busy.on_code	String within 32 characters	Blank
<p>Description: Configures the busy forward on code to activate the server-side busy forward feature. The IP phone will send the busy forward on code and the pre-configured destination number to the server when you activate busy forward feature on the IP phone.</p> <p>Example: forward.busy.on_code = *74</p> <p>Note: For Yealink IP phones (except SIP-T19(P) E2), it works only if the value of the parameter "features.fwd_mode" is set to 0 (Phone).</p> <p>Web User Interface: Features->Forward&DND->Forward->Busy Forward->On Code</p> <p>Phone User Interface: Menu->Features->Call Forward->Busy Forward->On Code</p>		
forward.busy.off_code	String within 32 characters	Blank
<p>Description: Configures the busy forward off code to deactivate the server-side busy forward feature. The IP phone will send the busy forward off code to the server when you deactivate busy forward feature on the IP phone.</p> <p>Example: forward.busy.off_code = *75</p> <p>Note: For Yealink IP phones (except SIP-T19(P) E2), it works only if the value of the parameter "features.fwd_mode" is set to 0 (Phone).</p>		

Parameters	Permitted Values	Default
<p>Web User Interface: Features->Forward&DND->Forward->Busy Forward->Off Code</p> <p>Phone User Interface: Menu->Features->Call Forward->Busy Forward->Off Code</p>		
forward.no_answer.enable	0 or 1	0
<p>Description: Triggers the no answer forward feature to on or off.</p> <p>0-Off 1-On</p> <p>If it is set to 1 (On), incoming calls are forwarded to the destination number after a period of ring time.</p> <p>Note: For Yealink IP phones (except SIP-T19(P) E2), it works only if the value of the parameter "features.fwd_mode" is set to 0 (Phone).</p> <p>Web User Interface: Features->Forward&DND->Forward->No Answer Forward->On/Off</p> <p>Phone User Interface: Menu->Features->Call Forward->No Answer Forward->No Answer Forward</p>		
forward.no_answer.target	String within 32 characters	Blank
<p>Description: Configures the destination number of the no answer forward for the IP phone.</p> <p>Example: forward.no_answer.target = 3603</p> <p>Note: For Yealink IP phones (except SIP-T19(P) E2), it works only if the value of the parameter "features.fwd_mode" is set to 0 (Phone).</p> <p>Web User Interface: Features->Forward&DND->Forward->No Answer Forward->Target</p> <p>Phone User Interface: Menu->Features->Call Forward->No Answer Forward->Forward to</p>		
forward.no_answer.timeout	Integer from 0 to 20	2

Parameters	Permitted Values	Default
<p>Description: Configures ring times (N) to wait before forwarding incoming calls. Incoming calls will be forwarded when not answered after N*6 seconds. Note: For Yealink IP phones (except SIP-T19(P) E2), it works only if the value of the parameter “features.fwd_mode” is set to 0 (Phone). Web User Interface: Features->Forward&DND->Forward->No Answer Forward->After Ring Time (0~120s) Phone User Interface: Menu->Features->Call Forward->No Answer Forward->After Ring Time</p>		
forward.no_answer.on_code	String within 32 characters	Blank
<p>Description: Configures the no answer forward on code to activate the server-side no answer forward feature. The IP phone will send the no answer forward on code and the pre-configured destination number to the server when you activate no answer forward feature on the IP phone. Example: forward.no_answer.on_code = *76 Note: For Yealink IP phones (except SIP-T19(P) E2), it works only if the value of the parameter “features.fwd_mode” is set to 0 (Phone). Web User Interface: Features->Forward&DND->Forward->No Answer Forward->On Code Phone User Interface: Menu->Features->Call Forward->No Answer Forward->On Code</p>		
forward.no_answer.off_code	String within 32 characters	Blank
<p>Description: Configures the no answer forward off code to deactivate the server-side no answer forward feature. The IP phone will send the no answer forward off code to the server when you deactivate no answer forward feature on the IP phone. Example: forward.no_answer.off_code = *77 Note: For Yealink IP phones (except SIP-T19(P) E2), it works only if the value of the parameter “features.fwd_mode” is set to 0 (Phone).</p>		

Parameters	Permitted Values	Default
<p>Web User Interface: Features->Forward&DND->Forward->No Answer Forward->Off Code</p> <p>Phone User Interface: Menu->Features->Call Forward->No Answer Forward->Off Code</p>		
features.fwd_diversion_enable	0 or 1	1
<p>Description: Enables or disables the IP phone to present the diversion information when an incoming call is forwarded to your IP phone.</p> <p>0-Disabled 1-Enabled</p> <p>Web User Interface: Features->General Information->Diversion/History-Info</p> <p>Phone User Interface: None</p>		
forward.international.enable	0 or 1	1
<p>Description: Enables or disables the IP phone to forward incoming calls to international numbers (the prefix is 00).</p> <p>0-Disabled 1-Enabled</p> <p>Web User Interface: Features->General Information->Fwd International</p> <p>Phone User Interface: Menu->Settings->Advanced Settings (default password: admin)->FWD International</p>		

To specify the authorized numbers when call forward is enabled via web user interface:

1. Click on **Features->General Information**.
2. Select the desired value from the pull-down list of **Forward Emergency**.
3. Enter the desired value in the **Forward Authorized Numbers** field.

Multiple numbers are separated by commas.

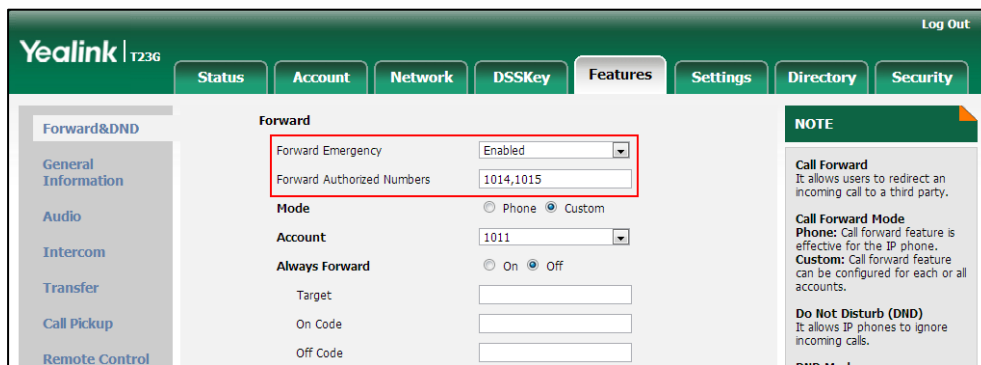

4. Click **Confirm** to accept the change.

To configure call forward via web user interface:

1. Click on **Features->Forward&DND**.
2. In the **Forward** block, mark the desired radio box in the **Mode** field.
 - a) If you mark the **Phone** radio box:
 - 1) Mark the desired radio box in the **Always/Busy/No Answer Forward** field.
 - 2) Enter the destination number you want to forward in the **Target** field.
 - 3) (Optional.) Enter the on code and off code in the **On Code** and **Off Code** fields.
 - 4) Select the ring time to wait before forwarding from the pull-down list of **After Ring Time(0~120s)** (only for the no answer forward).

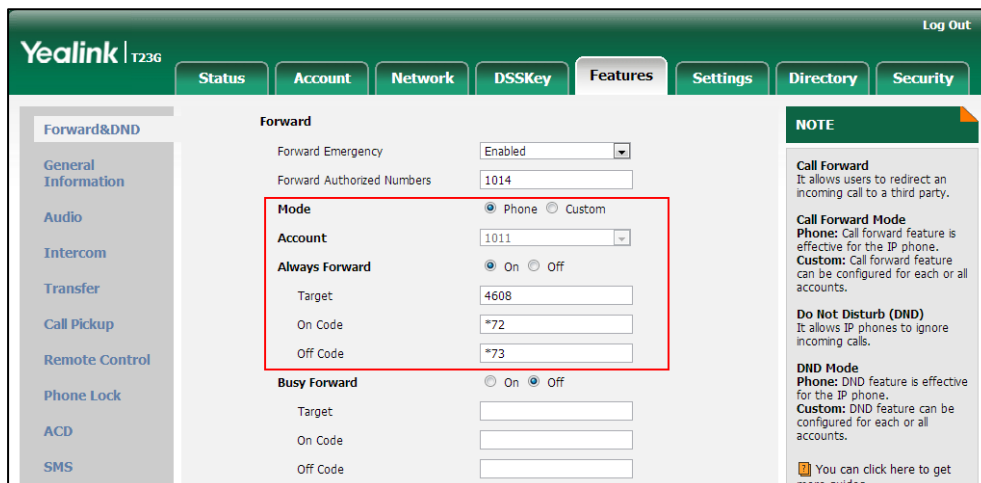

- b) If you mark the **Custom** radio box:
 - 1) Select the desired account from the pull-down list of **Account**.
 - 2) Mark the desired radio box in the **Always/Busy/No Answer Forward** field.
 - 3) Enter the destination number you want to forward in the **Target** field.
 - 4) Enter the on code and off code in the **On Code** and **Off Code** fields.
 - 5) Select the ring time to wait before forwarding from the pull-down list of

After Ring Time(0~120s) (only for the no answer forward).

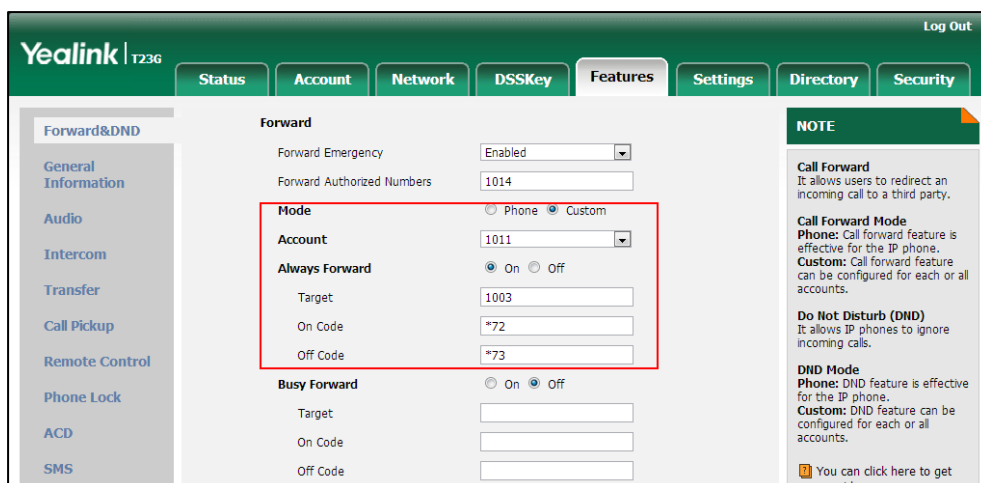

3. Click **Confirm** to accept the change.

To configure Diversion/History-Info feature via web user interface:

1. Click on **Features->General Information**.
2. Select the desired value from the pull-down list of **Diversion/History-Info**.

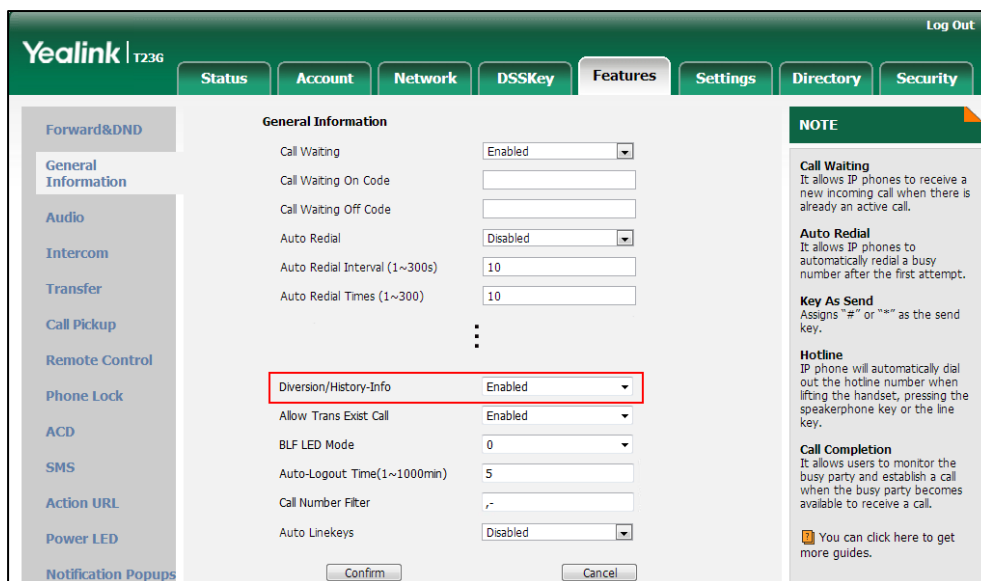

3. Click **Confirm** to accept the change.

To configure forward international via web user interface:

1. Click on **Features->General Information**.



- Select the desired value from the pull-down list of **Fwd International**.

The screenshot shows the Yealink T236 web interface. The 'Features' tab is selected. Under 'General Information', the 'Fwd International' dropdown menu is highlighted with a red box and set to 'Enabled'. Other settings include Call Waiting (Enabled), Call Waiting On Code, Call Waiting Off Code, Auto Redial (Disabled), Auto Redial Interval (1~300s) set to 10, Auto Redial Times (1~300) set to 10, Allow Trans Exist Call (Enabled), BLF LED Mode (0), Auto-Logout Time(1~1000min) set to 5, Call Number Filter, and Auto Linekeys (Disabled). A 'NOTE' section on the right provides details for Call Waiting, Auto Redial, Key As Send, Hotline, and Call Completion. 'Confirm' and 'Cancel' buttons are at the bottom.

- Click **Confirm** to accept the change.

To configure call forward in phone mode via phone user interface:







- Press **Menu->Features->Call Forward**.
- Press \uparrow or \downarrow to select the desired forwarding type, and then press the **Enter** soft key.
- Depending on your selection:
 - If you select **Always Forward**:
 - Press \leftarrow or \rightarrow , or the **Switch** soft key to select the desired value from the **Always Forward** field.
 - Enter the destination number you want to forward all incoming calls to in the **Forward to** field.
 - (Optional.) Enter the always forward on code and off code respectively in the **On Code** and **Off Code** fields.
 - If you select **Busy Forward**:
 - Press \leftarrow or \rightarrow , or the **Switch** soft key to select the desired value from the **Busy Forward** field.
 - Enter the destination number you want to forward all incoming calls to when the IP phone is busy in the **Forward to** field.
 - (Optional.) Enter the busy forward on code and off code respectively in the **On Code** and **Off Code** fields.
 - If you select **No Answer Forward**:
 - Press \leftarrow or \rightarrow , or the **Switch** soft key to select the desired value from the **No Answer Forward** field.
 - Enter the destination number you want to forward all unanswered incoming calls to in the **Forward to** field.

- 3) (Optional.) Enter the no answer forward on code and off code respectively in the **On Code** and **Off Code** fields.
- 4) Press  or , or the **Switch** soft key to select the ring time to wait before forwarding from the **After Ring Time** field.



The default ring time is 12 seconds.

4. Press the **Save** soft key to accept the change.

To configure call forward in custom mode via phone user interface:



1. Press **Menu->Features->Call Forward**.
2. Press  or  to select the desired account, and then press the **Enter** soft key.
3. Press  or  to select the desired forwarding type, and then press the **Enter** soft key.
4. Depending on your selection:
 - a) If you select **Always Forward**, you can configure it for a specific account.
 - 1) Press  or , or the **Switch** soft key to select the desired value from the **Always Forward** field.
 - 2) Enter the destination number you want to forward all incoming calls to in the **Forward to** field.
 - 3) (Optional.) Enter the always forward on code and off code respectively in the **On Code** and **Off Code** fields.

You can also configure the always forward for all accounts. After the always forward was configured for a specific account, do the following:



- 1) Press  or  to highlight the **Always Forward** field.
- 2) Press the **All Lines** soft key.

The LCD screen prompts "Copy to all lines?".
- 3) Press the **OK** soft key to accept the change.





- b) If you select **Busy Forward**, you can configure it for a specific account.

- 1) Press  or , or the **Switch** soft key to select the desired value from the **Busy Forward** field.
- 2) Enter the destination number you want to forward all incoming calls to when the IP phone is busy in the **Forward to** field.
- 3) (Optional.) Enter the busy forward on code and off code respectively in the **On Code** and **Off Code** fields.



You can also configure the busy forward for all accounts. After the busy forward was configured for a specific account, do the following:

- 1) Press  or  to highlight the **Busy Forward** field.
- 2) Press the **All Lines** soft key.



The LCD screen prompts "Copy to all lines?".
- 3) Press the **OK** soft key to accept the change.

- c) If you select **No Answer Forward**, you can configure it for a specific account.
- 1) Press  or , or the **Switch** soft key to select the desired value from the **No Answer Forward** field.
 - 2) Enter the destination number you want to forward all unanswered incoming calls to in the **Forward to** field.
 - 3) Press  or , or the **Switch** soft key to select the ring time to wait before forwarding from the **After Ring Time** field.
 - 4) The default ring time is 12 seconds.
 - 5) (Optional.) Enter the no answer forward on code and off code respectively in the **On Code** and **Off Code** fields.

You can also configure the no answer forward for all accounts. After the no answer forward was configured for a specific account, do the following:

- 1) Press  or  to highlight the **No Answer Forward** field.
 - 2) Press the **All Lines** soft key.
The LCD screen prompts "Copy to all lines?".
 - 3) Press the **OK** soft key to accept the change.
5. Press the **Save** soft key to accept the change.

To configure forward international via phone user interface:

1. Press **Menu->Settings->Advanced Settings** (default password: admin) ->**FWD International**.
2. Press  or , or the **Switch** soft key to select the desired value from the **FWD International** field.
3. Press the **Save** soft key to accept the change.

Call Transfer

Call transfer enables IP phones to transfer an existing call to another party. IP phones support call transfer using the REFER method specified in RFC 3515 and offer three types of transfer:

- **Blind Transfer** -- Transfer a call directly to another party without consulting. Blind transfer is implemented by a simple REFER method without Replaces in the Refer-To header.
- **Semi-attended Transfer** -- Transfer a call after hearing the ringback tone. Semi-attended transfer is implemented by a REFER method with Replaces in the Refer-To header.
- **Attended Transfer** -- Transfer a call with prior consulting. Attended transfer is implemented by a REFER method with Replaces in the Refer-To header.

Normally, call transfer is completed by pressing the transfer key. Blind transfer on hook and attended transfer on hook features allow the IP phone to complete the transfer

through on-hook.

When a user performs a semi-attended transfer, semi-attended transfer feature determines whether to display the prompt "**n New Missed Call(s)**" ("n" indicates the number of the missed calls) on the destination party's phone LCD screen.

Procedure

Call transfer can be configured using the configuration files or locally.

Configuration File	<y0000000000xx>.cfg	Specify whether to complete the transfer through on-hook. Parameters: transfer.blind_tran_on_hook_enable transfer.on_hook_trans_enable Configure semi-attended transfer feature. Parameter: transfer.semi_attend_tran_enable
Local	Web User Interface	Specify whether to complete the transfer through on-hook. Configure semi-attended transfer feature. Navigate to: http://<phoneIPAddress>/servlet?p=features-transfer&q=load

Details of Configuration Parameters:

Parameters	Permitted Values	Default
transfer.blind_tran_on_hook_enable	0 or 1	1
<p>Description: Enables or disables the IP phone to complete the blind transfer through on-hook besides pressing the Tran/Transfer soft key or TRAN/TRANSFER key. (Blind transfer means transfer a call directly to another party without consulting).</p> <p>0-Disabled 1-Enabled</p> <p>Web User Interface: Features->Transfer->Blind Transfer On Hook</p> <p>Phone User Interface:</p>		

Parameters	Permitted Values	Default
None		
transfer.on_hook_trans_enable	0 or 1	1
<p>Description: Enables or disables the IP phone to complete the semi-attended/attended transfer through on-hook besides pressing the Tran/Transfer soft key or TRAN/TRANSFER key. 0-Disabled 1-Enabled</p> <p>Web User Interface: Features->Transfer->Attend Transfer On Hook</p> <p>Phone User Interface: None</p>		
transfer.semi_attend_tran_enable	0 or 1	1
<p>Description: Enables or disables the transfer-to party's phone not to prompt a missed call on the LCD screen before displaying the caller ID when completing a semi-attended transfer. 0-Disabled 1-Enabled</p> <p>Web User Interface: Features->Transfer->Semi-Attend Transfer</p> <p>Phone User Interface: None</p>		

To configure call transfer via web user interface:

1. Click on **Features->Transfer**.

- Select the desired values from the pull-down lists of **Semi-Attend Transfer**, **Blind Transfer on Hook** and **Attend Transfer on Hook**.

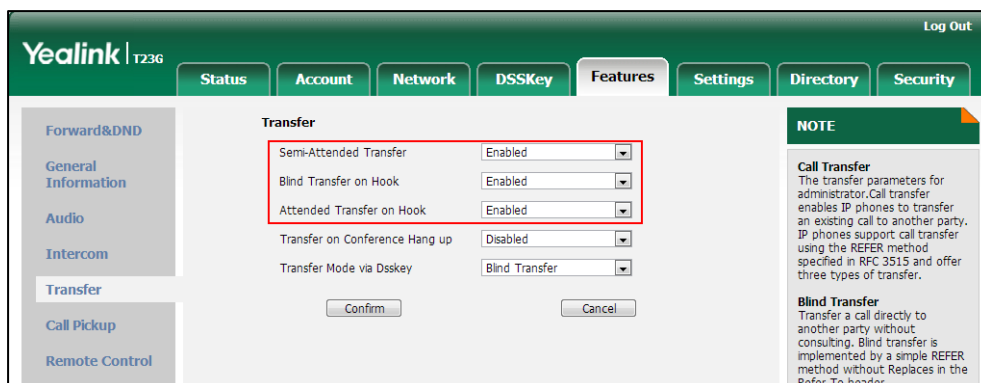

- Click **Confirm** to accept the change.

Network Conference

Network conference, also known as centralized conference, provides users with flexibility of call with multiple participants (more than three). IP phones implement network conference using the REFER method specified in RFC 4579. This feature depends on support from a SIP server.

Procedure

Network conference can be configured using the configuration files or locally.

Configuration File	<MAC>.cfg	Configure network conference. Parameters: account.X.conf_type account.X.conf_uri
Local	Web User Interface	Configure network conference. Navigate to: http://<phoneIPAddress>/servlet ?p=account-adv&q=load&acc=0

Details of Configuration Parameters:

Parameters	Permitted Values	Default
account.X.conf_type	0 or 2	0

Parameters	Permitted Values	Default
<p>Description: Configures the network conference type for account X. 0-Local Conference 2-Network Conference If it is set to 0 (Local Conference), conferences are set up on the IP phone locally. If it is set to 2 (Network Conference), conferences are set up by the server. X ranges from 1 to 16 (for SIP-T48G/T46G/T29G) X ranges from 1 to 12 (for SIP-T42G) X ranges from 1 to 6 (for SIP-T41P/T27P) X ranges from 1 to 3 (for SIP-T23P/G) X ranges from 1 to 2 (for SIP-T21(P) E2) X is equal to 1 (for SIP-T19(P) E2)</p> <p>Web User Interface: Account->Advanced->Conference Type</p> <p>Phone User Interface: None</p>		
account.X.conf_uri	SIP URI within 511 characters	Blank
<p>Description: Configures the network conference URI for account X. X ranges from 1 to 16 (for SIP-T48G/T46G/T29G) X ranges from 1 to 12 (for SIP-T42G) X ranges from 1 to 6 (for SIP-T41P/T27P) X ranges from 1 to 3 (for SIP-T23P/G) X ranges from 1 to 2 (for SIP-T21(P) E2) X is equal to 1 (for SIP-T19(P) E2)</p> <p>Example: account.1.conf_uri = conference@example.com</p> <p>Note: It works only if the value of the parameter "account.X.conf_type" is set to 2 (Network Conference).</p> <p>Web User Interface: Account->Advanced->Conference URI</p> <p>Phone User Interface: None</p>		

To configure the network conference via web user interface:

1. Click on **Account->Advanced**.
2. Select the desired account from the pull-down list of **Account**.
3. Select **Network Conference** from the pull-down list of **Conference Type**.
4. Enter the conference URI in the **Conference URI** field.

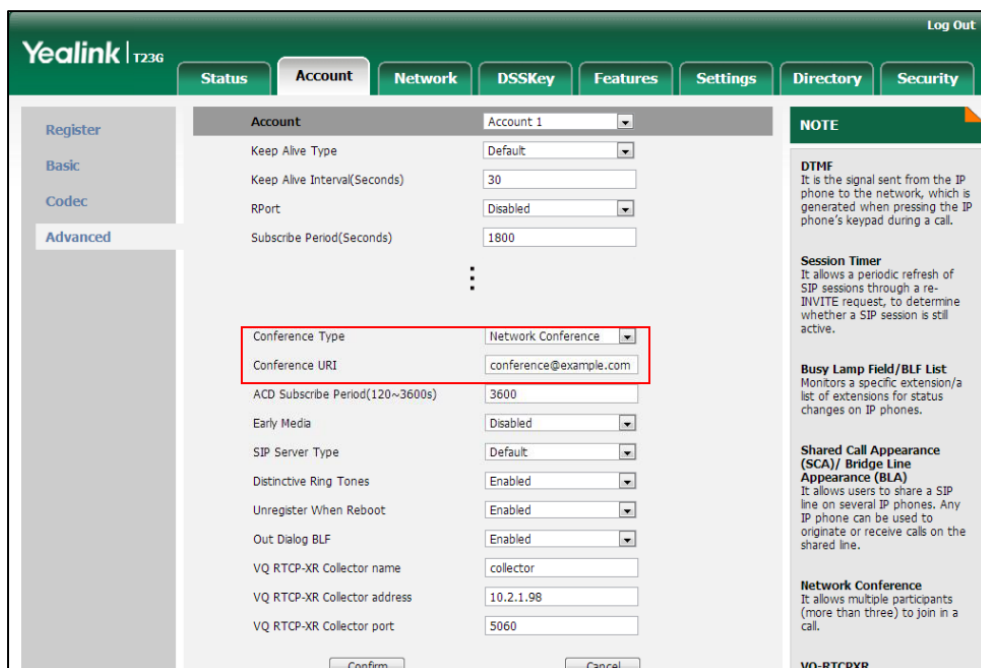

5. Click **Confirm** to accept the change.

Feature Key Synchronization

Feature key synchronization provides the capability to synchronize the status of the following features between the IP phone and the server:

- Do Not Disturb (DND)
- Call Forwarding Always (CFA)
- Call Forwarding Busy (CFB)
- Call Forwarding No Answer (CFNA)

Procedure

Feature key synchronization can be configured using the configuration files or locally.

<p>Configuration File</p>	<p><y0000000000xx>.cfg</p>	<p>Configure feature key synchronization. Parameter: bw.feature_key_sync</p>
----------------------------------	----------------------------------	---

Local	Web User Interface	<p>Configure feature key synchronization.</p> <p>Navigate to:</p> <p>http://<phoneIPAddress>/servlet?p=features-general&q=load</p>
-------	--------------------	---

Details of Configuration Parameter:

Parameters	Permitted Values	Default
bw.feature_key_sync	0 or 1	0
<p>Description:</p> <p>Enables or disables feature key synchronization.</p> <p>0-Disabled</p> <p>1-Enabled</p> <p>Web User Interface:</p> <p>Features->General Information->Feature Key Synchronization</p> <p>Phone User Interface:</p> <p>None</p>		

To configure feature key synchronization via web user interface:

1. Click on **Features->General Information**.
2. Select **Enabled** from the pull-down list of **Feature Key Synchronization**.

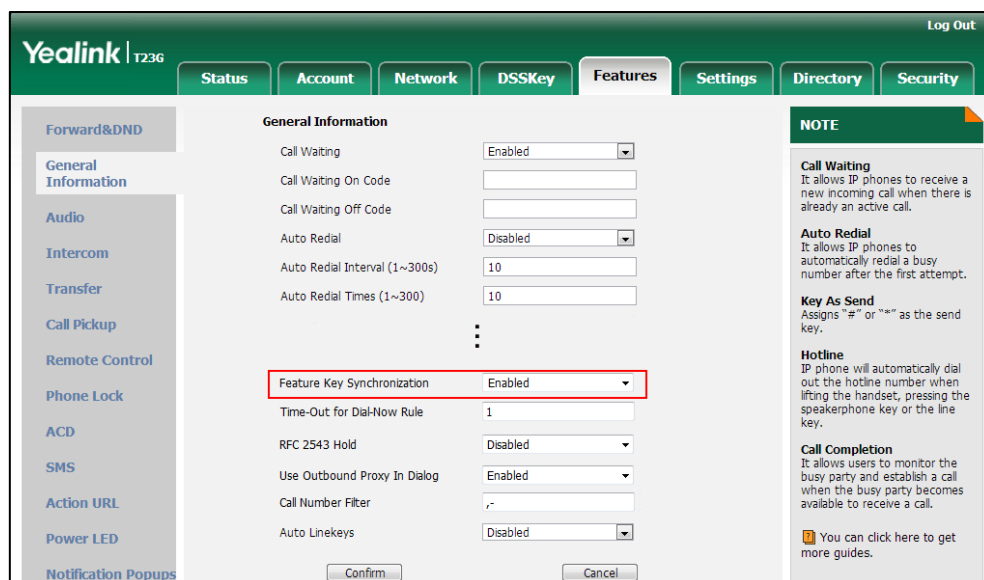

3. Click **Confirm** to accept the change.

Transfer on Conference Hang Up

For a conference call, all parties drop the call when the conference initiator drops the conference call. For local conference, transfer on conference hang up allows the other two parties to remain connected when the conference initiator drops the conference call.

Procedure

Transfer on conference hang up can be configured using the configuration files or locally.

Configuration File	<y0000000000xx>.cfg	Configure the transfer on conference hang up. Parameter: transfer.tran_others_after_conf_enable
Local	Web User Interface	Configure the transfer on conference hang up. Navigate to: http://<phoneIPAddress>/servlet?p=features-transfer&q=load

Details of the Configuration Parameter:

Parameter & Description	Permitted Values	Default
transfer.tran_others_after_conf_enable	0 or 1	0
<p>Description: Enables or disables the IP phone to transfer the local conference call to the other two parties after the conference initiator drops the local conference call.</p> <p>0-Disabled 1-Enabled</p> <p>If it is set to 1 (Enabled), the other two parties remain connected when the conference initiator drops the conference call.</p> <p>Note: It works only if the value of parameters "account.X.conf_type" is set to 0 (Local Conference).</p> <p>Web User Interface: Features->Transfer->Transfer on Conference Hang up</p> <p>Phone User Interface: None</p>		

To configure transfer on conference hang up via web user interface:

1. Click on **Features->Transfer**.
2. Select the desired value from the pull-down list of **Transfer on Conference Hang up**.

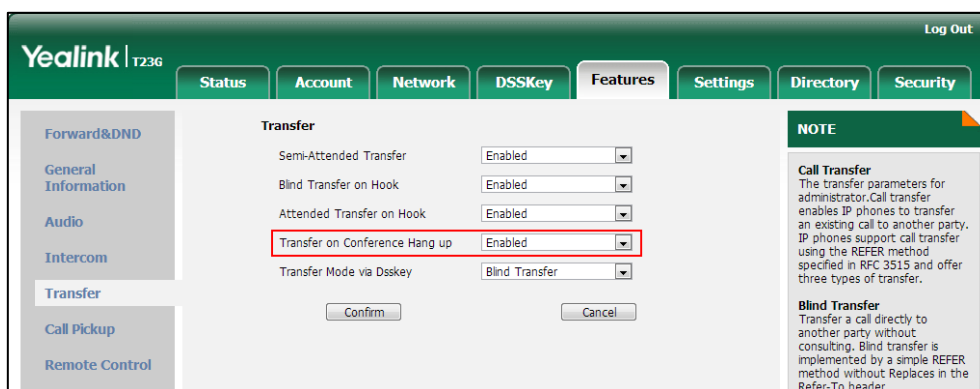

3. Click **Confirm** to accept the change.

Transfer Mode via Dsskey

Transfer mode via dsskey enables IP phones to handle the current call differently via the DSS key. IP phones support three transfer modes: New Call, Blind Transfer and Attended Transfer. For more information on Blind Transfer and Attended Transfer, refer to [Call Transfer](#) on page 305.

Note This feature is not applicable to SIP-T19(P) E2 IP phones.

The transfer mode via dsskey feature is available when the DSS key is assigned to the following features:

- Speed dial
- Transfer
- BLF/BLF List

For more information on how to configure the DSS Key, refer to [Appendix D: Configuring DSS Key](#) on page 751.

Procedure

Transfer mode via dsskey can be configured using the configuration files or locally.

<p>Configuration File</p>	<p><y0000000000xx>.cfg</p>	<p>Configure the transfer mode via dsskey. Parameter: transfer.dsskey_deal_type</p>
----------------------------------	----------------------------------	--

Local	Web User Interface	Configure the transfer mode via dsskey. Navigate to: http://<phoneIPAddress>/servlet ?p=features-transfer&q=load
-------	--------------------	--

Details of the Configuration Parameter:

Parameters	Permitted Values	Default
transfer.dsskey_deal_type	0, 1 or 2	2
<p>Description: Configures the transfer mode when user presses the DSS key during an active call. To use this feature, you need to configure the DSS key as a speed dial, transfer or BLF/BLF List in advance.</p> <p>0-New Call 1-Attended Transfer 2-Blind Transfer</p> <p>Note: It is not applicable to SIP-T19(P) E2 IP phones.</p> <p>Web User Interface: Features->Transfer->Transfer Mode via Dsskey</p> <p>Phone User Interface: None</p>		

To configure transfer mode via dsskey via web user interface:

1. Click on **Features->Transfer**.
2. Select the desired value from the pull-down list of **Transfer Mode via Dsskey**.

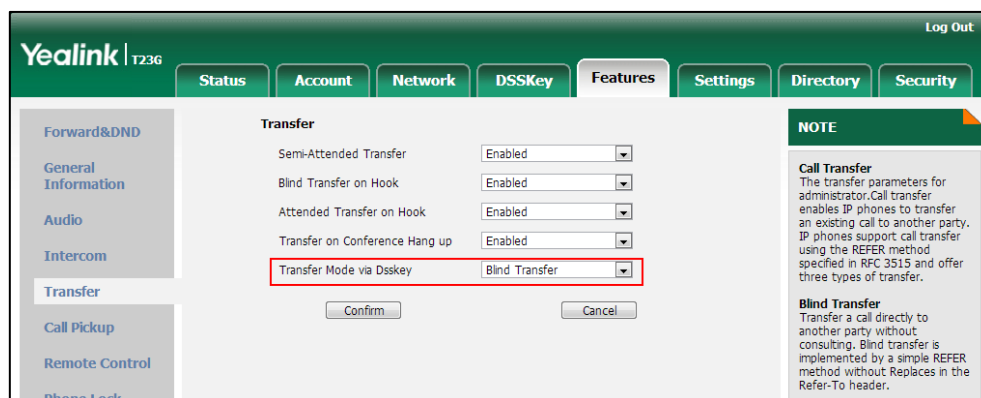

3. Click **Confirm** to accept the change.

Allow Trans Exist Call

Allow trans exist call feature allows users to select transfer-to party's call during multiple calls. It is convenient to transfer the active call to another existing call.

Procedure

Allow trans exist call can be configured using the configuration files or locally.

Configuration File	<y0000000000xx>.cfg	Configure allow trans exist call. Parameters: transfer.multi_call_trans_enable
Local	Web User Interface	Configure allow trans exist call. Navigate to: http://<phoneIPAddress>/servlet?p=features-general&q=load

Details of Configuration Parameters:

Parameters	Permitted Values	Default
transfer.multi_call_trans_enable	0 or 1	1
<p>Description:</p> <p>Enables or disables the IP phone to select transfer-to party's call (a new call or another existing call) during multiple calls when user presses the Tran/Transfer soft key or TRAN/TRANSFER key.</p> <p>0-Disabled 1-Enabled</p> <p>If it is set to 1 (Enabled), the user can select to transfer the active call to a new call or another existing call during multiple calls when the user presses the Tran/Transfer soft key or TRAN/TRANSFER key.</p> <p>If it is set to 0 (Disabled), the user can transfer the active call to a new call during multiple calls when the user presses the Tran/Transfer soft key or TRAN/TRANSFER key.</p> <p>Note: It is not applicable to SIP-T48G/T46G/T29G IP phones.</p> <p>Web User Interface: Features->General Information->Allow Trans Exist Call</p> <p>Phone User Interface: None</p>		

To configure allow trans exist call via web user interface:

1. Click on **Feature->General Information**.
2. Select the desired value from the pull-down list of **Allow Trans Exist Call**.

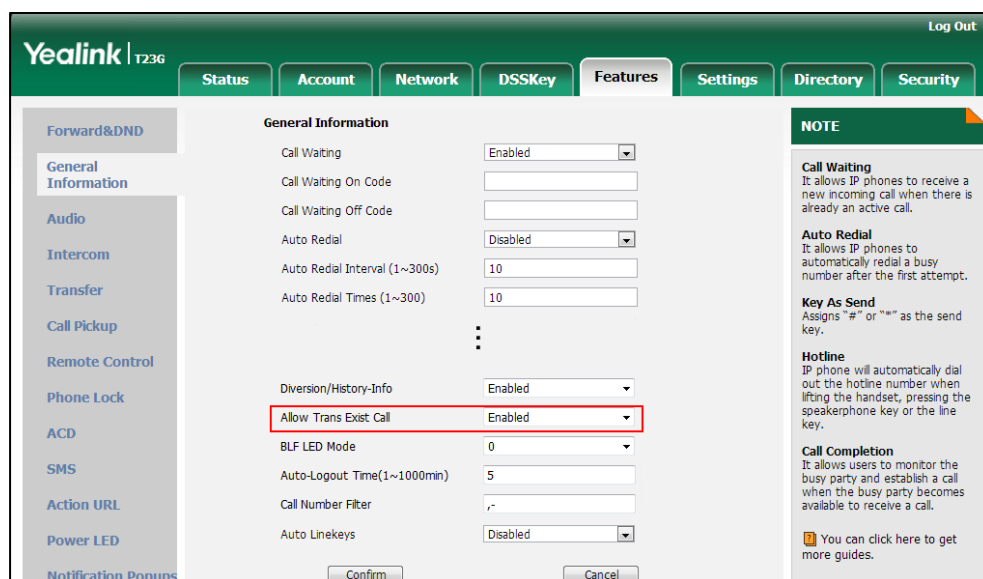

3. Click **Confirm** to accept the change.

Directed Call Pickup

Directed call pickup is used for picking up an incoming call on a specific extension. A user can pick up the incoming call using a directed pickup key or the DPickup soft key. This feature depends on support from a SIP server. For many SIP servers, directed call pickup requires a directed pickup code, which can be configured on a phone or a per-line basis.

Note It is recommended not to configure the directed call pickup key and the DPickup soft key simultaneously. If you do, the directed call pickup key will not be used correctly.

Procedure

Directed call pickup can be configured using the configuration files or locally.

<p>Configuration File</p>	<p><MAC>.cfg</p>	<p>Configure the directed call pickup code on a per-line basis.</p> <p>Parameter:</p> <p>account.X.direct_pickup_code</p> <p>Configure directed call pickup features on a phone basis.</p> <p>Parameters:</p>
----------------------------------	------------------------	---

		<p>features.pickup.direct_pickup_enable</p> <p>features.pickup.direct_pickup_code</p>
	<p><y0000000000xx>.cfg</p>	<p>Assign a directed call pickup key.</p> <p>Parameters:</p> <p>linekey.X.type/ programablekey.X.type/ expansion_module.X.key.Y.type</p> <p>linekey.X.line/ programablekey.X.line/ expansion_module.X.key.Y.line</p> <p>linekey.X.value/ programablekey.X.value/ expansion_module.X.key.Y.value</p> <p>linekey.X.label/ programablekey.X.label/ expansion_module.X.key.Y.label</p>
<p>Local</p>	<p>Web User Interface</p>	<p>Assign a directed call pickup key.</p> <p>Navigate to:</p> <p>http://<phoneIPAddress>/servlet?p=dsskey&q=load&model=0</p> <p>Configure directed call pickup code on a per-line basis.</p> <p>Navigate to:</p> <p>http://<phoneIPAddress>/servlet?p=account-adv&q=load&acc=0</p> <p>Configure directed call pickup feature on a phone basis.</p> <p>Navigate to:</p> <p>http://<phoneIPAddress>/servlet?p=features-callpickup&q=load</p>
	<p>Phone User Interface</p>	<p>Assign a directed call pickup key.</p>

Details of Configuration Parameters:

Parameters	Permitted Values	Default
account.X.direct_pickup_code	String within 32 characters	Blank
<p>Description: Configures the directed call pickup code for account X. X ranges from 1 to 16 (for SIP-T48G/T46G/T29G) X ranges from 1 to 12 (for SIP-T42G) X ranges from 1 to 6 (for SIP-T41P/T27P) X ranges from 1 to 3 (for SIP-T23P/G) X ranges from 1 to 2 (for SIP-T21(P) E2) X is equal to 1 (for SIP-T19(P) E2)</p> <p>Example: account.1.direct_pickup_code = *68</p> <p>Note: The directed call pickup code configured on a per-line basis takes precedence over that configured on a phone basis.</p> <p>Web User Interface: Account->Advanced->Directed Call Pickup Code</p> <p>Phone User Interface: None</p>		
features.pickup.direct_pickup_enable	0 or 1	0
<p>Description: Enables or disables the IP phone to display the DPickup soft key when the IP phone is on the pre-dialing screen.</p> <p>0-Disabled 1-Enabled</p> <p>Web User Interface: Features->Call Pickup->Directed Call Pickup</p> <p>Phone User Interface: None</p>		
features.pickup.direct_pickup_code	String within 32 characters	Blank
<p>Description: Configures the directed call pickup code on a phone basis.</p>		

Parameters	Permitted Values	Default
<p>Example:</p> <pre>features.pickup.direct_pickup_code = *97</pre> <p>Note: The directed call pickup code configured on a per-line basis takes precedence over that configured on a phone basis.</p> <p>Web User Interface:</p> <p>Features->Call Pickup->Directed Call Pickup Code</p> <p>Phone User Interface:</p> <p>None</p>		

Directed Call Pickup Key

For more information on how to configure the DSS Key, refer to [Appendix D: Configuring DSS Key](#) on page 751.

Parameters	Permitted Values	Default
linekey.X.type/ programablekey.X.type/ expansion_module.X.key.Y.type	9	Refer to the following content
<p>Description:</p> <p>Configures a DSS key as a directed call pickup key on the IP phone.</p> <p>The digit 9 stands for the key type Direct Pickup.</p> <p>For line keys:</p> <ul style="list-style-type: none"> X ranges from 1 to 29 (for SIP-T48G) X ranges from 1 to 27 (for SIP-T46G/T29G) X ranges from 1 to 15 (for SIP-T42G/T41P) X ranges from 1 to 21 (for SIP-T27P) X ranges from 1 to 3 (for SIP-T23P/G) X ranges from 1 to 2 (for SIP-T21(P) E2) <p>For programable keys:</p> <ul style="list-style-type: none"> X=1-10, 12-14 (for SIP-T48G/T46G) X=1-10, 13 (for SIP-T42G/T41P) X=1-14 (for SIP-T29G/T27P) X=1-10, 14 (for SIP-T23P/T23G/T21(P) E2) X=1-9, 13, 14 (for SIP-T19(P) E2) <p>For ext keys:</p>		

Parameters	Permitted Values	Default
<p>X ranges from 1 to 6, Y ranges from 1 to 20, 22 to 40 (Ext key 21 cannot be configured).</p> <p>Example:</p> <p>linekey.1.type = 9</p> <p>Default:</p> <p>For line keys:</p> <p>For SIP-T48G IP phones:</p> <p>The default value of the line key 1-16 is 15, and the default value of the line key 17-29 is 0.</p> <p>For SIP-T46G/T29G IP phones:</p> <p>The default value of the line key 1-16 is 15, and the default value of the line key 17-27 is 0.</p> <p>For SIP-T42G IP phones:</p> <p>The default value of the line key 1-12 is 15, and the default value of the line key 13-15 is 0.</p> <p>For SIP-T41P IP phones:</p> <p>The default value of the line key 1-6 is 15, and the default value of the line key 7-15 is 0.</p> <p>For SIP-T27P IP phones:</p> <p>The default value of the line key 1-6 is 15, and the default value of the line key 7-21 is 0.</p> <p>For SIP-T23P/T23G/T21(P) E2 IP phones:</p> <p>The default value is 15.</p> <p>For programable keys:</p> <p>For SIP-T48G/T46G IP phones:</p> <p>When X=1, the default value is 28 (History).</p> <p>When X=2, the default value is 61 (Directory).</p> <p>When X=3, the default value is 5 (DND).</p> <p>When X=4, the default value is 30 (Menu).</p> <p>When X=5, the default value is 28 (History).</p> <p>When X=6, the default value is 61 (Directory).</p> <p>When X=7, the default value is 0 (NA).</p> <p>When X=8, the default value is 0 (NA).</p> <p>When X=9, the default value is 33 (Status).</p> <p>When X=10, the default value is 0 (NA).</p> <p>When X=12, the default value is 0 (NA).</p>		

Parameters	Permitted Values	Default
<p>When X=13, the default value is 0 (NA).</p> <p>When X=14, the default value is 2 (Forward).</p> <p>For SIP-T42G/T41P IP phones:</p> <p>When X=1, the default value is 28 (History).</p> <p>When X=2, the default value is 61 (Directory).</p> <p>When X=3, the default value is 5 (DND).</p> <p>When X=4, the default value is 30 (Menu).</p> <p>When X=5, the default value is 28 (History).</p> <p>When X=6, the default value is 61 (Directory).</p> <p>When X=7, the default value is 0 (NA).</p> <p>When X=8, the default value is 0 (NA).</p> <p>When X=9, the default value is 33 (Status).</p> <p>When X=10, the default value is 0 (NA).</p> <p>When X=13, the default value is 0 (NA).</p> <p>For SIP-T29G/T27P IP phones:</p> <p>When X=1, the default value is 28 (History).</p> <p>When X=2, the default value is 61 (Directory).</p> <p>When X=3, the default value is 5 (DND).</p> <p>When X=4, the default value is 30 (Menu).</p> <p>When X=5, the default value is 28 (History).</p> <p>When X=6, the default value is 61 (Directory).</p> <p>When X=7, the default value is 0 (NA).</p> <p>When X=8, the default value is 0 (NA).</p> <p>When X=9, the default value is 33 (Status).</p> <p>When X=10, the default value is 0 (NA).</p> <p>When X=11, the default value is 0 (NA).</p> <p>When X=12, the default value is 0 (NA).</p> <p>When X=13, the default value is 0 (NA).</p> <p>When X=14, the default value is 2 (Forward).</p> <p>For SIP-T23P/T23G/T21(P) E2 IP phones:</p> <p>When X=1, the default value is 28 (History).</p> <p>When X=2, the default value is 61 (Directory).</p> <p>When X=3, the default value is 5 (DND).</p> <p>When X=4, the default value is 30 (Menu).</p> <p>When X=5, the default value is 28 (History).</p>		

Parameters	Permitted Values	Default
<p>When X=6, the default value is 61 (Directory). When X=7, the default value is 0 (NA). When X=8, the default value is 0 (NA). When X=9, the default value is 33 (Status). When X=10, the default value is 0 (NA). When X=14, the default value is 2 (Forward).</p> <p>For SIP-T19(P) E2 IP phones:</p> <p>When X=1, the default value is 28 (History). When X=2, the default value is 61 (Directory). When X=3, the default value is 5 (DND). When X=4, the default value is 30 (Menu). When X=5, the default value is 28 (History). When X=6, the default value is 61 (Directory). When X=7, the default value is 0 (NA). When X=8, the default value is 0 (NA). When X=9, the default value is 33 (Status). When X=13, the default value is 0 (NA). When X=14, the default value is 2 (Forward).</p> <p>For ext keys: When Y=1, the default value is 37 (Switch). When Y= 2 to 20, 22 to 40, the default value is 0 (NA).</p> <p>Web User Interface: DSSKey->Line Key/Programable Key->Type</p> <p>Phone User Interface: Menu->Features->DSS Keys->Line Key X->Type</p>		
<p>linekey.X.line/ programablekey.X.line/ expansion_module.X.key.Y.line</p>	<p>Refer to the following content</p>	<p>1-16 for lines 1-16, 1 for programable key</p>
<p>Description:</p> <p>Configures the desired line to apply the directed call pickup key.</p> <p>For line keys: X ranges from 1 to 29 (for SIP-T48G). X ranges from 1 to 27 (for SIP-T46G/T29G). X ranges from 1 to 15 (for SIP-T42G/T41P). X ranges from 1 to 21 (for SIP-T27P).</p>		

Parameters	Permitted Values	Default
<p>X ranges from 1 to 3 (for SIP-T23P/G) X ranges from 1 to 2 (for SIP-T21(P) E2) For programable keys: X=1-10, 12-14 (for SIP-T48G/T46G) X=1-10, 13 (for SIP-T42G/T41P) X=1-14 (for SIP-T29G/T27P) X=1-10, 14 (for SIP-T23P/T23G/T21(P) E2) For ext keys: X ranges from 1 to 6, Y ranges from 1 to 20, 22 to 40 (Ext key 21 cannot be configured).</p> <p>Permitted Values: 1 to 16 (for SIP-T48G/T46G/T29G) 1 to 12 (for SIP-T42G) 1 to 6 (for SIP-T41P/T27P) 1 to 3 (for SIP-T23P/G) 1 to 2 (for SIP-T21(P) E2) 1-Line 1 2-Line 2 ... 16-Line 16</p> <p>Note: It is not applicable to SIP-T19(P) E2 IP phones.</p> <p>Example: linekey.1.line = 1</p> <p>Web User Interface: DSSKey->Line Key/Programable Key->Line</p> <p>Phone User Interface: Menu->Features->DSS Keys->Line Key X->Account ID</p>		
<p>linekey.X.value/ programablekey.X.value/ expansion_module.X.key.Y.value</p>	<p>String within 99 characters</p>	<p>Blank</p>
<p>Description: Configures the directed call pickup feature code followed by the monitored extension. For line keys: X ranges from 1 to 29 (for SIP-T48G). X ranges from 1 to 27 (for SIP-T46G/T29G).</p>		

Parameters	Permitted Values	Default
<p>X ranges from 1 to 15 (for SIP-T42G/T41P). X ranges from 1 to 21 (for SIP-T27P). X ranges from 1 to 3 (for SIP-T23P/G) X ranges from 1 to 2 (for SIP-T21(P) E2) For programable keys: X=1-10, 12-14 (for SIP-T48G/T46G) X=1-10, 13 (for SIP-T42G/T41P) X=1-14 (for SIP-T29G/T27P) X=1-10, 14 (for SIP-T23P/T23G/T21(P) E2) X=1-9, 13, 14 (for SIP-T19(P) E2) For ext keys: X ranges from 1 to 6, Y ranges from 1 to 20, 22 to 40 (Ext key 21 cannot be configured). Example: linekey.1.value = 1008 Web User Interface: DSSKey->Line Key/ Programable Key->Value Phone User Interface: Menu->Features->DSS Keys->Line Key X->Value</p>		
<p>linekey.X.label/ programablekey.X.label/ expansion_module.X.key.Y.label</p>	<p>String within 99 characters</p>	<p>Blank</p>
<p>Description: (Optional.) Configures the label displayed on the LCD screen for each DSS key. For line keys: X ranges from 1 to 29 (for SIP-T48G) X ranges from 1 to 27 (for SIP-T46G/T29G) X ranges from 1 to 15 (for SIP-T42G/T41P) X ranges from 1 to 21 (for SIP-T27P) X ranges from 1 to 3 (for SIP-T23P/G) X ranges from 1 to 2 (for SIP-T21(P) E2) For programable keys: X ranges from 1 to 4. For ext keys: X ranges from 1 to 6, Y ranges from 1 to 20, 22 to 40 (Ext key 21 cannot be</p>		

Parameters	Permitted Values	Default
configured). Web User Interface: DSSKey->Line Key/Programable Key->Label Phone User Interface: Menu->Features->DSS Keys->Line Key X->Label		

To configure a directed call pickup key via web user interface:

1. Click on **DSSKey->Line Key** (or **Programable Key**).
2. In the desired DSS key field, select **Direct Pickup** from the pull-down list of **Type**.
3. Enter the directed call pickup code followed by the specific extension in the **Value** field.
4. (Optional.) Enter the string that will appear on the LCD screen in the **Label** field.
5. Select the desired line from the pull-down list of **Line**.

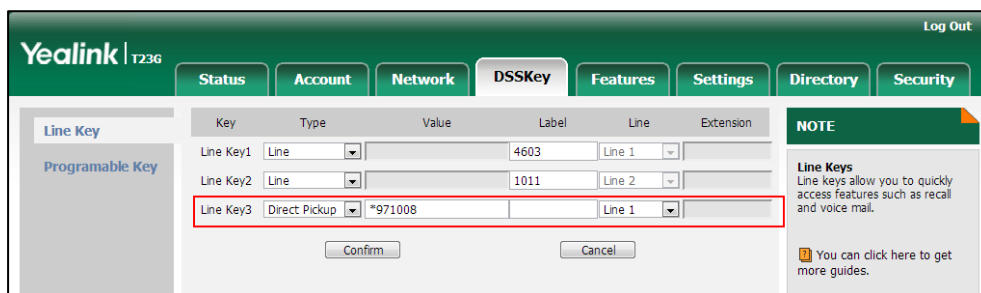

6. Click **Confirm** to accept the change.

To configure the directed call pickup code on a per-line basis via web user interface:

1. Click on **Account->Advanced**.
2. Select the desired account from the pull-down list of **Account**.

3. Enter the directed call pickup code in the **Directed Call Pickup Code** field.

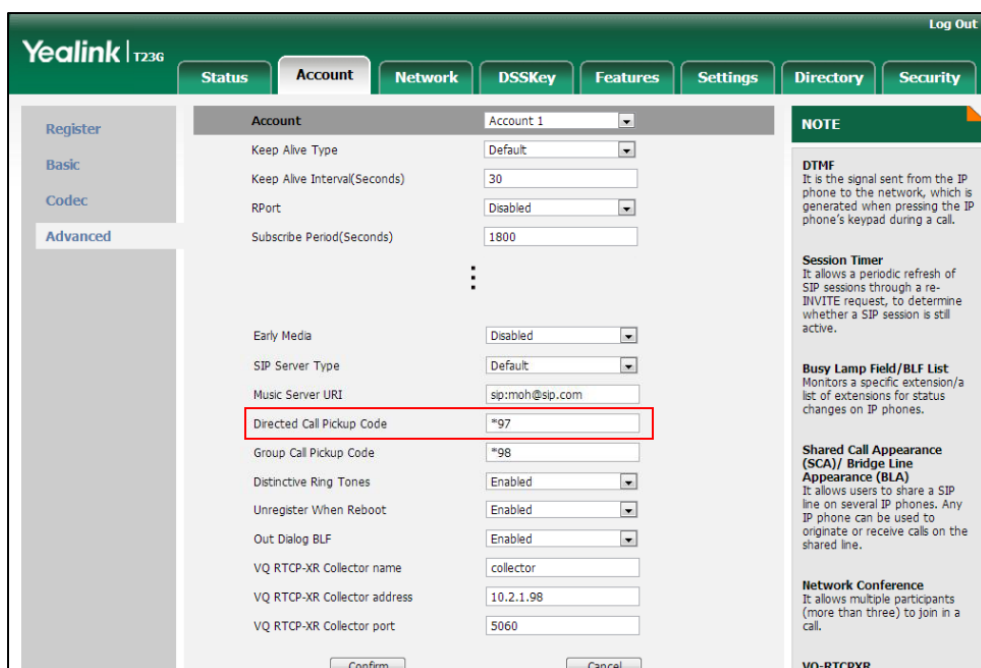

4. Click **Confirm** to accept the change.

To configure directed call pickup feature on a phone basis via web user interface:

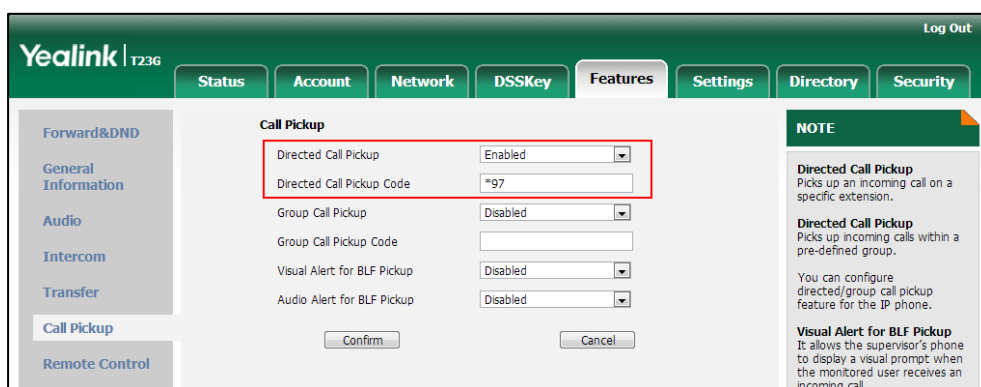

1. Click on **Features->Call Pickup**.
2. Select the desired value from the pull-down list of **Directed Call Pickup**.
3. Enter the directed call pickup code in the **Directed Call Pickup Code** field.



4. Click **Confirm** to accept the change.

To configure a directed pickup key via phone user interface:

1. Press **Menu->Features->DSS Keys**.
2. Select the desired DSS key.
3. Press **←** or **→**, or the **Switch** soft key to select **Key Event** from the **Type** field.
4. Press **←** or **→**, or the **Switch** soft key to select **DPickup** from the **Key Type** field.

5. Press  or  , or the **Switch** soft key to select the desired line from the **Account ID** field.
6. (Optional.) Enter the string that will appear on the LCD screen in the **Label** field.
7. Enter the directed call pickup code followed by the specific extension in the **Value** field.
8. Press the **Save** soft key to accept the change.

Group Call Pickup

Group call pickup is used for picking up incoming calls within a pre-defined group. If the group receives many incoming calls at once, the user will pick up the first incoming call, using a group pickup key or the GPickup soft key. This feature depends on support from a SIP server. For many SIP servers, group call pickup requires a group pickup code, which can be configured on a phone or a per-line basis.

Procedure

Group call pickup can be configured using the configuration files or locally.

Configuration File	<MAC>.cfg	<p>Configure the group call pickup code on a per-line basis.</p> <p>Parameters:</p> <p>account.X.group_pickup_code</p> <p>Configure group call pickup features on a phone basis.</p> <p>Parameters:</p> <p>features.pickup.group_pickup_enable</p> <p>features.pickup.group_pickup_code</p>
	<y000000000xx>.cf g	<p>Assign a group call pickup key.</p> <p>Parameters:</p> <p>linekey.X.type/ programablekey.X.type/ expansion_module.X.key.Y.type</p> <p>linekey.X.line/ programablekey.X.line/ expansion_module.X.key.Y.line</p> <p>linekey.X.value/ programablekey.X.value/ expansion_module.X.key.Y.value</p> <p>linekey.X.label/ programablekey.X.label/ expansion_module.X.key.Y.label</p>

Local	Web User Interface	<p>Assign a group call pickup key.</p> <p>Navigate to: <a href="http://<phoneIPAddress>/servlet?p=dsskey&q=load&model=0">http://<phoneIPAddress>/servlet?p=dsskey&q=load&model=0</p> <p>Configure the group call pickup code on a per-line basis.</p> <p>Navigate to: <a href="http://<phoneIPAddress>/servlet?p=account-adv&q=load&acc=0">http://<phoneIPAddress>/servlet?p=account-adv&q=load&acc=0</p> <p>Configure group call pickup feature on a phone basis.</p> <p>Navigate to: <a href="http://<phoneIPAddress>/servlet?p=features-callpickup&q=load">http://<phoneIPAddress>/servlet?p=features-callpickup&q=load</p>
	Phone User Interface	Assign a group call pickup key.

Details of Configuration Parameters:

Parameters	Permitted Values	Default
features.pickup.group_pickup_enable	0 or 1	0
<p>Description: Enables or disables the IP phone to display the GPickup soft key when the IP phone is on the pre-dialing screen.</p> <p>0-Disabled 1-Enabled</p> <p>Web User Interface: Features->Call Pickup->Group Call Pickup</p> <p>Phone User Interface: None</p>		
account.X.group_pickup_code	String within 32 characters	Blank
<p>Description: Configures the group pickup code for account X. X ranges from 1 to 16 (for SIP-T48G/T46G/T29G) X ranges from 1 to 12 (for SIP-T42G) X ranges from 1 to 6 (for SIP-T41P/T27P)</p>		

Parameters	Permitted Values	Default
<p>X ranges from 1 to 3 (for SIP-T23P/G) X ranges from 1 to 2 (for SIP-T21(P) E2) X is equal to 1 (for SIP-T19(P) E2)</p> <p>Example: account.1.group_pickup_code = *69</p> <p>Note: The group call pickup code configured on a per-line basis takes precedence over that configured on a phone basis.</p> <p>Web User Interface: Account->Advanced->Group Call Pickup Code</p> <p>Phone User Interface: None</p>		
<code>features.pickup.group_pickup_code</code>	String within 32 characters	Blank
<p>Description: Configures the group call pickup code on a phone basis.</p> <p>Example: features.pickup.group_pickup_code = *98</p> <p>Note: The group call pickup code configured on a per-line basis takes precedence over that configured on a phone basis.</p> <p>Web User Interface: Features->Call Pickup->Group Call Pickup Code</p> <p>Phone User Interface: None</p>		

Group Call Pickup Key

For more information on how to configure the DSS Key, refer to [Appendix D: Configuring DSS Key](#) on page 751.

Parameters	Permitted Values	Default
<code>linekey.X.type/ programablekey.X.type/ expansion_module.X.key.Y.type</code>	23	Refer to the following content
<p>Description: Configures a DSS key as a group call pickup key on the IP phone. The digit 23 stands for the key type Group Pickup.</p>		

Parameters	Permitted Values	Default
<p>For line keys:</p> <p>X ranges from 1 to 29 (for SIP-T48G)</p> <p>X ranges from 1 to 27 (for SIP-T46G/T29G)</p> <p>X ranges from 1 to 15 (for SIP-T42G/T41P)</p> <p>X ranges from 1 to 21 (for SIP-T27P)</p> <p>X ranges from 1 to 3 (for SIP-T23P/G)</p> <p>X ranges from 1 to 2 (for SIP-T21(P) E2)</p> <p>For programable keys:</p> <p>X=1-10, 12-14 (for SIP-T48G/T46G)</p> <p>X=1-10, 13 (for SIP-T42G/T41P)</p> <p>X=1-14 (for SIP-T29G/T27P)</p> <p>X=1-10, 14 (for SIP-T23P/T23G/T21(P) E2)</p> <p>X=1-9, 13, 14 (for SIP-T19(P) E2)</p> <p>For ext keys:</p> <p>X ranges from 1 to 6, Y ranges from 1 to 20, 22 to 40 (Ext key 21 cannot be configured).</p> <p>Example:</p> <p>linekey.2.type = 23</p> <p>Default:</p> <p>For SIP-T48G IP phones:</p> <p>The default value of the line key 1-16 is 15, and the default value of the line key 17-29 is 0.</p> <p>For SIP-T46G/T29G IP phones:</p> <p>The default value of the line key 1-16 is 15, and the default value of the line key 17-27 is 0.</p> <p>For SIP-T42G IP phones:</p> <p>The default value of the line key 1-12 is 15, and the default value of the line key 13-15 is 0.</p> <p>For SIP-T41P IP phones:</p> <p>The default value of the line key 1-6 is 15, and the default value of the line key 7-15 is 0.</p> <p>For SIP-T27P IP phones:</p> <p>The default value of the line key 1-6 is 15, and the default value of the line key 7-21 is 0.</p> <p>For SIP-T23P/T23G/T21(P) E2 IP phones:</p> <p>The default value is 15.</p>		

Parameters	Permitted Values	Default
<p>For programable keys:</p> <p>For SIPT48G/T46G IP phones:</p> <p>When X=1, the default value is 28 (History).</p> <p>When X=2, the default value is 61 (Directory).</p> <p>When X=3, the default value is 5 (DND).</p> <p>When X=4, the default value is 30 (Menu).</p> <p>When X=5, the default value is 28 (History).</p> <p>When X=6, the default value is 61 (Directory).</p> <p>When X=7, the default value is 0 (NA).</p> <p>When X=8, the default value is 0 (NA).</p> <p>When X=9, the default value is 33 (Status).</p> <p>When X=10, the default value is 0 (NA).</p> <p>When X=12, the default value is 0 (NA).</p> <p>When X=13, the default value is 0 (NA).</p> <p>When X=14, the default value is 2 (Forward).</p> <p>For SIPT42G/T41P IP phones:</p> <p>When X=1, the default value is 28 (History).</p> <p>When X=2, the default value is 61 (Directory).</p> <p>When X=3, the default value is 5 (DND).</p> <p>When X=4, the default value is 30 (Menu).</p> <p>When X=5, the default value is 28 (History).</p> <p>When X=6, the default value is 61 (Directory).</p> <p>When X=7, the default value is 0 (NA).</p> <p>When X=8, the default value is 0 (NA).</p> <p>When X=9, the default value is 33 (Status).</p> <p>When X=10, the default value is 0 (NA).</p> <p>When X=13, the default value is 0 (NA).</p> <p>For SIPT29G/T27P IP phones:</p> <p>When X=1, the default value is 28 (History).</p> <p>When X=2, the default value is 61 (Directory).</p> <p>When X=3, the default value is 5 (DND).</p> <p>When X=4, the default value is 30 (Menu).</p> <p>When X=5, the default value is 28 (History).</p> <p>When X=6, the default value is 61 (Directory).</p> <p>When X=7, the default value is 0 (NA).</p>		

Parameters	Permitted Values	Default
<p>When X=8, the default value is 0 (NA).</p> <p>When X=9, the default value is 33 (Status).</p> <p>When X=10, the default value is 0 (NA).</p> <p>When X=11, the default value is 0 (NA).</p> <p>When X=12, the default value is 0 (NA).</p> <p>When X=13, the default value is 0 (NA).</p> <p>When X=14, the default value is 2 (Forward).</p> <p>For SIP-T23P/T23G/T21 (P) E2 IP phones:</p> <p>When X=1, the default value is 28 (History).</p> <p>When X=2, the default value is 61 (Directory).</p> <p>When X=3, the default value is 5 (DND).</p> <p>When X=4, the default value is 30 (Menu).</p> <p>When X=5, the default value is 28 (History).</p> <p>When X=6, the default value is 61 (Directory).</p> <p>When X=7, the default value is 0 (NA).</p> <p>When X=8, the default value is 0 (NA).</p> <p>When X=9, the default value is 33 (Status).</p> <p>When X=10, the default value is 0 (NA).</p> <p>When X=14, the default value is 2 (Forward).</p> <p>For SIP-T19(P) E2 IP phones:</p> <p>When X=1, the default value is 28 (History).</p> <p>When X=2, the default value is 61 (Directory).</p> <p>When X=3, the default value is 5 (DND).</p> <p>When X=4, the default value is 30 (Menu).</p> <p>When X=5, the default value is 28 (History).</p> <p>When X=6, the default value is 61 (Directory).</p> <p>When X=7, the default value is 0 (NA).</p> <p>When X=8, the default value is 0 (NA).</p> <p>When X=9, the default value is 33 (Status).</p> <p>When X=13, the default value is 0 (NA).</p> <p>When X=14, the default value is 2 (Forward).</p> <p>For ext keys:</p> <p>When Y=1, the default value is 37 (Switch).</p> <p>When Y= 2 to 20, 22 to 40, the default value is 0 (NA).</p> <p>Web User Interface:</p>		

Parameters	Permitted Values	Default
DSSKey->Line Key/Programable Key->Type Phone User Interface: Menu->Features->DSS Keys->Line Key X->Type		
linekey.X.line/ programablekey.X.line/ expansion_module.X.key.Y.line	Refer to the following content	1-16 for lines 1-16, 1 for programable key
<p>Description:</p> <p>Configures the desired line to apply the group call pickup key.</p> <p>For line keys:</p> <p>X ranges from 1 to 29 (for SIP-T48G).</p> <p>X ranges from 1 to 27 (for SIP-T46G/T29G).</p> <p>X ranges from 1 to 15 (for SIP-T42G/T41P).</p> <p>X ranges from 1 to 21 (for SIP-T27P).</p> <p>X ranges from 1 to 3 (for SIP-T23P/G)</p> <p>X ranges from 1 to 2 (for SIP-T21(P) E2)</p> <p>For programable keys:</p> <p>X=1-10, 12-14 (for SIP-T48G/T46G)</p> <p>X=1-10, 13 (for SIP-T42G/T41P)</p> <p>X=1-14 (for SIP-T29G/T27P)</p> <p>X=1-10, 14 (for SIP-T23P/T23G/T21(P) E2)</p> <p>For ext keys:</p> <p>X ranges from 1 to 6, Y ranges from 1 to 20, 22 to 40 (Ext key 21 cannot be configured).</p> <p>Permitted Values:</p> <p>1 to 16 (for SIP-T48G/T46G/T29G)</p> <p>1 to 12 (for SIP-T42G)</p> <p>1 to 6 (for SIP-T41P/T27P)</p> <p>1 to 3 (for SIP-T23P/G)</p> <p>1 to 2 (for SIP-T21(P) E2)</p> <p>1-Line 1</p> <p>2-Line 2</p> <p>...</p> <p>16-Line 16</p> <p>Note: It is not applicable to SIP-T19(P) E2 IP phones.</p> <p>Example:</p>		

Parameters	Permitted Values	Default
linekey.1.line = 1 Web User Interface: DSSKey->Line Key/ Programable Key->Line Phone User Interface: Menu->Features->DSS Keys->Line Key X->Account ID		
linekey.X.value/ programablekey.X.value/ expansion_module.X.key.Y.value	String within 99 characters	Blank
<p>Description:</p> <p>Configures the group call pickup feature code.</p> <p>For line keys:</p> <p>X ranges from 1 to 29 (for SIP-T48G). X ranges from 1 to 27 (for SIP-T46G/T29G). X ranges from 1 to 15 (for SIP-T42G/T41P). X ranges from 1 to 21 (for SIP-T27P). X ranges from 1 to 3 (for SIP-T23P/G) X ranges from 1 to 2 (for SIP-T21(P) E2)</p> <p>For programable keys:</p> <p>X=1-10, 12-14 (for SIP-T48G/T46G) X=1-10, 13 (for SIP-T42G/T41P) X=1-14 (for SIP-T29G/T27P) X=1-10, 14 (for SIP-T23P/T23G/T21(P) E2) X=1-9, 13, 14 (for SIP-T19(P) E2)</p> <p>For ext keys:</p> <p>X ranges from 1 to 6, Y ranges from 1 to 20, 22 to 40 (Ext key 21 cannot be configured).</p> <p>Example:</p> <p>linekey.2.value = *98</p> <p>Web User Interface:</p> <p>DSSKey->Line Key/ Programable Key->Value</p> <p>Phone User Interface:</p> <p>Menu->Features->DSS Keys->Line Key X->Value</p>		
linekey.X.label/ programablekey.X.label/ expansion_module.X.key.Y.label	String within 99 characters	Blank

Parameters	Permitted Values	Default
<p>Description: (Optional.) Configures the label displayed on the LCD screen for each DSS key. For line keys: X ranges from 1 to 29 (for SIP-T48G) X ranges from 1 to 27 (for SIP-T46G/T29G) X ranges from 1 to 15 (for SIP-T42G/T41P) X ranges from 1 to 21 (for SIP-T27P) X ranges from 1 to 3 (for SIP-T23P/G) X ranges from 1 to 2 (for SIP-T21(P) E2) For programmable keys: X ranges from 1 to 4. For ext keys: X ranges from 1 to 6, Y ranges from 1 to 20, 22 to 40 (Ext key 21 cannot be configured).</p> <p>Web User Interface: DSSKey->Line Key/Programable Key->Label</p> <p>Phone User Interface: Menu->Features->DSS Keys->Line Key X->Label</p>		

To configure a group call pickup key via web user interface:

1. Click on **DSSKey->Line Key** (or **Programable Key**).
2. In the desired DSS key field, select **Group Pickup** from the pull-down list of **Type**.
3. Enter the group call pickup code in the **Value** field.
4. (Optional.) Enter the string that will appear on the LCD screen in the **Label** field.
5. Select the desired line from the pull-down list of **Line**.

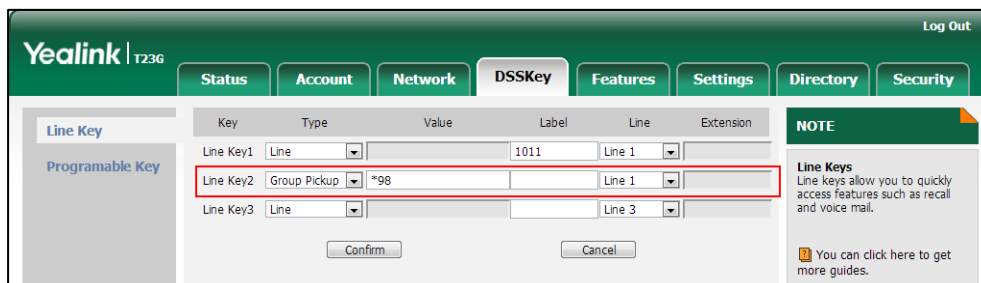

6. Click **Confirm** to accept the change.

To configure the group call pickup code on a per-line basis via web user interface:

1. Click on **Account->Advanced**.

2. Select the desired account from the pull-down list of **Account**.
3. Enter the group call pickup code in the **Group Call Pickup Code** field.

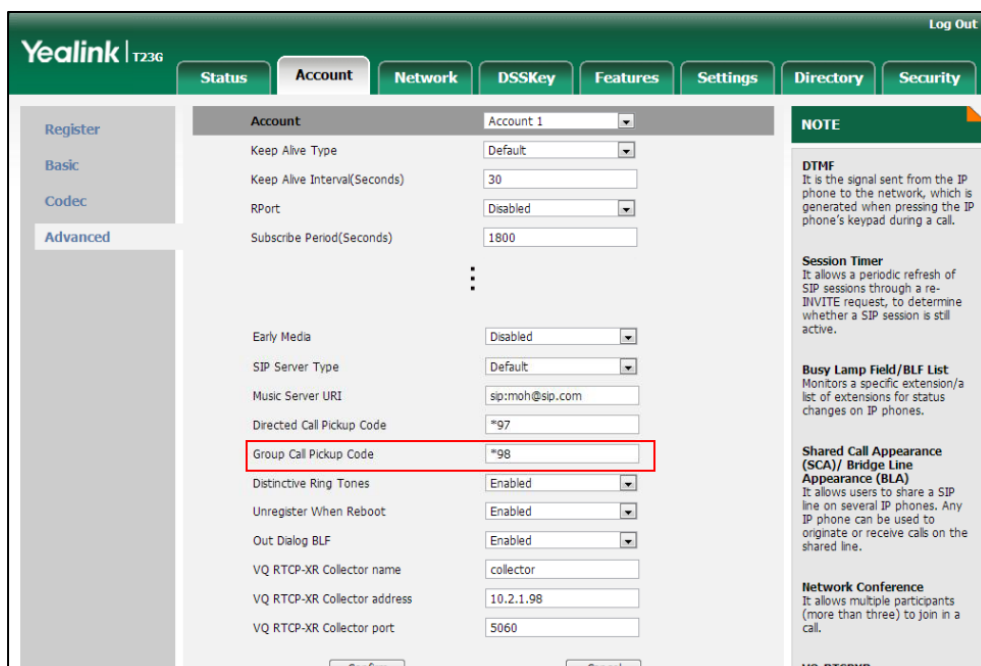

4. Click **Confirm** to accept the change.

To configure group call pickup feature on a phone basis via web user interface:



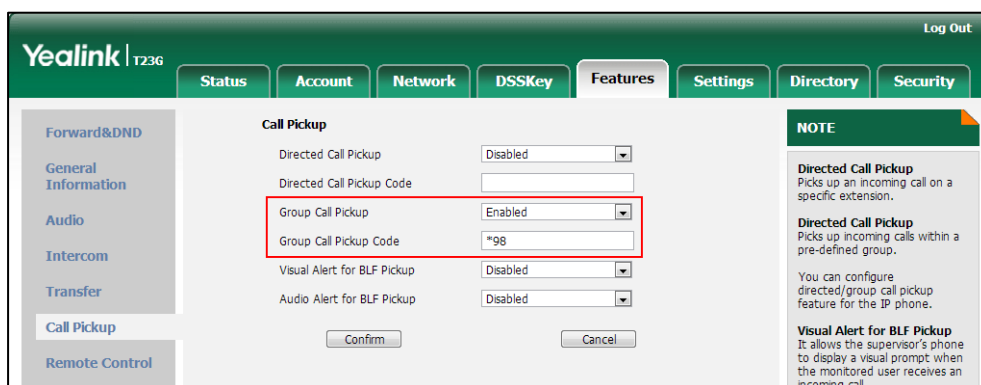

1. Click on **Features->Call Pickup**.
2. Select the desired value from the pull-down list of **Group Call Pickup**.
3. Enter the group call pickup code in the **Group Call Pickup Code** field.



4. Click **Confirm** to accept the change.

To configure a group pickup key via phone user interface:

1. Press **Menu->Features->DSS Keys**.
2. Select the desired DSS key.
3. Press **◀** or **▶**, or the **Switch** soft key to select **Key Event** from the **Type** field.

4. Press  or  , or the **Switch** soft key to select **GPickup** from the **Key Type** field.
5. Press  or  , or the **Switch** soft key to select the desired line from the **Account ID** field.
6. (Optional.) Enter the string that will appear on the LCD screen in the **Label** field.
7. Enter the group call pickup code in the **Value** field.
8. Press the **Save** soft key to accept the change.

Dialog Info Call Pickup

Call pickup is implemented through SIP signals on some specific servers. IP phones support picking up incoming calls via a NOTIFY message with dialog-info event. A user can pick up an incoming call by pressing the DSS key used to monitor a specific extension (such as the BLF key).

Example of the dialog-info message carried in NOTIFY message:

```
<?xml version="1.0"?>
<dialog-info xmlns="urn:ietf:params:xml:ns:dialog-info" version="2" state="partial"
entity="sip:1009@10.3.5.199">
<dialog id="23" call-id="0_3397097402@10.2.20.10" local-tag="16163367" remote-tag="282082771"
direction="initiator">
<state>early</state>
<local>
<identity>sip:1009@10.3.5.199</identity>
<target uri="sip:1009@10.3.5.199">
</local>
<remote>
<identity>sip:1008@10.3.5.199:5060</identity>
<target uri="sip:1008@10.3.5.199:5060">
</remote>
</dialog>
</dialog-info>
```

Procedure

Dialog info call pickup can be configured using the configuration files or locally.

Configuration File	<MAC>.cfg	Configure dialog info call pickup. Parameter: account.X.dialoginfo_callpickup
Local	Web User Interface	Configure dialog info call pickup. Navigate to: http://<phoneIPAddress>/servlet?p=account-adv&q=load&acc=0

Details of the Configuration Parameter:

Parameter	Permitted Values	Default
account.X.dialoginfo_callpickup	0 or 1	0
<p>Description:</p> <p>Enables or disables the IP phone to pick up a call according to the SIP header of dialog-info for account X.</p> <p>0-Disabled 1-Enabled</p> <p>If it is set to 1 (Enabled), call pickup is implemented through SIP signals.</p> <p>X ranges from 1 to 16 (for SIP-T48G/T46G/T29G) X ranges from 1 to 12 (for SIP-T42G) X ranges from 1 to 6 (for SIP-T41P/T27P) X ranges from 1 to 3 (for SIP-T23P/G) X ranges from 1 to 2 (for SIP-T21(P) E2)</p> <p>Note: It is not applicable to SIP-T19(P) E2 IP phones.</p> <p>Web User Interface: Account->Advanced->Dialog Info Call Pickup</p> <p>Phone User Interface: None</p>		

To configure dialog info call pickup via web user interface:

1. Click on **Account->Advanced**.
2. Select the desired account from the pull-down list of **Account**.

3. Select the desired value from the pull-down list of **Dialog Info Call Pickup**.

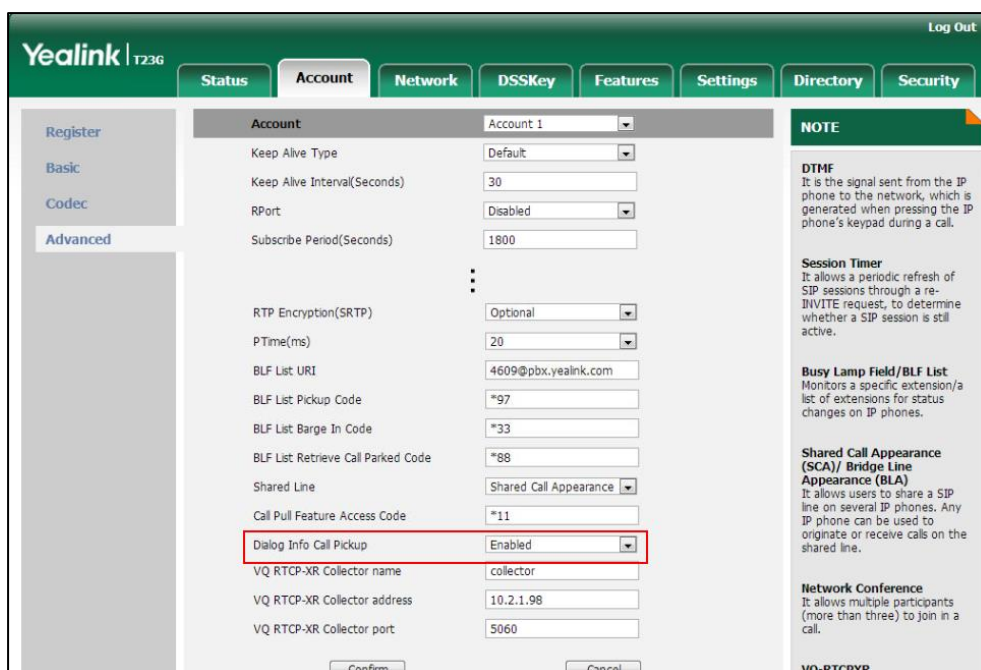

4. Click **Confirm** to accept the change.

Recent Call In Dialing

Recent call in dialing feature allows users to view the placed calls list when the phone is on the pre-dialing screen.

Procedure

Recent call in dialing can be configured using the configuration files or locally.

Configuration File	<y0000000000xx>.cfg	Configure recent call in dialing feature. Parameters: super_search.recent_call
Local	Web User Interface	Configure recent call in dialing feature. Navigate to: http://<phoneIPAddress>/servlet?p=contacts-favorite&q=load

Details of Configuration Parameters:

Parameters	Permitted Values	Default
super_search.recent_call	0 or 1	0

Parameters	Permitted Values	Default
<p>Description: Enables or disables recent call in dialing feature. If it is enabled, you can see the placed calls list when the IP phone is on the pre-dialing screen.</p> <p>0-Disabled 1-Enabled</p> <p>Web User Interface: Directory->Setting->Recent Call In Dialing</p> <p>Phone User Interface: None</p>		

To configure recent call in dialing via web user interface:

1. Click on **Directory->Setting**.
2. Select the desired value from the pull-down list of **Recent Call In Dialing**.

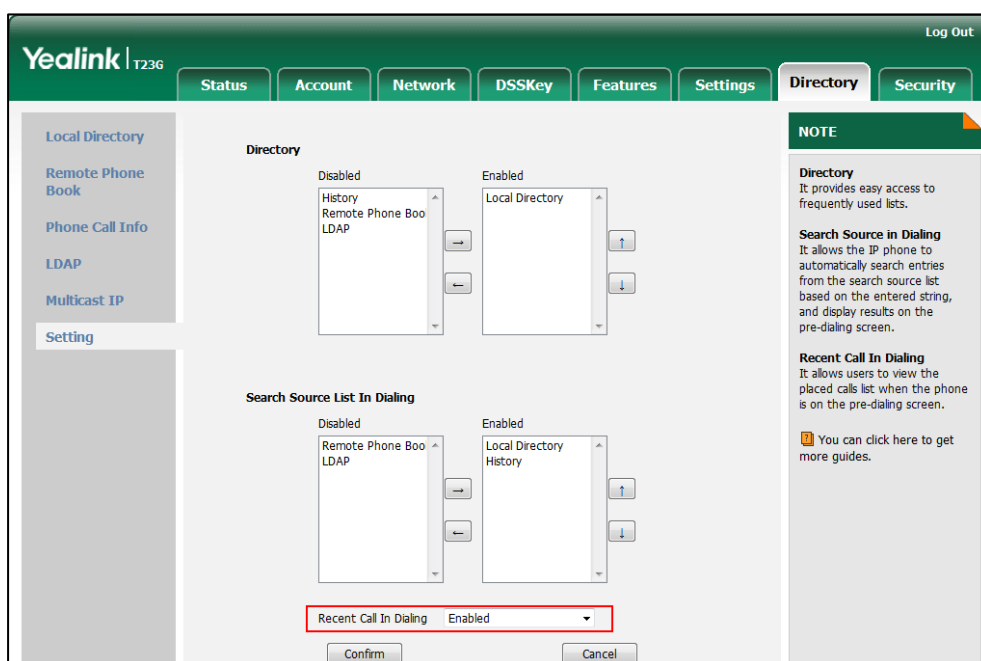

3. Click **Confirm** to accept the change.

ReCall

ReCall, also known as last call return, allows users to place a call back to the last caller. Recall is implemented on IP phones using a recall key.

Procedure

Recall key can be configured using the configuration files or locally.

Configuration File	<y0000000000xx>.cfg	Assign a recall key. Parameter: linekey.X.type/ programablekey.X.type/ expansion_module.X.key.Y.type linekey.X.label/ programablekey.X.label/ expansion_module.X.key.Y.label
Local	Web User Interface	Assign a recall key. Navigate to: http://<phoneIPAddress>/servlet ?p=dsskey&q=load&model=0
	Phone User Interface	Assign a recall key.

ReCall Key

For more information on how to configure the DSS Key, refer to [Appendix D: Configuring DSS Key](#) on page 751.

Parameter	Permitted Values	Default
linekey.X.type/ programablekey.X.type/ expansion_module.X.key.Y.type	7	Refer to the following content
<p>Description: Configures a DSS key as a recall key on the IP phone. The digit 7 stands for the key type ReCall. For line keys: X ranges from 1 to 29 (for SIP-T48G) X ranges from 1 to 27 (for SIP-T46G/T29G) X ranges from 1 to 15 (for SIP-T42G/T41P) X ranges from 1 to 21 (for SIP-T27P) X ranges from 1 to 3 (for SIP-T23P/G) X ranges from 1 to 2 (for SIP-T21(P) E2) For programable keys: X=1-10, 12-14 (for SIP-T48G/T46G) X=1-10, 13 (for SIP-T42G/T41P)</p>		

Parameter	Permitted Values	Default
<p>X=1-14 (for SIP-T29G/T27P)</p> <p>X=1-10, 14 (for SIP-T23P/T23G/T21(P) E2)</p> <p>X=1-9, 13, 14 (for SIP-T19(P) E2)</p> <p>For ext keys:</p> <p>X ranges from 1 to 6, Y ranges from 1 to 20, 22 to 40 (Ext key 21 cannot be configured).</p> <p>Example:</p> <p>linekey.1.type = 7</p> <p>Default:</p> <p>For SIP-T48G IP phones:</p> <p>The default value of the line key 1-16 is 15, and the default value of the line key 17-29 is 0.</p> <p>For SIP-T46G/T29G IP phones:</p> <p>The default value of the line key 1-16 is 15, and the default value of the line key 17-27 is 0.</p> <p>For SIP-T42G IP phones:</p> <p>The default value of the line key 1-12 is 15, and the default value of the line key 13-15 is 0.</p> <p>For SIP-T41P IP phones:</p> <p>The default value of the line key 1-6 is 15, and the default value of the line key 7-15 is 0.</p> <p>For SIP-T27P IP phones:</p> <p>The default value of the line key 1-6 is 15, and the default value of the line key 7-21 is 0.</p> <p>For SIP-T23P/T23G/T21(P) E2 IP phones:</p> <p>The default value is 15.</p> <p>For programable keys:</p> <p>For SIP-T48G/T46G IP phones:</p> <p>When X=1, the default value is 28 (History).</p> <p>When X=2, the default value is 61 (Directory).</p> <p>When X=3, the default value is 5 (DND).</p> <p>When X=4, the default value is 30 (Menu).</p> <p>When X=5, the default value is 28 (History).</p> <p>When X=6, the default value is 61 (Directory).</p> <p>When X=7, the default value is 0 (NA).</p> <p>When X=8, the default value is 0 (NA).</p>		

Parameter	Permitted Values	Default
<p>When X=9, the default value is 33 (Status).</p> <p>When X=10, the default value is 0 (NA).</p> <p>When X=12, the default value is 0 (NA).</p> <p>When X=13, the default value is 0 (NA).</p> <p>When X=14, the default value is 2 (Forward).</p> <p>For SIP-T42G/T41P IP phones:</p> <p>When X=1, the default value is 28 (History).</p> <p>When X=2, the default value is 61 (Directory).</p> <p>When X=3, the default value is 5 (DND).</p> <p>When X=4, the default value is 30 (Menu).</p> <p>When X=5, the default value is 28 (History).</p> <p>When X=6, the default value is 61 (Directory).</p> <p>When X=7, the default value is 0 (NA).</p> <p>When X=8, the default value is 0 (NA).</p> <p>When X=9, the default value is 33 (Status).</p> <p>When X=10, the default value is 0 (NA).</p> <p>When X=13, the default value is 0 (NA).</p> <p>For SIP-T29G/T27P IP phones:</p> <p>When X=1, the default value is 28 (History).</p> <p>When X=2, the default value is 61 (Directory).</p> <p>When X=3, the default value is 5 (DND).</p> <p>When X=4, the default value is 30 (Menu).</p> <p>When X=5, the default value is 28 (History).</p> <p>When X=6, the default value is 61 (Directory).</p> <p>When X=7, the default value is 0 (NA).</p> <p>When X=8, the default value is 0 (NA).</p> <p>When X=9, the default value is 33 (Status).</p> <p>When X=10, the default value is 0 (NA).</p> <p>When X=11, the default value is 0 (NA).</p> <p>When X=12, the default value is 0 (NA).</p> <p>When X=13, the default value is 0 (NA).</p> <p>When X=14, the default value is 2 (Forward).</p> <p>For SIP-T23P/T23G/T21 (P) E2 IP phones:</p> <p>When X=1, the default value is 28 (History).</p> <p>When X=2, the default value is 61 (Directory).</p>		

Parameter	Permitted Values	Default
<p>When X=3, the default value is 5 (DND). When X=4, the default value is 30 (Menu). When X=5, the default value is 28 (History). When X=6, the default value is 61 (Directory). When X=7, the default value is 0 (NA). When X=8, the default value is 0 (NA). When X=9, the default value is 33 (Status). When X=10, the default value is 0 (NA). When X=14, the default value is 2 (Forward).</p> <p>For SIP-T19(P) E2 IP phones:</p> <p>When X=1, the default value is 28 (History). When X=2, the default value is 61 (Directory). When X=3, the default value is 5 (DND). When X=4, the default value is 30 (Menu). When X=5, the default value is 28 (History). When X=6, the default value is 61 (Directory). When X=7, the default value is 0 (NA). When X=8, the default value is 0 (NA). When X=9, the default value is 33 (Status). When X=13, the default value is 0 (NA). When X=14, the default value is 2 (Forward).</p> <p>For ext keys:</p> <p>When Y=1, the default value is 37 (Switch). When Y= 2 to 20, 22 to 40, the default value is 0 (NA).</p> <p>Web User Interface:</p> <p>DSSKey->Line Key/ Programable Key->Type</p> <p>Phone User Interface:</p> <p>Menu->Features->DSS Keys->Line Key X->Type</p>		
<p>linekey.X.label/ programablekey.X.label/ expansion_module.X.key.Y.label</p>	<p>String within 99 characters</p>	<p>Blank</p>
<p>Description:</p> <p>(Optional.) Configures the label displayed on the LCD screen for each DSS key.</p> <p>For line keys: X ranges from 1 to 29 (for SIP-T48G)</p>		

Parameter	Permitted Values	Default
	X ranges from 1 to 27 (for SIP-T46G/T29G)	
	X ranges from 1 to 15 (for SIP-T42G/T41P)	
	X ranges from 1 to 21 (for SIP-T27P)	
	X ranges from 1 to 3 (for SIP-T23P/G)	
	X ranges from 1 to 2 (for SIP-T21(P) E2)	
	For programable keys: X ranges from 1 to 4.	
	For ext keys: X ranges from 1 to 6, Y ranges from 1 to 20, 22 to 40 (Ext key 21 cannot be configured).	
	Web User Interface: DSSKey->Line Key/Programable Key->Label	
	Phone User Interface: Menu->Features->DSS Keys->Line Key X->Label	

To configure a recall key via web user interface:

1. Click on **DSSKey->Line Key** (or **Programable Key**).
2. In the desired DSS key field, select **ReCall** from the pull-down list of **Type**.
3. (Optional.) Enter the string that will appear on the LCD screen in the **Label** field.

The screenshot shows the Yealink T236 web interface. The 'DSSKey' tab is selected. A table lists three line keys: Line Key1, Line Key2, and Line Key3. Line Key2 is highlighted with a red box. Its 'Type' is set to 'ReCall', 'Label' is 'N/A', and 'Line' is 'Line 3'. The 'Value' field is empty. There are 'Confirm' and 'Cancel' buttons at the bottom. A 'NOTE' box on the right states: 'Line Keys allow you to quickly access features such as recall and voice mail. You can click here to get more guides.'

4. Click **Confirm** to accept the change.

To configure a recall key via phone user interface:

1. Press **Menu->Features->DSS Keys**.
2. Select the desired DSS key.
3. Press **◀** or **▶**, or the **Switch** soft key to select **Key Event** from the **Type** field.
4. Press **◀** or **▶**, or the **Switch** soft key to select **ReCall** from the **Key Type** field.
5. (Optional.) Enter the string that will appear on the LCD screen in the **Label** field.
6. Press the **Save** soft key to accept the change.

Call Number Filter

Call number filter feature allows IP phone to automatically filter designated characters when dialing.

Procedure

Call number filter can be configured using the configuration files or locally.

Configuration File	<y0000000000xx>.cfg	Configure the characters the IP phone filters when dialing. Parameters: features.call_num_filter
Local	Web User Interface	Configure the characters the IP phone filters when dialing. Navigate to: http://<phoneIPAddress>/servlet?p=features-general&q=load

Details of Configuration Parameters:

Parameters	Permitted Values	Default
features.call_num_filter	String within 99 characters	,-
<p>Description: Configures the characters the IP phone filters when dialing. If the dialed number contains configured characters, the IP phone will automatically filter these characters when dialing.</p> <p>Example: features.call_num_filter = ,- If you dial 1010%, the IP phone will filter the character % and dial out 1010.</p> <p>Note: If it is left blank, the IP phone will not automatically filter any characters when dialing. If you want to filter just a space, you have to set the value to " ," (a space first followed by a comma).</p> <p>Web User Interface: Features->General Information->Call Number Filter</p> <p>Phone User Interface: None</p>		

To configure the characters the IP phone will filter via web user interface:

1. Click on **Feature->General Information**.

2. Enter the desired characters in the **Call Number Filter** field.

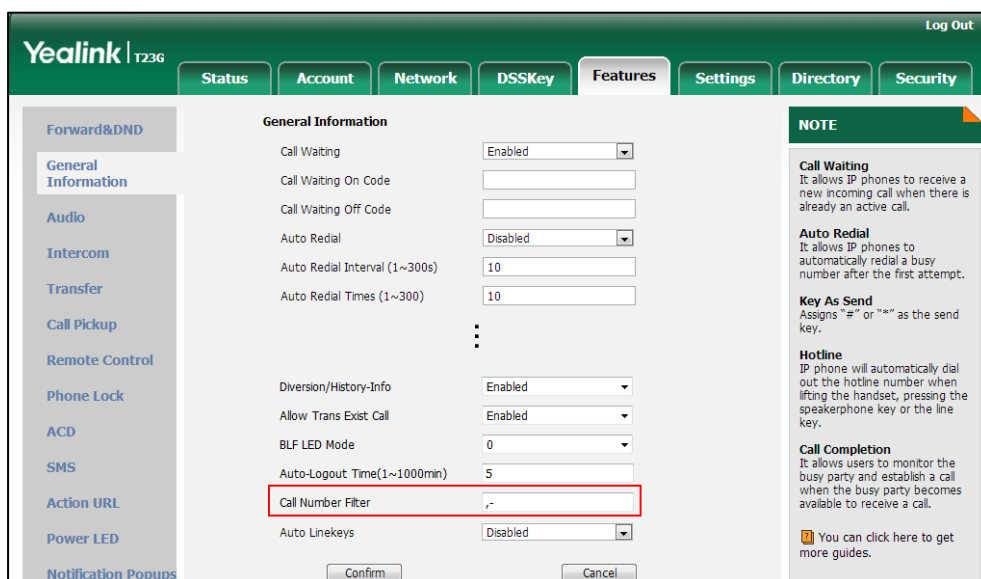

3. Click **Confirm** to accept the change.

Call Park

Call park allows users to park a call on a special extension and then retrieve it on any other phone in the system. Users can park calls on the extension, known as call park orbit, by pressing a call park key. The current call is placed on hold and can be retrieved on another IP phone. This feature depends on support from a SIP server.

Note This feature is not applicable to SIP-T19(P) E2 IP phones.

Procedure

Call park key can be configured using the configuration files or locally.

<p>Configuration File</p>	<p><y0000000000xx>.cfg</p>	<p>Assign a call park key.</p> <p>Parameters:</p> <p>linekey.X.type/ expansion_module.X.key.Y.type</p> <p>linekey.X.line/ expansion_module.X.key.Y.line</p> <p>linekey.X.value/ expansion_module.X.key.Y.value</p> <p>linekey.X.label/ expansion_module.X.key.Y.label</p>
<p>Local</p>	<p>Web User Interface</p>	<p>Assign a call park key.</p>

		Navigate to: <a href="http://<phoneIPAddress>/servlet?p=dsskey&q=load&model=0">http://<phoneIPAddress>/servlet?p=dsskey&q=load&model=0
	Phone User Interface	Assign a call park key.

Call Park Key

For more information on how to configure the DSS Key, refer to [Appendix D: Configuring DSS Key](#) on page 751.

Parameters	Permitted Values	Default
linekey.X.type/ expansion_module.X.key.Y.type	10	Refer to the following content
<p>Description: Configures a DSS key as a call park key on the IP phone. The digit 10 stands for the key type Call Park. For line keys: X ranges from 1 to 29 (for SIP-T48G) X ranges from 1 to 27 (for SIP-T46G/T29G) X ranges from 1 to 15 (for SIP-T42G/T41P) X ranges from 1 to 21 (for SIP-T27P) X ranges from 1 to 3 (for SIP-T23P/G) X ranges from 1 to 2 (for SIP-T21(P) E2) For ext keys: X ranges from 1 to 6, Y ranges from 1 to 20, 22 to 40 (Ext key 21 cannot be configured). Example: linekey.1.type = 10 Default: For SIP-T48G IP phones: The default value of the line key 1-16 is 15, and the default value of the line key 17-29 is 0. For SIP-T46G/T29G IP phones: The default value of the line key 1-16 is 15, and the default value of the line key 17-27 is 0. For SIP-T42G IP phones: The default value of the line key 1-12 is 15, and the default value of the line key 13-15</p>		

Parameters	Permitted Values	Default
<p>is 0.</p> <p>For SIP-T41P IP phones:</p> <p>The default value of the line key 1-6 is 15, and the default value of the line key 7-15 is 0.</p> <p>For SIP-T27P IP phones:</p> <p>The default value of the line key 1-6 is 15, and the default value of the line key 7-21 is 0.</p> <p>For SIP-T23P/T23G/T21(P) E2 IP phones:</p> <p>The default value is 15.</p> <p>For ext keys:</p> <p>When Y=1, the default value is 37 (Switch).</p> <p>When Y= 2 to 20, 22 to 40, the default value is 0 (NA).</p> <p>Note: It is not applicable to SIP-T19(P) E2 IP phones.</p> <p>Web User Interface:</p> <p>DSSKey->Line key->Type</p> <p>Phone User Interface:</p> <p>Menu->Features->DSS Keys->Line Key X->Type</p>		
<p>linekey.X.line/ expansion_module.X.key.Y.line</p>	<p>Refer to the following content</p>	<p>1-16 correspond to the lines 1-16</p>
<p>Description:</p> <p>Configures the desired line to apply the call park key.</p> <p>For line keys:</p> <p>X ranges from 1 to 29 (for SIP-T48G)</p> <p>X ranges from 1 to 27 (for SIP-T46G/T29G)</p> <p>X ranges from 1 to 15 (for SIP-T42G/T41P)</p> <p>X ranges from 1 to 21 (for SIP-T27P)</p> <p>X ranges from 1 to 3 (for SIP-T23P/G)</p> <p>X ranges from 1 to 2 (for SIP-T21(P) E2)</p> <p>For ext keys:</p> <p>X ranges from 1 to 6, Y ranges from 1 to 20, 22 to 40 (Ext key 21 cannot be configured).</p> <p>Permitted Values:</p> <p>1 to 16 (for SIP-T48G/T46G/T29G)</p> <p>1 to 12 (for SIP-T42G)</p> <p>1 to 6 (for SIP-T41P/T27P)</p> <p>1 to 3 (for SIP-T23P/G)</p>		

Parameters	Permitted Values	Default
<p>1 to 2 (for SIP-T21(P) E2)</p> <p>1-Line 1</p> <p>2-Line 2</p> <p>...</p> <p>16-Line 16</p> <p>Example:</p> <p>linekey.1.line = 1</p> <p>Note: It is not applicable to SIP-T19(P) E2 IP phones.</p> <p>Web User Interface:</p> <p>DSSKey->Line key->Line</p> <p>Phone User Interface:</p> <p>Menu->Features->DSS Keys->Line Key X->Account ID</p>		
linekey.X.value/ expansion_module.X.key.Y.value	String within 99 characters	Blank
<p>Description:</p> <p>Configures the call park feature code.</p> <p>For line keys:</p> <p>X ranges from 1 to 29 (for SIP-T48G)</p> <p>X ranges from 1 to 27 (for SIP-T46G/T29G)</p> <p>X ranges from 1 to 15 (for SIP-T42G/T41P)</p> <p>X ranges from 1 to 21 (for SIP-T27P)</p> <p>X ranges from 1 to 3 (for SIP-T23P/G)</p> <p>X ranges from 1 to 2 (for SIP-T21(P) E2)</p> <p>For ext keys:</p> <p>X ranges from 1 to 6, Y ranges from 1 to 20, 22 to 40 (Ext key 21 cannot be configured).</p> <p>Example:</p> <p>linekey.1.value = *88</p> <p>Note: It is not applicable to SIP-T19(P) E2 IP phones.</p> <p>Web User Interface:</p> <p>DSSKey->Line key->Value</p> <p>Phone User Interface:</p> <p>Menu->Features->DSS Keys->Line Key X->Value</p>		
linekey.X.label/ expansion_module.X.key.Y.label	String within 99 characters	Blank

Parameters	Permitted Values	Default
<p>Description: (Optional.) Configures the label displayed on the LCD screen for each DSS key. For line keys: X ranges from 1 to 29 (for SIP-T48G) X ranges from 1 to 27 (for SIP-T46G/T29G) X ranges from 1 to 15 (for SIP-T42G/T41P) X ranges from 1 to 21 (for SIP-T27P) X ranges from 1 to 3 (for SIP-T23P/G) X ranges from 1 to 2 (for SIP-T21(P) E2) For ext keys: X ranges from 1 to 6, Y ranges from 1 to 20, 22 to 40 (Ext key 21 cannot be configured). Note: It is not applicable to SIP-T19(P) E2 IP phones. Web User Interface: DSSKey->Line Key->Label Phone User Interface: Menu->Features->DSS Keys->Line Key X->Label</p>		

To configure a call park key via web user interface:

1. Click on **DSSKey->Line Key**.
2. In the desired DSS key field, select **Call Park** from the pull-down list of **Type**.
3. Enter the desired value (e.g., call park feature code) in the **Value** field.
4. (Optional.) Enter the string that will appear on the LCD screen in the **Label** field.
5. Select the desired line from the pull-down list of **Line**.

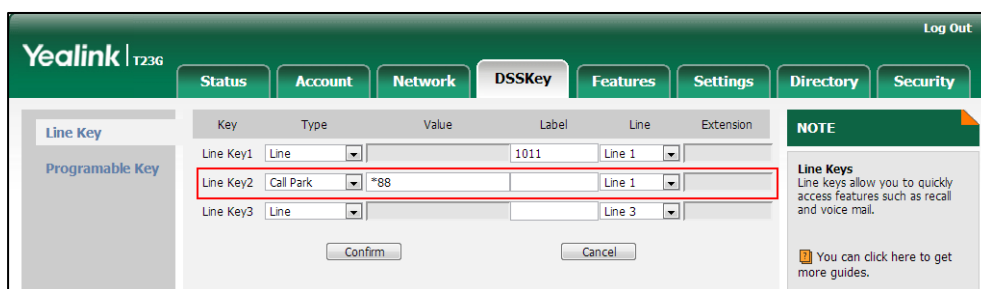

6. Click **Confirm** to accept the change.

To configure a call park key via phone user interface:

1. Press **Menu->Features->DSS Keys**.
2. Select the desired DSS key.

3. Press ◀ or ▶, or the **Switch** soft key to select **Key Event** from the **Type** field.
4. Press ◀ or ▶, or the **Switch** soft key to select **Call Park** from the **Key Type** field.
5. Press ◀ or ▶, or the **Switch** soft key to select the desired line from the **Account ID** field.
6. (Optional.) Enter the string that will appear on the LCD screen in the **Label** field.
7. Enter the desired value (e.g., call park feature code) in the **Value** field.
8. Press the **Save** soft key to accept the change.

Calling Line Identification Presentation

Calling Line Identification Presentation (CLIP) allows IP phones to display the caller identity, derived from a SIP header contained in the INVITE message when receiving an incoming call. IP phones support deriving caller identity from three types of SIP header: From, P-Asserted-Identity (PAI) and Remote-Party-ID (RPID). Identity presentation is based on the identity in the relevant SIP header.

Note If the caller already exists in the local directory, the local contact name assigned to the caller should be preferentially displayed and stored in the call log.

The following sessions show the enhancements of calling line identification presentation according to the calling line identification source configured on the IP phones.

Caller ID source = FROM

- 1) The IP phone checks Privacy: id header preferentially, if there is a Privacy: id in the INVITE request, the calling line identification information will be hidden and the IP phone LCD screen presents anonymous.
- 2) If there is not any Privacy: id header in the INVITE request, the IP phone checks and presents the caller identification from the P-Preferred-Identity header.
- 3) If there is not P-Preferred-Identity header in the INVITE request, the IP phone presents the caller identification derived from the FROM header.

Caller ID source = PAI

- 1) The IP phone checks Privacy: id header preferentially, if there is a Privacy: id in the INVITE request, the caller identification information will be hidden and the IP phone LCD screen presents anonymous.
- 2) If there is not any Privacy: id header in the INVITE request, the IP phone checks and presents the caller identification from the P-Preferred-Identity header.
- 3) If there is not P-Preferred-Identity header in the INVITE request, the IP phone checks and presents the caller identification from the P-Asserted-Identity header.

Caller ID source = PAI-FROM

- 1) The IP phone checks Privacy: id header preferentially, if there is a Privacy: id in the INVITE request, the caller identification information will be hidden and the IP phone LCD screen presents anonymous.
- 2) If there is not any Privacy: id header in the INVITE request, the IP phone checks and presents the caller identification from the P-Preferred-Identity header.
- 3) If there is not P-Preferred-Identity header in the INVITE request, the IP phone checks and presents the caller identification from the P-Asserted-Identity header.
- 4) If there is not P-Asserted-Identity header in the INVITE request, the IP phone presents the caller identification derived from the FROM header.

Caller ID source = RPID-FROM

- 1) The IP phone checks Privacy: id header preferentially, if there is a Privacy: id in the INVITE request, the caller identification information will be hidden and the IP phone LCD screen presents anonymous.
- 2) If there is not any Privacy: id header in the INVITE request, the IP phone checks and presents the caller identification from the P-Preferred-Identity header.
- 3) If there is not P-Preferred-Identity header in the INVITE request, the IP phone checks and presents the caller identification from the Remote-Party-ID header.
- 4) If there is not Remote-Party-ID header in the INVITE request, the IP phone presents the caller identification derived from the FROM header.

Caller ID source = PAI-RPID-FROM

- 1) The IP phone checks Privacy: id header preferentially, if there is a Privacy: id in the INVITE request, the caller identification information will be hidden and the IP phone LCD screen presents anonymous.
- 2) If there is not any Privacy: id header in the INVITE request, the IP phone checks and presents the caller identification from the P-Preferred-Identity header.
- 3) If there is not P-Preferred-Identity header in the INVITE request, the IP phone checks and presents the caller identification from the P-Asserted-Identity header.
- 4) If there is not P-Asserted-Identity header in the INVITE request, the IP phone checks and presents the caller identification from the Remote-Party-ID header.
- 5) If there is not Remote-Party-ID header in the INVITE request, the IP phone presents the caller identification derived from the FROM header.

Caller ID source = RPID-PAI-FROM

- 1) The IP phone checks Privacy: id header preferentially, if there is a Privacy: id in the INVITE request, the caller identification information will be hidden and the IP phone

LCD screen presents anonymous.

- 2) If there is not any Privacy: id header in the INVITE request, the IP phone checks and presents the caller identification from the P-Preferred-Identity header.
- 3) If there is not P-Preferred-Identity header in the INVITE request, the IP phone checks and presents the caller identification from the Remote-Party-ID header.
- 4) If there is not Remote-Party-ID header in the INVITE request, the IP phone checks and presents the caller identification from the P-Asserted-Identity header.
- 5) If there is not P-Asserted-Identity in the INVITE request, the IP phone presents the caller identification derived from the FROM header.

For more information on calling line identification presentation, refer to [Calling and Connected Line Identification Presentation on Yealink IP Phones](#).

Procedure

CLIP can be configured using the configuration files or locally.

<p>Configuration File</p>	<p><MAC>.cfg</p>	<p>Configure the presentation of the caller identity.</p> <p>Parameter: account.X.cid_source</p> <p>Specify whether to process Privacy header field.</p> <p>Parameter: account.X.cid_source_privacy</p> <p>Specify whether to process the P-Preferred-Identity (PPI) header for caller identity presentation.</p> <p>Parameter: account.X.cid_source_ppi</p>
<p>Local</p>	<p>Web User Interface</p>	<p>Configure the presentation of the caller identity.</p> <p>Navigate to: http://<phoneIPAddress>/servlet?p=account-adv&q=load&acc=0</p>

Details of the Configuration Parameter:

Parameter	Permitted Values	Default
account.X.cid_source	0, 1, 2, 3, 4 or 5	0
<p>Description: Configures the presentation of the caller identity when receiving an incoming call for account X.</p> <p>0-FROM 1-PAI 2-PAI-FROM 3-RPID-PAI-FROM 4-PAI-RPID-FROM 5-RPID-FROM</p> <p>X ranges from 1 to 16 (for SIP-T48G/T46G/T29G) X ranges from 1 to 12 (for SIP-T42G) X ranges from 1 to 6 (for SIP-T41P/T27P) X ranges from 1 to 3 (for SIP-T23P/G) X ranges from 1 to 2 (for SIP-T21(P) E2) X is equal to 1 (for SIP-T19(P) E2)</p> <p>Web User Interface: Account->Advanced->Caller ID Source</p> <p>Phone User Interface: None</p>		
account.X.cid_source_privacy	0 or 1	1
<p>Description: Enables or disables the IP phone to process Privacy header field in the SIP message for account X.</p> <p>0-Disabled 1-Enabled</p> <p>X ranges from 1 to 16 (for SIP-T48G/T46G/T29G) X ranges from 1 to 12 (for SIP-T42G) X ranges from 1 to 6 (for SIP-T41P/T27P) X ranges from 1 to 3 (for SIP-T23P/G) X ranges from 1 to 2 (for SIP-T21(P) E2) X is equal to 1 (for SIP-T19(P) E2)</p>		

Parameter	Permitted Values	Default
Web User Interface: None Phone User Interface: None		
account.X.cid_source_ppi	0 or 1	1
Description: Enables or disables the IP phone to process the P-Preferred-Identity (PPI) header for caller identity presentation when receiving an incoming call for account X. 0-Disabled 1-Enabled X ranges from 1 to 16 (for SIP-T48G/T46G/T29G) X ranges from 1 to 12 (for SIP-T42G) X ranges from 1 to 6 (for SIP-T41P/T27P) X ranges from 1 to 3 (for SIP-T23P/G) X ranges from 1 to 2 (for SIP-T21(P) E2) X is equal to 1 (for SIP-T19(P) E2) Web User Interface: None Phone User Interface: None		

To configure the presentation of the caller identity via web user interface:

1. Click on **Account->Advanced**.
2. Select the desired account from the pull-down list of **Account**.

3. Select the desired value from the pull-down list of the **Caller ID Source**.

The screenshot shows the Yealink T236 web interface. The 'Account' tab is selected, and the 'Account' configuration page is displayed. The 'Caller ID Source' field is highlighted with a red box and is set to 'FROM'. Other fields include 'Keep Alive Type' (Default), 'Keep Alive Interval(Seconds)' (30), 'RPort' (Disabled), 'Subscribe Period(Seconds)' (1800), 'DTMF Type' (RFC2833), 'DTMF Info Type' (DTMF-Relay), 'DTMF Payload Type(96~127)' (101), 'Retransmission' (Disabled), 'Subscribe Register' (Disabled), 'Subscribe for MWI' (Disabled), 'MWI Subscription Period(Seconds)' (3600), 'Subscribe MWI To Voice Mail' (Disabled), 'Voice Mail' (empty), and 'Voice Mail Display' (Enabled). A 'NOTE' section on the right provides information about DTMF, Session Timer, Busy Lamp Field/BLF List, and Shared Call Appearance (SCA)/ Bridge Line Appearance (BLA).

4. Click **Confirm** to accept the change.

Connected Line Identification Presentation

Connected Line Identification Presentation (COLP) allows IP phones to display the identity of the connected party specified for outgoing calls. IP phones can display the Dialed Digits, or the identity in a SIP header (Remote-Party-ID or P-Asserted-Identity) received, or the identity in the From header carried in the UPDATE message sent by the callee as described in RFC 4916. Connected line identification presentation is also known as Called line identification presentation. In some cases, the remote party will be different from the called line identification presentation due to call diversion.

Note If the callee already exists in the local directory, the local contact name assigned to the callee should be preferentially displayed.

The following sessions show the enhancements of connected line identification according to the connected line identification source configured on the IP phones.

Connected Line Identification source = PAI-RPID

- 1) The IP phone checks Privacy: id header preferentially, if there is a Privacy: id in the 18X or 200OK response, the connected line identification information will be hidden and the IP phone LCD screen presents anonymous.
- 2) If there is not any Privacy: id header in the 18X or 200OK response, the IP phone checks and presents the connected line identification from the P-Asserted-Identity header.
- 3) If there is not P-Asserted-Identity header in the 18X or 200OK response, the IP phone

presents the connected line identification from the Remote-Party-ID header. If no, the IP phone presents the connected line identification according to the dialed digits.

Connected Line Identification source = Dialed digits

Yealink IP phones present the connected line identification according to the dialed digits.

Connected Line Identification source = RFC4916

Yealink IP phones support to present the connected line identification from UPDATE message following the RFC 4916.

- 1) The IP phone receives an UPDATE message during a call, the connected line identification on the LCD screen should be refreshed according the FROM SIP carried in the UPDATE message.

For more information on connected line identification presentation, refer to [Calling and Connected Line Identification Presentation on Yealink IP Phones](#).

Procedure

COLP can be configured only using the configuration files.

Configuration File	<MAC>.cfg	Configure the presentation of the callee's identity. Parameter: account.X.cp_source Specify whether to process Privacy header field. Parameter: account.X.cid_source_privacy
---------------------------	-----------	---

Details of the Configuration Parameter:

Parameter	Permitted Values	Default
account.X.cp_source	0, 1 or 2	0
Description: Configures the presentation of the callee's identity for account X. 0-PAI-RPID 1-Dialed Digits 2-RFC 4916		

Parameter	Permitted Values	Default
<p>When the RFC 4916 is enabled on the IP phone, the caller sends the SIP request message which contains the from-change tag in the Supported header. The caller then receives an UPDATE message from the callee, and displays the identity in the "From" header.</p> <p>X ranges from 1 to 16 (for SIP-T48G/T46G/T29G)</p> <p>X ranges from 1 to 12 (for SIP-T42G)</p> <p>X ranges from 1 to 6 (for SIP-T41P/T27P)</p> <p>X ranges from 1 to 3 (for SIP-T23P/G)</p> <p>X ranges from 1 to 2 (for SIP-T21(P) E2)</p> <p>X is equal to 1 (for SIP-T19(P) E2)</p> <p>Web User Interface:</p> <p>None</p> <p>Phone User Interface:</p> <p>None</p>		
account.X.cid_source_privacy	0 or 1	1
<p>Description:</p> <p>Enables or disables the IP phone to process Privacy header field in the SIP message for account X.</p> <p>0-Disabled</p> <p>1-Enabled</p> <p>X ranges from 1 to 16 (for SIP-T48G/T46G/T29G)</p> <p>X ranges from 1 to 12 (for SIP-T42G)</p> <p>X ranges from 1 to 6 (for SIP-T41P/T27P)</p> <p>X ranges from 1 to 3 (for SIP-T23P/G)</p> <p>X ranges from 1 to 2 (for SIP-T21(P) E2)</p> <p>X is equal to 1 (for SIP-T19(P) E2)</p> <p>Web User Interface:</p> <p>None</p> <p>Phone User Interface:</p> <p>None</p>		

DTMF

DTMF (Dual Tone Multi-frequency), better known as touch-tone, is used for telecommunication signaling over analog telephone lines in the voice-frequency band.

DTMF is the signal sent from the IP phone to the network, which is generated when pressing the IP phone's keypad during a call. Each key pressed on the IP phone generates one sinusoidal tone of two frequencies. One is generated from a high frequency group and the other from a low frequency group.

The DTMF keypad is laid out in a 4×4 matrix, with each row representing a low frequency, and each column representing a high frequency. Pressing a digit key (such as '1') will generate a sinusoidal tone for each of two frequencies (697 and 1209 hertz (Hz)).

DTMF Keypad Frequencies:

	1209 Hz	1336 Hz	1447 Hz	1633 Hz
697 Hz	1	2	3	A
770 Hz	4	5	6	B
852 Hz	7	8	9	C
941 Hz	*	0	#	D

Methods of Transmitting DTMF Digit

Three methods of transmitting DTMF digits on SIP calls:

- **RFC 2833** -- DTMF digits are transmitted by RTP Events compliant to RFC 2833.
- **INBAND** -- DTMF digits are transmitted in the voice band.
- **SIP INFO** -- DTMF digits are transmitted by SIP INFO messages.

The method of transmitting DTMF digits is configurable on a per-line basis.

RFC 2833

DTMF digits are transmitted using the RTP Event packets that are sent along with the voice path. These packets use RFC 2833 format and must have a payload type that matches what the other end is listening for. The payload type for RTP Event packets is configurable. IP phones default to 101 for the payload type, which use the definition to negotiate with the other end during call establishment.

The RTP Event packet contains 4 bytes. The 4 bytes are distributed over several fields denoted as Event, End bit, R-bit, Volume and Duration. If the End bit is set to 1, the packet contains the end of the DTMF event. You can configure the sending times of the end RTP Event packet.

INBAND

DTMF digits are transmitted within the audio of the IP phone conversation. It uses the same codec as your voice and is audible to conversation partners.

SIP INFO

DTMF digits are transmitted by the SIP INFO messages when the voice stream is established after a successful SIP 200 OK-ACK message sequence. The SIP INFO message is sent along the signaling path of the call. The SIP INFO message can transmit DTMF digits in three ways: DTMF, DTMF-Relay and Telephone-Event.

Procedure

Configuration changes can be performed using the configuration files or locally.

Configuration File	<MAC>.cfg	<p>Configure the method of transmitting DTMF digit and the payload type.</p> <p>Parameters:</p> <p>account.X.dtmf.type account.X.dtmf.dtmf_payload account.X.dtmf.info_type</p>
	<y0000000000xx>.cfg	<p>Configure the number of times for the IP phone to send the end RTP Event packet.</p> <p>Parameter:</p> <p>features.dtmf.repetition</p> <p>Configure the duration time for DTMF.</p> <p>Parameter:</p> <p>features.dtmf.duration</p> <p>Configure the frequency level of DTMF digits.</p> <p>Parameter:</p> <p>features.dtmf.volume</p>
Local	Web User Interface	<p>Configure the method of transmitting DTMF digits and the payload type.</p> <p>Navigate to:</p> <p><a href="http://<phoneIPAddress>/servlet?p=account-adv&q=load&acc=0">http://<phoneIPAddress>/servlet?p=account-adv&q=load&acc=0</p> <p>Configure the number of times for the IP phone to send the end RTP Event packet.</p> <p>Navigate to:</p>

		http://<phoneIPAddress>/servlet?<phoneIPAddress>/servlet?p=features-general&q=loaded
--	--	--

Details of Configuration Parameters:

Parameters	Permitted Values	Default
account.X.dtmf.type	0, 1, 2 or 3	1
<p>Description: Configures the DTMF type for account X.</p> <p>0-INBAND 1-RFC 2833 2-SIP INFO 3-RFC2833 + SIP INFO</p> <p>If it is set to 0 (INBAND), DTMF digits are transmitted in the voice band. If it is set to 1 (RFC 2833), DTMF digits are transmitted by RTP Events compliant to RFC 2833. If it is set to 2 (SIP INFO), DTMF digits are transmitted by the SIP INFO messages. If it is set to 3 (RFC2833 + SIP INFO), DTMF digits are transmitted by RTP Events compliant to RFC 2833 and the SIP INFO messages.</p> <p>X ranges from 1 to 16 (for SIP-T48G/T46G/T29G) X ranges from 1 to 12 (for SIP-T42G) X ranges from 1 to 6 (for SIP-T41P/T27P) X ranges from 1 to 3 (for SIP-T23P/G) X ranges from 1 to 2 (for SIP-T21(P) E2) X is equal to 1 (for SIP-T19(P) E2)</p> <p>Web User Interface: Account->Advanced->DTMF Type</p> <p>Phone User Interface: None</p>		
account.X.dtmf.dtmf_payload	Integer from 96 to 127	101
<p>Description: Configures the value of DTMF payload for account X.</p> <p>X ranges from 1 to 16 (for SIP-T48G/T46G/T29G) X ranges from 1 to 12 (for SIP-T42G)</p>		

Parameters	Permitted Values	Default
<p>X ranges from 1 to 6 (for SIP-T41P/T27P) X ranges from 1 to 3 (for SIP-T23P/G) X ranges from 1 to 2 (for SIP-T21(P) E2) X is equal to 1 (for SIP-T19(P) E2)</p> <p>Note: It works only if the value of parameter “account.X.dtmf.type” is set to 1 (RFC2833) or 3 (RFC2833 + SIP INFO).</p> <p>Web User Interface: Account->Advanced->DTMF Payload Type(96~127)</p> <p>Phone User Interface: None</p>		
account.X.dtmf.info_type	1, 2 or 3	1
<p>Description: Configures the DTMF info type.</p> <p>1-DTMF-Relay 2-DTMF 3-Telephone-Event</p> <p>X ranges from 1 to 16 (for SIP-T48G/T46G/T29G) X ranges from 1 to 12 (for SIP-T42G) X ranges from 1 to 6 (for SIP-T41P/T27P) X ranges from 1 to 3 (for SIP-T23P/G) X ranges from 1 to 2 (for SIP-T21(P) E2) X is equal to 1 (for SIP-T19(P) E2)</p> <p>Note: It works only if the value of parameter “account.X.dtmf.type” is set to 2 (SIP INFO) or 3 (RFC2833 + SIP INFO).</p> <p>Web User Interface: Account->Advanced->DTMF Info Type</p> <p>Phone User Interface: None</p>		
features.dtmf.repetition	1, 2 or 3	3
<p>Description: Configures the repetition times for the IP phone to send the end RTP Event packet during an active call.</p> <p>Web User Interface:</p>		

Parameters	Permitted Values	Default
Features->General Information->DTMF Repetition Phone User Interface: None		
features.dtmf.duration	Integer from 0 to 300	100
Description: Configures the duration time (in milliseconds) for DTMF. Web User Interface: None Phone User Interface: None		
features.dtmf.volume	Integer from -33 to 0	-10
Description: Configures the frequency level of DTMF digits (in db). Web User Interface: None Phone User Interface: None		

To configure the method of transmitting DTMF digits via web user interface:

1. Click on **Account->Advanced**.
2. Select the desired account from the pull-down list of **Account**.
3. Select the desired value from the pull-down list of **DTMF Type**.

If **SIP INFO** or **RFC2833 + SIP INFO** is selected, select the desired value from the pull-down list of **DTMF Info Type**.

- Enter the desired value in the **DTMF Payload Type(96~127)** field.

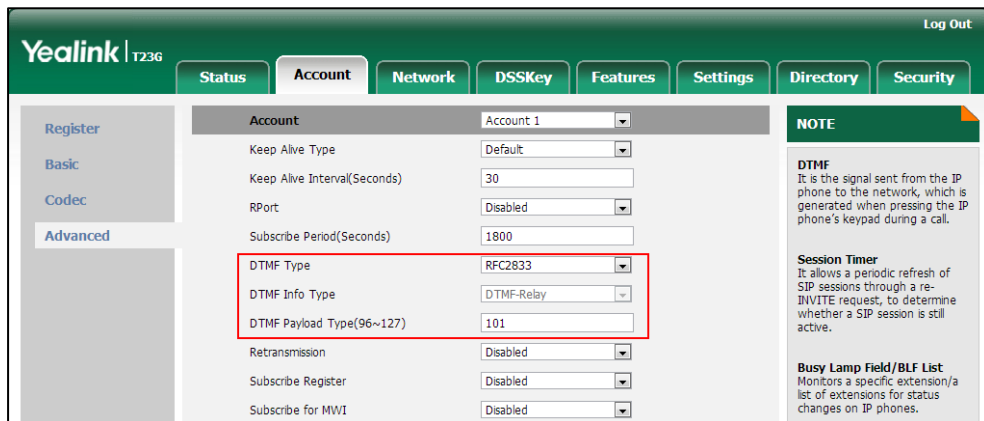

- Click **Confirm** to accept the change.

To configure the number of times to send the end RTP Event packet via web user interface:

- Click on **Features->General Information**.
- Select the desired value (1-3) from the pull-down list of **DTMF Repetition**.

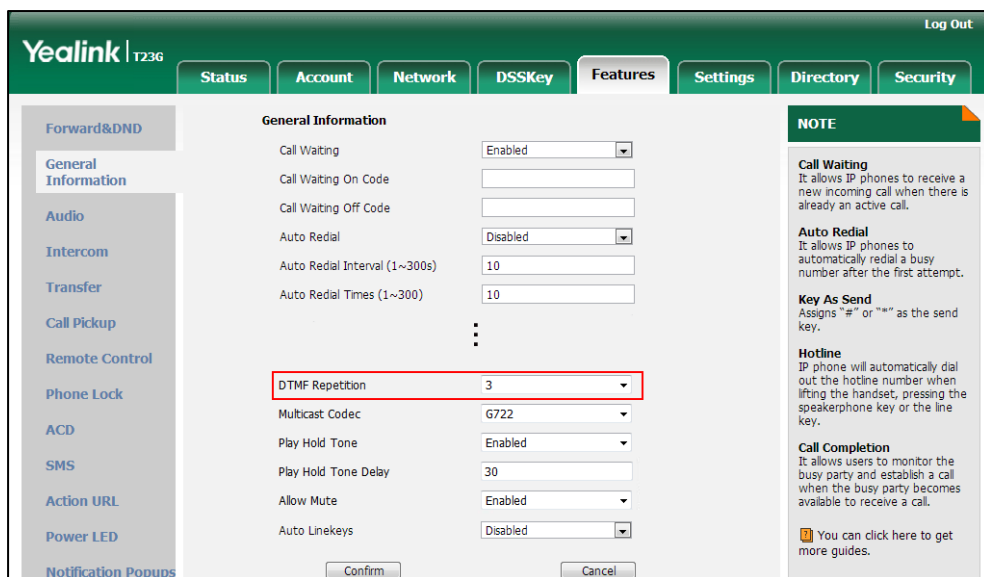

- Click **Confirm** to accept the change.

Suppress DTMF Display

Suppress DTMF display allows IP phones to suppress the display of DTMF digits during an active call. DTMF digits are displayed as “*” on the LCD screen. Suppress DTMF display delay defines whether to display the DTMF digits for a short period of time before displaying as “*”.

Procedure

Configuration changes can be performed using the configuration files or locally.

Configuration File	<y0000000000xx>.cfg	Configure suppress DTMF display and suppress DTMF display delay. Parameters: features.dtmf.hide features.dtmf.hide_delay
Local	Web User Interface	Configure suppress DTMF display and suppress DTMF display delay. Navigate to: http://<phoneIPAddress>/servlet?p=features-general&q=load

Details of Configuration Parameters:

Parameters	Permitted Values	Default
features.dtmf.hide	0 or 1	0
<p>Description: Enables or disables the IP phone to suppress the display of DTMF digits during an active call. 0-Disabled 1-Enabled If it is set to 1 (Enabled), the DTMF digits are displayed as asterisks.</p> <p>Web User Interface: Features->General Information->Suppress DTMF Display</p> <p>Phone User Interface: None</p>		
features.dtmf.hide_delay	0 or 1	0
<p>Description: Enables or disables the IP phone to display the DTMF digits for a short period before displaying asterisks during an active call. 0-Disabled 1-Enabled Note: It works only if the value of the parameter "features.dtmf.hide" is set to 1 (Enabled).</p>		

Parameters	Permitted Values	Default
Web User Interface:		
Features->General Information->Suppress DTMF Display Delay		
Phone User Interface:		
None		

To configure suppress DTMF display and suppress DTMF display delay via web user interface:

1. Click on **Features->General Information**.
2. Select the desired value from the pull-down list of **Suppress DTMF Display**.
3. Select the desired value from the pull-down list of **Suppress DTMF Display Delay**.

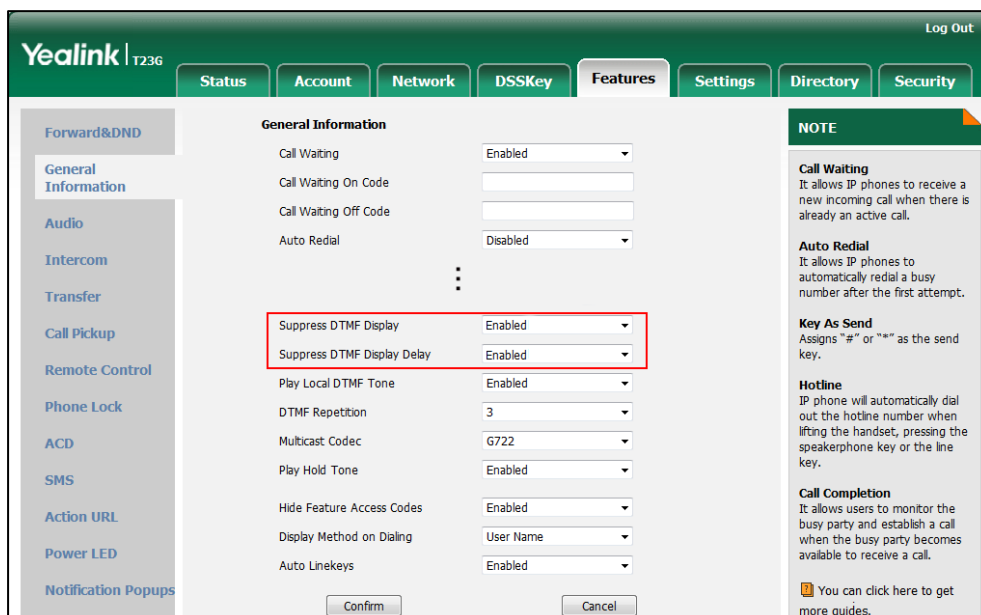

4. Click **Confirm** to accept the change.

Transfer via DTMF

Call transfer is implemented via DTMF on some traditional servers. The IP phone sends specified DTMF digits to the server for transferring calls to third parties.

Procedure

Configuration changes can be performed using the configuration files or locally.

Configuration File	<y0000000000xx>.cfg	Configure transfer via DTMF. Parameters: features.dtmf.replace_tran features.dtmf.transfer
---------------------------	---------------------	--

Local	Web User Interface	Configure transfer via DTMF. Navigate to: <a href="http://<phoneIPAddress>/servlet?<phoneIPAddress>/servlet?p=features-general&q=load">http://<phoneIPAddress>/servlet?p=features-general&q=load
-------	--------------------	---

Details of Configuration Parameters:

Parameters	Permitted Values	Default
features.dtmf.replace_tran	0 or 1	0
<p>Description: Enables or disables the IP phone to send DTMF sequences for transfer function when pressing the Tran/Transfer soft key or TRAN/TRANSFER key.</p> <p>0-Disabled 1-Enabled</p> <p>If it is set to 0 (Disabled), the IP phone will perform the transfer as normal when pressing the Tran/Transfer soft key or TRAN/TRANSFER key during a call.</p> <p>If it is set to 1 (Enabled), the IP phone will transmit the designated DTMF digits to the server for performing call transfer when pressing the Tran/Transfer soft key or TRAN/TRANSFER key during a call.</p> <p>Web User Interface: Features->General Information->DTMF Replace Tran</p> <p>Phone User Interface: None</p>		
features.dtmf.transfer	String within 32 characters	Blank
<p>Description: Configures the DTMF digits to be transmitted to perform call transfer. Valid values are: 0-9, *, # and A-D.</p> <p>Example: features.dtmf.transfer = 123</p> <p>Note: It works only if the value of the parameter "features.dtmf.replace_tran" is set to 1 (Enabled).</p> <p>Web User Interface: Features->General Information->Tran Send DTMF</p> <p>Phone User Interface: None</p>		

To configure transfer via DTMF via web user interface:

1. Click on **Features->General Information**.
2. Select the desired value from the pull-down list of **DTMF Replace Tran**.
3. Enter the specified DTMF digits in the **Tran Send DTMF** field.

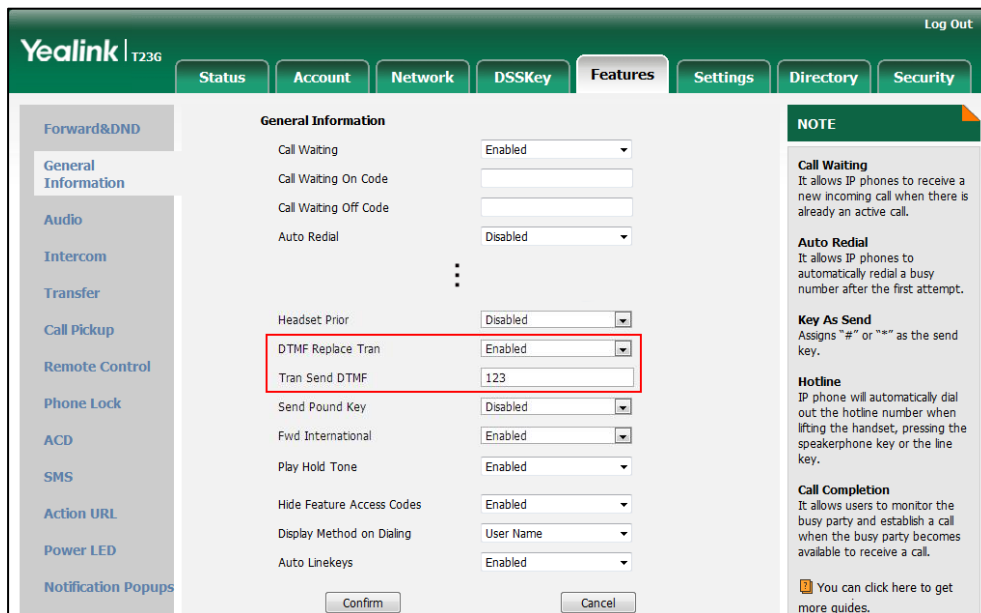

4. Click **Confirm** to accept the change.

Play Local DTMF Tone

Play local DTMF tone allows IP phones to play a local DTMF tone during an active call.

Procedure

Configuration changes can be performed using the configuration files or locally.

<p>Configuration File</p>	<p><y0000000000xx>.cfg</p>	<p>Configure play local DTMF tone.</p> <p>Parameters:</p> <p>features.play_local_dtmf_tone_enable</p>
<p>Local</p>	<p>Web User Interface</p>	<p>Configure play local DTMF tone.</p> <p>Navigate to:</p> <p>http://<phoneIPAddress>/servlet?p=features-general&q=load</p>

Details of Configuration Parameters:

Parameters	Permitted Values	Default
features.play_local_dtmf_tone_enable	0 or 1	1
<p>Description: Enables or disables the IP phone to play a local DTMF tone.</p> <p>0-Disabled 1-Enabled</p> <p>Web User Interface: Features->General Information->Play Local DTMF Tone</p> <p>Phone User Interface: None</p>		

To configure play local DTMF tone via web user interface:

1. Click on **Features->General Information**.
2. Select the desired value from the pull-down list of **Play Local DTMF Tone**.

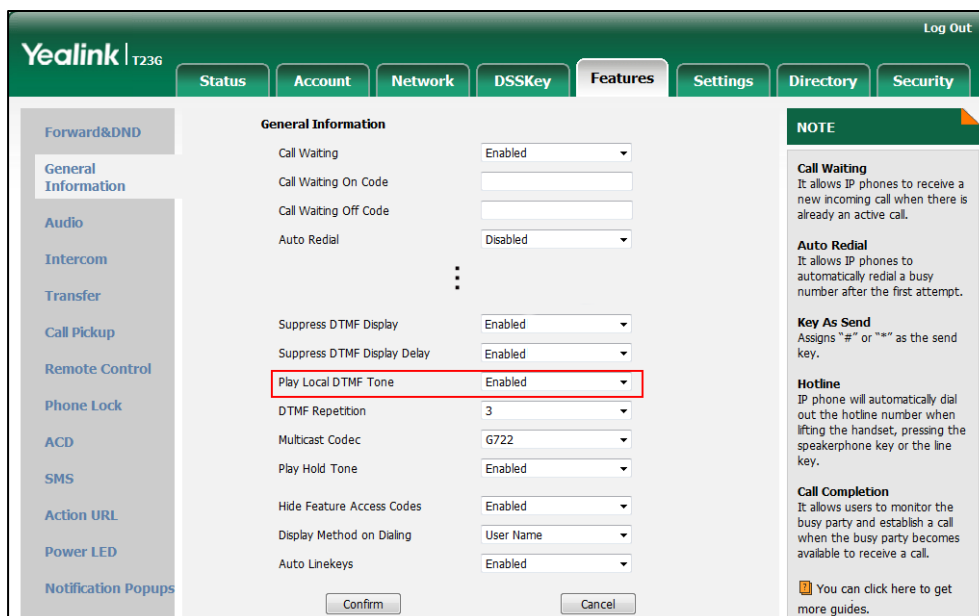

3. Click **Confirm** to accept the change.

Allow Mute

You can mute the microphone of the active audio device during an active call, and then the other party cannot hear you. If allow mute feature is disabled, you cannot mute an active call.

Procedure

Allow mute can be configured using the configuration files or locally.

Configuration File	<y0000000000xx>.cfg	Configure allow mute feature. Parameters: features.allow_mute
Local	Web User Interface	Configure allow mute feature. Navigate to: http://<phoneIPAddress>/servlet?p=features-general&q=load

Details of Configuration Parameters:

Parameters	Permitted Values	Default
features.allow_mute	0 or 1	1
<p>Description: Enables or disables the IP phone to mute an active call.</p> <p>0-Disabled 1-Enabled</p> <p>Web User Interface: Features->General Information->Allow Mute</p> <p>Phone User Interface: None</p>		

To configure allow mute via web user interface:

1. Click on **Feature->General Information**.

2. Select the desired value from the pull-down list of **Allow Mute**.

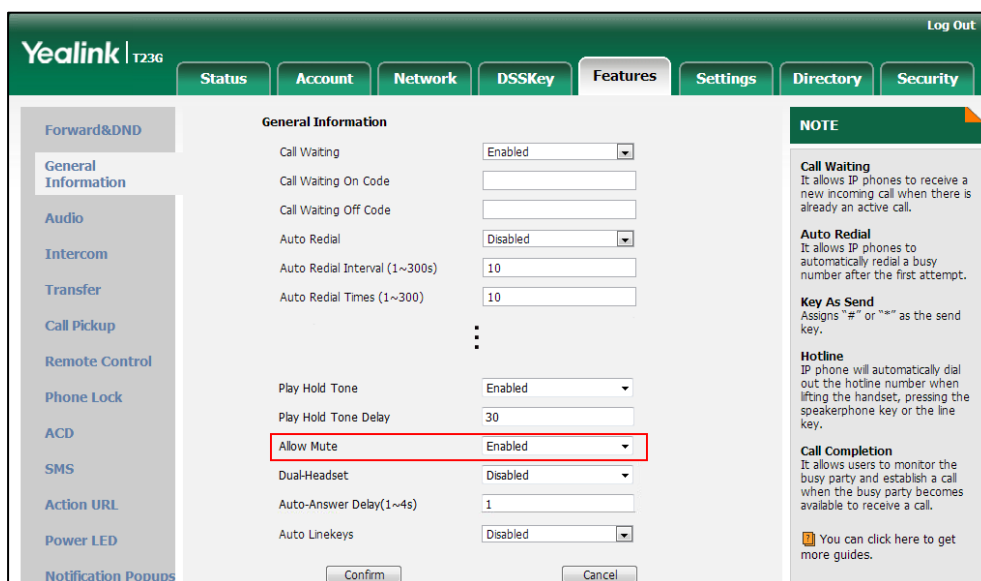

3. Click **Confirm** to accept the change.

Intercom

Intercom allows establishing an audio conversation directly. The IP phone can answer intercom calls automatically. This feature depends on support from a SIP server.

Outgoing Intercom Calls

Intercom is a useful feature in office environments to quickly connect with an operator or secretary. Users can press an intercom key to automatically initiate an outgoing intercom call with a remote extension.

Note This feature is not applicable to SIP-T19(P) E2 IP phones.

Procedure

Intercom key can be configured using the configuration files or locally.

<p>Configuration File</p>	<p><y0000000000xx>.cfg</p>	<p>Assign an intercom key. Parameters: linekey.X.type/ expansion_module.X.key.Y.type linekey.X.line/ expansion_module.X.key.Y.line linekey.X.value/</p>
----------------------------------	----------------------------------	--

		expansion_module.X.key.Y.value linekey.X.label/ expansion_module.X.key.Y.label
Local	Web User Interface	Assign an intercom key. Navigate to: http://<phoneIPAddress>/servlet ?p=dsskey&q=load&model=0
	Phone User Interface	Assign an intercom key.

Intercom Key

For more information on how to configure the DSS Key, refer to [Appendix D: Configuring DSS Key](#) on page 751.

Parameters	Permitted Values	Default
linekey.X.type/ expansion_module.X.key.Y.type	14	Refer to the following content
<p>Description: Configures a DSS key as an intercom key. The digit 14 stands for the key type Intercom. For line keys: X ranges from 1 to 29 (for SIP-T48G) X ranges from 1 to 27 (for SIP-T46G/T29G) X ranges from 1 to 15 (for SIP-T42G/T41P) X ranges from 1 to 21 (for SIP-T27P) X ranges from 1 to 3 (for SIP-T23P/G) X ranges from 1 to 2 (for SIP-T21(P) E2) For ext keys: X ranges from 1 to 6, Y ranges from 1 to 20, 22 to 40 (Ext key 21 cannot be configured).</p> <p>Example: linekey.1.type = 14</p> <p>Default: For line keys: For SIPT48G IP phones: The default value of the line key 1-16 is 15, and the default value of the line key 17-29 is 0.</p>		

Parameters	Permitted Values	Default
<p>For SIP-T46G/T29G IP phones: The default value of the line key 1-16 is 15, and the default value of the line key 17-27 is 0.</p> <p>For SIP-T42G IP phones: The default value of the line key 1-12 is 15, and the default value of the line key 13-15 is 0.</p> <p>For SIP-T41P IP phones: The default value of the line key 1-6 is 15, and the default value of the line key 7-15 is 0.</p> <p>For SIP-T27P IP phones: The default value of the line key 1-6 is 15, and the default value of the line key 7-21 is 0.</p> <p>For SIP-T23P/T23G/T21(P) E2 IP phones: The default value is 15. For ext keys: When Y=1, the default value is 37 (Switch). When Y= 2 to 20, 22 to 40, the default value is 0 (NA). Note: It is not applicable to SIP-T19(P) E2 IP phones.</p> <p>Web User Interface: DSSKey->Line key->Type</p> <p>Phone User Interface: Menu->Features->DSS Keys->Line Key X->Type</p>		
linekey.X.line/ expansion_module.X.key.Y.line	Refer to the following content	1-16 for lines 1-16
<p>Description: Configures the desired line to apply the intercom key. For line keys: X ranges from 1 to 29 (for SIP-T48G) X ranges from 1 to 27 (for SIP-T46G/T29G) X ranges from 1 to 15 (for SIP-T42G/T41P) X ranges from 1 to 21 (for SIP-T27P) X ranges from 1 to 3 (for SIP-T23P/G) X ranges from 1 to 2 (for SIP-T21(P) E2) For ext keys: X ranges from 1 to 6, Y ranges from 1 to 20, 22 to 40 (Ext key 21 cannot be</p>		

Parameters	Permitted Values	Default
<p>configured).</p> <p>Permitted Values:</p> <p>1 to 16 (for SIP-T48G/T46G/T29G) 1 to 12 (for SIP-T42G) 1 to 6 (for SIP-T41P/T27P) 1 to 3 (for SIP-T23P/G) 1 to 2 (for SIP-T21(P) E2)</p> <p>1-Line 1 2-Line 2 ... 16-Line 16</p> <p>Example:</p> <p>linekey.1.line = 1</p> <p>Note: It is not applicable to SIP-T19(P) E2 IP phones.</p> <p>Web User Interface:</p> <p>DSSKey->Line key->Line</p> <p>Phone User Interface:</p> <p>Menu->Features->DSS Keys->Line Key X->Account ID</p>		
linekey.X.value/ expansion_module.X.key.Y.value	String within 99 characters	Blank
<p>Description:</p> <p>Configures the intercom number.</p> <p>For line keys:</p> <p>X ranges from 1 to 29 (for SIPT48G) X ranges from 1 to 27 (for SIPT46G/T29G) X ranges from 1 to 15 (for SIPT42G/T41P) X ranges from 1 to 21 (for SIPT27P) X ranges from 1 to 3 (for SIPT23P/G) X ranges from 1 to 2 (for SIPT21(P) E2)</p> <p>For ext keys:</p> <p>X ranges from 1 to 6, Y ranges from 1 to 20, 22 to 40 (Ext key 21 cannot be configured).</p> <p>Example:</p> <p>linekey.1.value = 1008</p> <p>Note: It is not applicable to SIP-T19(P) E2 IP phones.</p>		

Parameters	Permitted Values	Default
<p>Web User Interface: DSSKey->Line key->Value</p> <p>Phone User Interface: Menu->Features->DSS Keys->Line Key X->Value</p>		
<p>linekey.X.label/ expansion_module.X.key.Y.label</p>	<p>String within 99 characters</p>	<p>Blank</p>
<p>Description: (Optional.) Configures the label displayed on the LCD screen for each DSS key. For line keys: X ranges from 1 to 29 (for SIP-T48G) X ranges from 1 to 27 (for SIP-T46G/T29G) X ranges from 1 to 15 (for SIP-T42G/T41P) X ranges from 1 to 21 (for SIP-T27P) X ranges from 1 to 3 (for SIP-T23P/G) X ranges from 1 to 2 (for SIP-T21(P) E2) For ext keys: X ranges from 1 to 6, Y ranges from 1 to 20, 22 to 40 (Ext key 21 cannot be configured). Note: It is not applicable to SIP-T19(P) E2 IP phones.</p> <p>Web User Interface: DSSKey->Line Key->Label</p> <p>Phone User Interface: Menu->Features->DSS Keys->Line Key X->Label</p>		

To configure an intercom key via web user interface:

1. Click on **DSSKey->Line Key**.
2. In the desired DSS key field, select **Intercom** from the pull-down list of **Type**.
3. Enter the remote extension number in the **Value** field.
4. (Optional.) Enter the string that will appear on the LCD screen in the **Label** field.

5. Select the desired line from the pull-down list of **Line**.

Key	Type	Value	Label	Line	Extension
Line Key1	Line		1011	Line 1	
Line Key2	Intercom	1008		Line 1	
Line Key3	Line			Line 3	

6. Click **Confirm** to accept the change.

To configure an intercom key via phone user interface:

1. Press **Menu->Features->DSS Keys**.
2. Select the desired DSS key.
3. Press **◀** or **▶**, or the **Switch** soft key to select **Intercom** from the **Type** field.
4. Select the desired line from the **Account ID** field.
5. (Optional.) Enter the string that will appear on the LCD screen in the **Label** field.
6. Enter the remote extension number in the **Value** field.
7. Press the **Save** soft key to accept the change.

Incoming Intercom Calls

The IP phone can process incoming calls differently depending on settings. There are four configuration options for incoming intercom calls:

Accept Intercom

Accept Intercom allows the IP phone to answer an incoming intercom call.

Intercom Mute

Intercom Mute allows the IP phone to mute the microphone for incoming intercom calls.

Intercom Tone

Intercom Tone allows the IP phone to play a warning tone before answering an intercom call.

Intercom Barge

Intercom Barge allows the IP phone to automatically answer an incoming intercom call while an active call is in progress. The active call will be placed on hold.

If you disable this feature, the IP phone will handle an incoming intercom call like a waiting call while there is already an active call on the IP phone.

Procedure

Incoming intercom calls can be configured using the configuration files or locally.

Configuration File	<y0000000000xx>.cfg	Configure incoming intercom call feature. Parameters: features.intercom.allow features.intercom.mute features.intercom.tone features.intercom.barge
Local	Web User Interface	Configure incoming intercom call feature. Navigate to: http://<phoneIPAddress>/servlet?p=features-intercom&q=load
	Phone User Interface	Configure incoming intercom call feature.

Details of Configuration Parameters:

Parameters	Permitted Values	Default
features.intercom.allow	0 or 1	1
<p>Description: Enables or disables the IP phone to answer an incoming intercom call.</p> <p>0-Disabled 1-Enabled</p> <p>If it is set to 0 (Disabled), the IP phone will reject incoming intercom calls and sends a busy signal to the caller.</p> <p>If it is set to 1 (Enabled), the IP phone will automatically answer an incoming intercom call.</p> <p>Web User Interface: Features->Intercom->Accept Intercom</p> <p>Phone User Interface: Menu->Features->Intercom->Accept Intercom</p>		
features.intercom.mute	0 or 1	0
Description:		

Parameters	Permitted Values	Default
<p>Enables or disables the IP phone to mute the microphone when answering an intercom call.</p> <p>0-Disabled 1-Enabled</p> <p>If it is set to 1 (Enabled), the microphone is muted for intercom calls, and then the other party cannot hear you.</p> <p>Note: It works only if the value of the parameter “features.intercom.allow” is set to 1 (Enabled).</p> <p>Web User Interface: Features->Intercom->Intercom Mute</p> <p>Phone User Interface: Menu->Features->Intercom->Intercom Mute</p>		
features.intercom.tone	0 or 1	1
<p>Description:</p> <p>Enables or disables the IP phone to play a warning tone when answering an intercom call.</p> <p>0-Disabled 1-Enabled</p> <p>Note: It works only if the value of the parameter “features.intercom.allow” is set to 1 (Enabled).</p> <p>Web User Interface: Features->Intercom->Intercom Tone</p> <p>Phone User Interface: Menu->Features->Intercom->Intercom Tone</p>		
features.intercom.barge	0 or 1	0
<p>Description:</p> <p>Enables or disables the IP phone to answer an incoming intercom call while there is already an active call on the IP phone.</p> <p>0-Disabled 1-Enabled</p> <p>If it is set to 0 (Disabled), the IP phone will handle an incoming intercom call like a waiting call while there is already an active call on the IP phone.</p> <p>If it is set to 1 (Enabled), the IP phone will automatically answer the intercom call while there is already an active call on the IP phone and place the active call on</p>		

Parameters	Permitted Values	Default
<p>hold.</p> <p>Note: It works only if the value of the parameter "features.intercom.allow" is set to 1 (Enabled) and "call_waiting.enable" are set to 1 (Enabled).</p> <p>Web User Interface: Features->Intercom->Intercom Barge</p> <p>Phone User Interface: Menu->Features->Intercom->Intercom Barge</p>		

To configure intercom via web user interface:

1. Click on **Features->Intercom**.
2. Select the desired values from the pull-down lists of **Accept Intercom, Intercom Mute, Intercom Tone and Intercom Barge**.

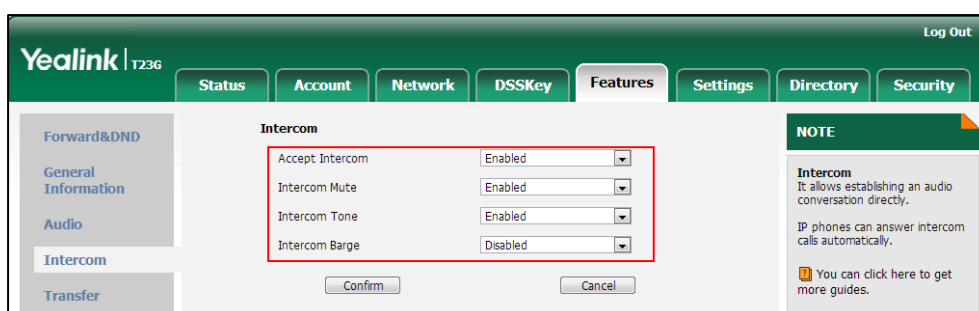

3. Click **Confirm** to accept the change.

To configure intercom via phone user interface:

1. Press **Menu->Features->Intercom**.
2. Press **◀** or **▶** , or the **Switch** soft key to select the desired values from the **Accept Intercom, Intercom Mute, Intercom Tone and Intercom Barge** fields.
3. Press the **Save** soft key to accept the change.

Call Timeout

Call timeout defines a specific period of time within which the IP phone will cancel the dialing if the call is not answered.

Procedure

Call timeout can only be configured using the configuration files.

Configuration File	<y0000000000xx>.cfg	Configure the duration time (in seconds) in the ringback state.
---------------------------	---------------------	---

		Parameters: phone_setting.ringback_timeout
--	--	--

Details of the Configuration Parameter:

Parameter	Permitted Values	Default
phone_setting.ringback_timeout	Integer from 0 to 3600	180
Description: It configures the duration time (in seconds) in the ringback state. If it is set to 180, the phone will cancel the dialing if the call is not answered within 180s. Web User Interface: None Phone User Interface: None		

Ringing Timeout

Ringing timeout defines a specific period of time within which the IP phone will stop ringing if the call is not answered.

Procedure

Ringing timeout can only be configured using the configuration files.

Configuration File	<y0000000000xx>.cfg	Configure the duration time (in seconds) in the ringing state. Parameters: phone_setting.ringing_timeout
---------------------------	---------------------	---

Details of the Configuration Parameter:

Parameter	Permitted Values	Default
phone_setting.ringing_timeout	Integer from 0 to 3600	180

Parameter	Permitted Values	Default
<p>Description:</p> <p>It configures the duration time (in seconds) in the ringing state.</p> <p>If it is set to 180, the phone will stop ringing if the call is not answered within 180s.</p> <p>Web User Interface:</p> <p>None</p> <p>Phone User Interface:</p> <p>None</p>		

Send user=phone

When placing a call, the IP phone will send an INVITE request to the proxy server. Send user=phone feature allows adding user=phone to the SIP header of the INVITE message.

Example of a SIP INVITE message:

```
INVITE sip:101@10.3.5.199:5060;user=phone SIP/2.0
Via: SIP/2.0/UDP 10.3.20.6:5060;branch=z9hG4bK2475812834
From: "1010" <sip:1010@10.3.5.199:5060>;tag=3747068208
To: <sip:101@10.3.5.199:5060;user=phone>
Call-ID: 0_4008470062@10.3.20.6
CSeq: 1 INVITE
Contact: <sip:1010@10.3.20.6:5060>
Content-Type: application/sdp
Allow: INVITE, INFO, PRACK, ACK, BYE, CANCEL, OPTIONS, NOTIFY, REGISTER, SUBSCRIBE, REFER, PUBLISH, UPDATE, MESSAGE
Max-Forwards: 70
User-Agent: Yealink SIP-T23G 44.80.0.20
Allow-Events: talk,hold,conference,refer,check-sync
Content-Length: 300
```

Procedure

Send user=phone can be configured using the configuration files or locally.

Configuration File	<code><MAC>.cfg</code>	<p>Configure send user=phone feature on a per-line basis.</p> <p>Parameters:</p> <p>account.X.enable_user_equal_ph one</p>
---------------------------	------------------------------	---

Local	Web User Interface	Configure send user=phone feature on a per-line basis. Navigate to: http://<phoneIPAddress>/servlet?p=account-adv&q=load&acc=0
-------	--------------------	---

Details of the Configuration Parameter:

Parameter	Permitted Values	Default
account.X.enable_user_equal_phone	0 or 1	0
<p>Description: Enables or disables the IP phone to add "user=phone" to the SIP header of the INVITE message for account X.</p> <p>0-Disabled 1-Enabled</p> <p>X ranges from 1 to 16 (for SIP-T48G/T46G/T29G) X ranges from 1 to 12 (for SIP-T42G) X ranges from 1 to 6 (for SIP-T41P/T27P) X ranges from 1 to 3 (for SIP-T23P/G) X ranges from 1 to 2 (for SIP-T21(P) E2) X is equal to 1 (for SIP-T19(P) E2)</p> <p>Web User Interface: Account->Advanced->Send user=phone</p> <p>Phone User Interface: None</p>		

To configure send user=phone feature via web user interface:

1. Click on **Account->Advanced**.
2. Select the desired account from the pull-down list of **Account**.

3. Select the desired value from the pull-down list of **Send user=phone**.

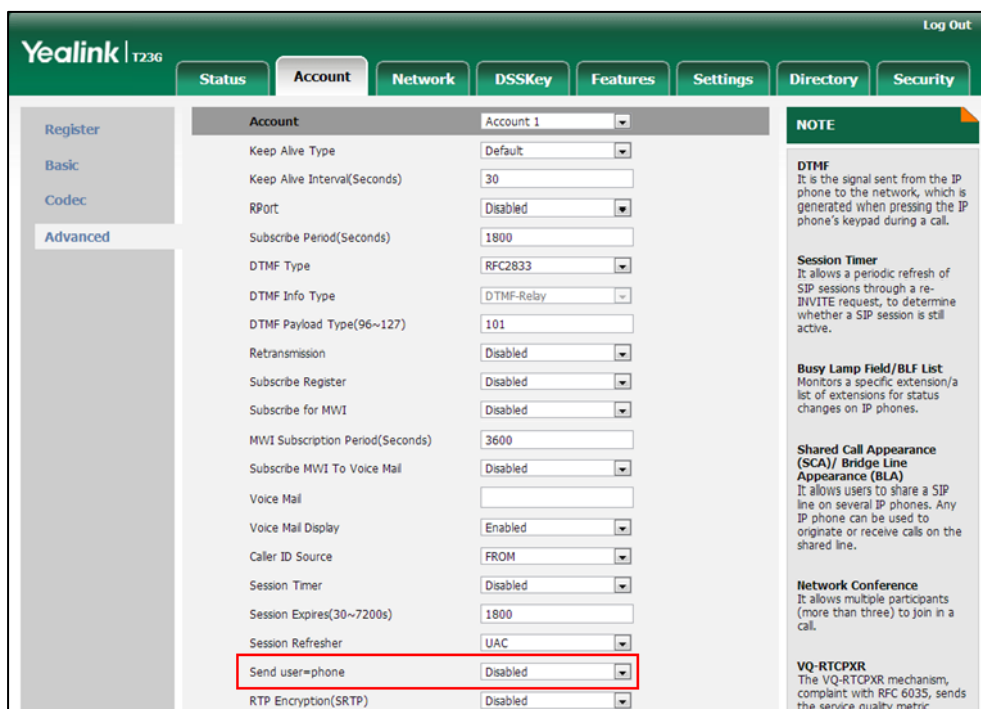

4. Click **Confirm** to accept the change.

SIP Send MAC

The IP phone can send the MAC address in the REGISTER message. SIP send MAC allow adding "Mac:<PhoneMACAddress>" (e.g., Mac: 00:15:65:74:b1:50) to the SIP header of the REGISTER message.

Example of a SIP REGISTER message:

```
REGISTER sip:10.3.5.199:5060 SIP/2.0
Via: SIP/2.0/UDP 10.3.20.14:5060;branch=z9hG4bK3593117201
From: "11" <sip:11@10.3.5.199:5060>;tag=2788360609
To: "11" <sip:11@10.3.5.199:5060>
Call-ID: 1_1863786852@10.3.20.14
CSeq: 2 REGISTER
Contact: <sip:11@10.3.20.14:5060;line=cc75882e976e208>
Allow: INVITE, INFO, PRACK, ACK, BYE, CANCEL, OPTIONS, NOTIFY, REGISTER, SUBSCRIBE, REFER,
PUBLISH, UPDATE, MESSAGE
Max-Forwards: 70
User-Agent: Yealink SIP-T23G 44.80.0.20
Expires: 0
Allow-Events: talk,hold,conference,refer,check-sync
Mac: 00:15:65:74:b1:50
```

Content-Length: 0

Procedure

SIP send MAC can be configured using the configuration files or locally.

Configuration File	<MAC>.cfg	Configure SIP send MAC on a per-line basis. Parameters: account.X.register_mac
Local	Web User Interface	Configure SIP send MAC on a per-line basis. Navigate to: http://<phoneIPAddress>/servlet?p=account-adv&q=load&acc=0

Details of the Configuration Parameter:

Parameter	Permitted Values	Default
account.X.register_mac	0 or 1	0
<p>Description: Enables or disables the IP phone to add MAC address to the SIP header of the REGISTER message for account X. 0-Disabled 1-Enabled X ranges from 1 to 16 (for SIP-T48G/T46G/T29G) X ranges from 1 to 12 (for SIPT42G) X ranges from 1 to 6 (for SIP-T41P/T27P) X ranges from 1 to 3 (for SIP-T23P/G) X ranges from 1 to 2 (for SIP-T21(P) E2) X is equal to 1 (for SIPT19(P) E2)</p> <p>Web User Interface: Account->Advanced->SIP Send MAC</p> <p>Phone User Interface: None</p>		

To configure SIP send MAC feature via web user interface:

1. Click on **Account->Advanced**.
2. Select the desired account from the pull-down list of **Account**.

3. Select the desired value from the pull-down list of **SIP Send MAC**.

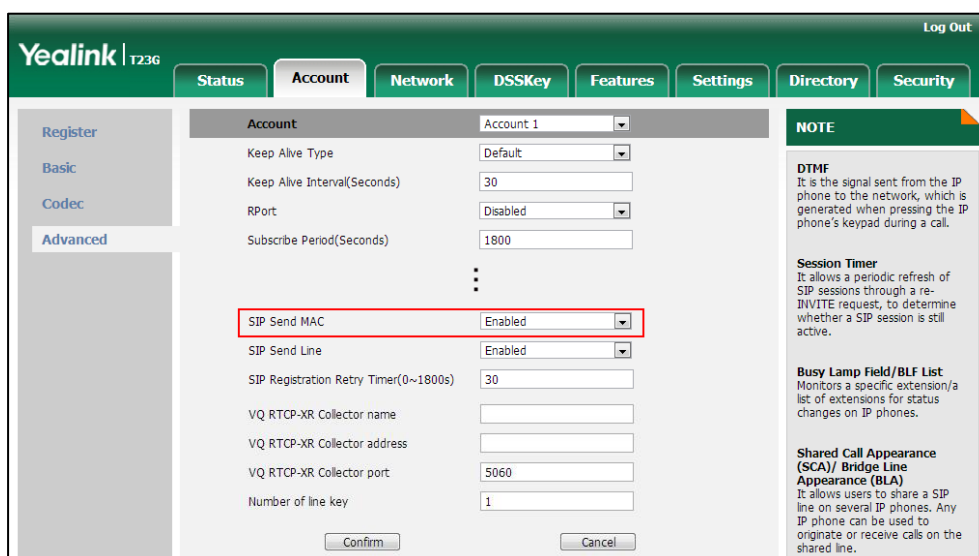

4. Click **Confirm** to accept the change.

SIP Send Line

The IP phone can send the line number in the REGISTER message. SIP send line allow adding "Line:<linenumber>" (e.g., Line: 1) to the SIP header of the REGISTER message. The line number is a number between 0 and 15.

The following table lists line number values for each phone model.

Phone Model	Values	Description
SIP-T48G/T46G/T29G	0~15	0~15 stand for line1~line16
SIP-T42G	0~11	0~11 stand for line1~line12
SIP-T41P/T27P	0~5	0~5 stand for line1~line6
SIP-T23P/G	0~2	0~2 stand for line1~line3
SIP-T21(P) E2	0~1	0~1 stand for line1~line2
SIP-T19(P) E2	0	0 stand for line1

Example of a SIP REGISTER message:

```
REGISTER sip:10.3.5.199:5060 SIP/2.0
Via: SIP/2.0/UDP 10.3.20.14:5060;branch=z9hG4bK3990593443
From: "11" <sip:11@10.3.5.199:5060>;tag=255071842
To: "11" <sip:11@10.3.5.199:5060>
Call-ID: 1_2369214377@10.3.20.14
CSeq: 2 REGISTER
Contact: <sip:11@10.3.20.14:5060;line=1da6aa8d7254654>
```

```

Allow: INVITE, INFO, PRACK, ACK, BYE, CANCEL, OPTIONS, NOTIFY, REGISTER, SUBSCRIBE, REFER,
PUBLISH, UPDATE, MESSAGE
Max-Forwards: 70
User-Agent: Yealink SIP-T23G 44.80.0.20
Expires: 0
Allow-Events: talk,hold,conference,refer,check-sync
Line: 1
Content-Length: 0
    
```

Procedure

SIP send line can be configured using the configuration files or locally.

Configuration File	<MAC>.cfg	Configure SIP send line on a per-line basis. Parameters: account.X.register_line
Local	Web User Interface	Configure SIP send line on a per-line basis. Navigate to: http://<phoneIPAddress>/servlet? p=account-adv&q=load&acc=0

Details of the Configuration Parameter:

Parameter	Permitted Values	Default
account.X.register_line	0 or 1	0
<p>Description: Enables or disables the IP phone to add line number to the SIP header of the REGISTER message for account X.</p> <p>0-Disabled 1-Enabled</p> <p>X ranges from 1 to 16 (for SIP-T48G/T46G/T29G) X ranges from 1 to 12 (for SIP-T42G) X ranges from 1 to 6 (for SIP-T41P/T27P) X ranges from 1 to 3 (for SIP-T23P/G) X ranges from 1 to 2 (for SIP-T21(P) E2) X is equal to 1 (for SIP-T19(P) E2)</p> <p>Web User Interface: Account->Advanced->SIP Send Line</p>		

Parameter	Permitted Values	Default
Phone User Interface:		
None		

To configure SIP send Line feature via web user interface:

1. Click on **Account->Advanced**.
2. Select the desired account from the pull-down list of **Account**.
3. Select the desired value from the pull-down list of **SIP Send Line**.

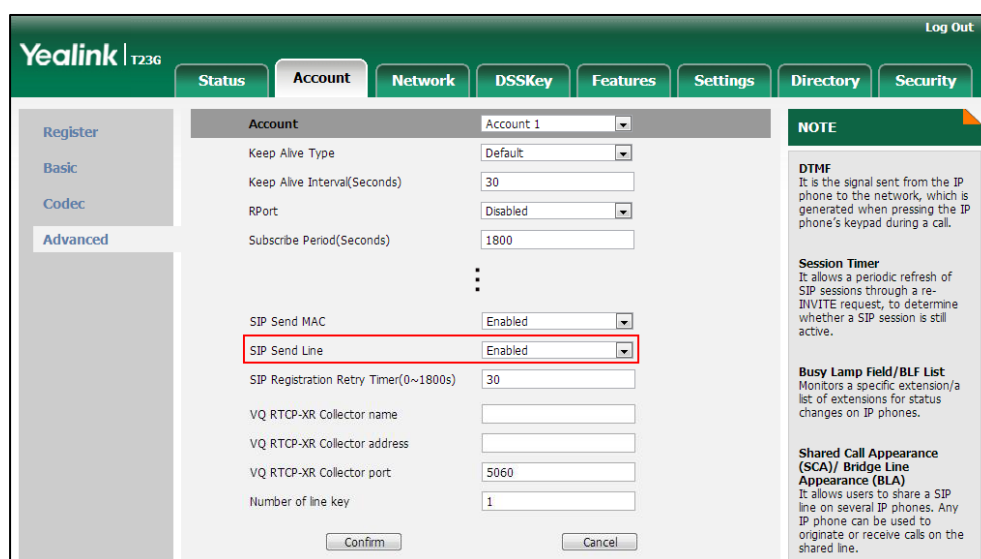

4. Click **Confirm** to accept the change.

Reserve # in User Name

Reserve # in User Name feature allows IP phones to reserve “#” in user name. When Reserve # in User Name feature is disabled, “#” will be converted into “%23”. For example, the user registers an account (user name: 1010#) on the phone, the phone will send 1010%23 instead of 1010# in the REGISTER message or INVITE message to SIP server.

Example of a SIP REGISTER message:

```
INVITE sip:2@10.3.5.199:5060 SIP/2.0
Via: SIP/2.0/UDP 10.3.20.6:5060;branch=z9hG4bK1867789050
From: "1010" <sip:1010%23@10.3.5.199:5060>;tag=1945988802
To: <sip:2@10.3.5.199:5060>
Call-ID: 0_2336101648@10.3.20.6
CSeq: 1 INVITE
Contact: <sip:1010%23@10.3.20.6:5060>
Content-Type: application/sdp
```

Allow: INVITE, INFO, PRACK, ACK, BYE, CANCEL, OPTIONS, NOTIFY, REGISTER, SUBSCRIBE, REFER, PUBLISH, UPDATE, MESSAGE
 Max-Forwards: 70
 User-Agent: Yealink SIP-T23G 44.80.0.20
 Allow-Events: talk,hold,conference,REFER,check-sync
 Content-Length: 300

Procedure

Reserve # in User Name can be configured using the configuration files or locally.

Configuration File	<y0000000000xx>.cfg	Configure reserve # in user name. Parameters: sip.use_23_as_pound
Local	Web User Interface	Configure reserve # in user name. Navigate to: http://<phoneIPAddress>/servlet?p=features-general&q=load

Details of the Configuration Parameter:

Parameter	Permitted Values	Default
sip.use_23_as_pound	0 or 1	1
<p>Description: Enables or disables the IP phone to reserve the pound sign (#) in the user name. 0-Disabled (convert the pound sign into "%23") 1-Enabled</p> <p>Web User Interface: Features->General Information->Reserve # in User Name</p> <p>Phone User Interface: None</p>		

To configure reserve # in user name feature via web user interface:

1. Click on **Features->General Information**.

2. Select the desired value from the pull-down list of **Reserve # in User Name**.

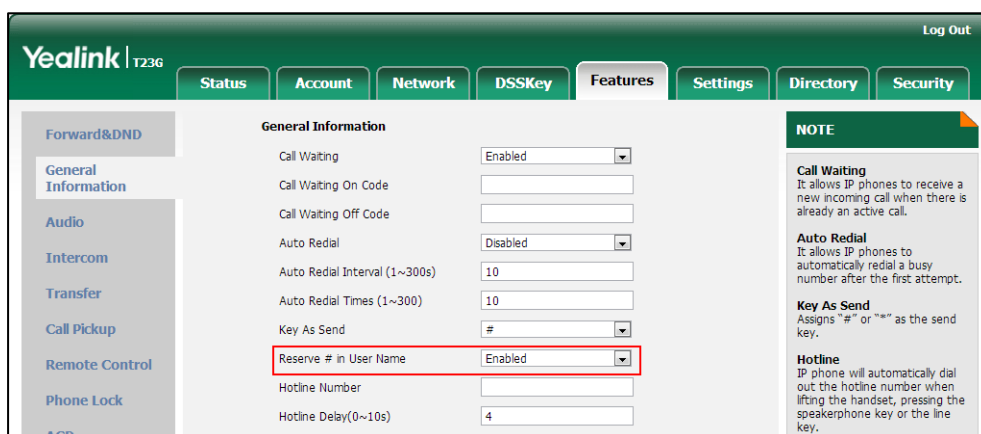

3. Click **Confirm** to accept the change.

Password Dial

Password dial feature allows the callee number to be partly displayed on the IP phone when placing a call. The hidden digits are displayed as asterisks on the LCD screen. This feature is especially useful for users always placing important and confidential calls.

Procedure

Password dial feature can be configured using the configuration files or locally.

Configuration File	<y0000000000xx>.cfg	Configure password dial feature. Parameters: features.password_dial.enable features.password_dial.prefix features.password_dial.length
Local	Web User Interface	Configure password dial feature. Navigate to: http://<phoneIPAddress>/servlet? p=features-general&q=load

Details of the Configuration Parameter:

Parameter	Permitted Values	Default
<code>features.password_dial.enable</code>	0 or 1	0
<p>Description: Enables or disables password dial feature for the IP phone.</p> <p>0-Disabled 1-Enabled</p> <p>Web User Interface: Features->General Information->PswDial</p> <p>Phone User Interface: None</p>		
<code>features.password_dial.prefix</code>	String within 32 characters	Blank
<p>Description: Configures the prefix of the password dial number.</p> <p>Example: <code>features.password_dial.prefix = 12</code></p> <p>Web User Interface: Features->General Information->PswPrefix</p> <p>Phone User Interface: None</p>		
<code>features.password_dial.length</code>	Integer from 0 to 99	Blank
<p>Description: Configures the number of digits to be hidden. The hidden digits are displayed as asterisks on the LCD screen.</p> <p>Example: <code>features.password_dial.length = 3</code></p> <p>Note: If you set the prefix to 12 and the length to 3, when you want to dial the number 123456, the entered number is displayed as 12***6 on the LCD screen.</p> <p>Web User Interface: Features->General Information->PswLength</p> <p>Phone User Interface: None</p>		

To configure password dial feature via web user interface:

1. Click on **Features->General Information**.
2. Select the desired value from the pull-down list of **PswDial**.
3. Enter the prefix of password dial in the **PswPrefix** field.
4. Enter the desired number of hidden digits in the **PswLength** field.

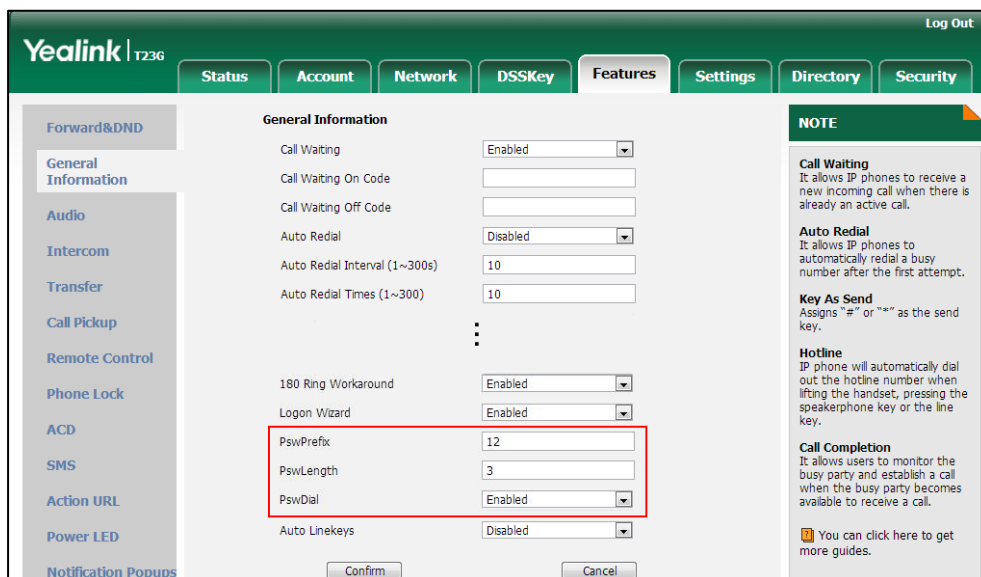

5. Click **Confirm** to accept the change.

Unregister When Reboot

Unregister when reboot feature allows IP phones to unregister first before re-registering the account when finishing a reboot.

Procedure

Unregister when reboot can be configured using the configuration files or locally.

Configuration File	<MAC>.cfg	Configure unregister when reboot. Parameters: account.X.unregister_on_reboot
Local	Web User Interface	Configure unregister when reboot. Navigate to: http://<phoneIPAddress>/servlet?p=account-adv&q=load&acc=0

Details of the Configuration Parameter:

Parameter	Permitted Values	Default
account.X.unregister_on_reboot	0 or 1	0
<p>Description: Enables or disables the IP phone to unregister first before re-registering account X when finishing a reboot.</p> <p>0-Disabled 1-Enabled</p> <p>X ranges from 1 to 16 (for SIP-T48G/T46G/T29G) X ranges from 1 to 12 (for SIP-T42G) X ranges from 1 to 6 (for SIP-T41P/T27P) X ranges from 1 to 3 (for SIP-T23P/G) X ranges from 1 to 2 (for SIP-T21(P) E2) X is equal to 1 (for SIP-T19(P) E2)</p> <p>Web User Interface: Account->Advanced->Unregister When Reboot</p> <p>Phone User Interface: None</p>		

To configure unregister when reboot via web user interface:

1. Click on **Account->Advanced**.
2. Select the desired account from the pull-down list of **Account**.

3. Select the desired value from the pull-down list of **Unregister When Reboot**.

The screenshot shows the Yealink T236 web interface with the 'Account' tab selected. The 'Unregister When Reboot' option is highlighted with a red box and is set to 'Enabled'. Other settings include 'Keep Alive Type' (Default), 'Keep Alive Interval(Seconds)' (30), 'RPort' (Disabled), 'Subscribe Period(Seconds)' (1800), 'Early Media' (Disabled), 'SIP Server Type' (Default), 'Music Server URI' (sip:moh@sip.com), 'Directed Call Pickup Code' (*97), 'Group Call Pickup Code' (*98), 'Distinctive Ring Tones' (Enabled), 'Out Dialog BLF' (Enabled), 'VQ RTPC-XR Collector name' (collector), 'VQ RTPC-XR Collector address' (10.2.1.98), and 'VQ RTPC-XR Collector port' (5060). A 'NOTE' section on the right provides information about DTMF, Session Timer, Busy Lamp Field/BLF List, Shared Call Appearance (SCA)/ Bridge Line Appearance (BLA), and Network Conference.

4. Click **Confirm** to accept the change.

100 Reliable Retransmission

As described in [RFC 3262](#), 100rel tag is for reliability of provisional responses. When present in a Supported header, it indicates that the IP phone can send or receive reliable provisional responses. When present in a Require header in a reliable provisional response, it indicates that the response is to be sent reliably.

Example of a SIP INVITE message:

```
INVITE sip:1024@pbx.yealink.com:5060 SIP/2.0
Via: SIP/2.0/UDP 10.3.6.197:5060;branch=z9hG4bK1708689023
From: "1025" <sip:1025@pbx.yealink.com:5060>;tag=1622206783
To: <sip:1024@pbx.yealink.com:5060>
Call-ID: 0_537569052@10.3.6.197
CSeq: 2 INVITE
Contact: <sip:1025@10.3.6.197:5060>
Authorization: Digest username="1025", realm="pbx.yealink.com",
nonce="BroadWorksXi5stub71Ts2nb05BW", uri="sip:1024@pbx.yealink.com:5060",
response="f7e9d35c55af45b3f89beae95e913171", algorithm=MD5, cnonce="0a4f113b", qop=auth,
nc=00000001
Content-Type: application/sdp
Allow: INVITE, INFO, PRACK, ACK, BYE, CANCEL, OPTIONS, NOTIFY, REGISTER, SUBSCRIBE, REFER,
PUBLISH, UPDATE, MESSAGE
Max-Forwards: 70
```

```
User-Agent: Yealink SIP-T23G 44.80.0.20
Supported: 100rel
Allow-Events: talk,hold,conference,refer,check-sync
Content-Length: 302
```

Procedure

100 Reliable Retransmission can be configured using the configuration files or locally.

Configuration File	<MAC>.cfg	Configure the 100 reliable retransmission feature. Parameters: account.X.100rel_enable
Local	Web User Interface	Configure the 100 reliable retransmission feature. Navigate to: http://<phoneIPAddress>/servlet? p=account-adv&q=load&acc=0

Details of the Configuration Parameter:

Parameter	Permitted Values	Default
account.X.100rel_enable	0 or 1	0
<p>Description: Enables or disables the 100 reliable retransmission feature for account X.</p> <p>0-Disabled 1-Enabled</p> <p>X ranges from 1 to 16 (for SIP-T48G/T46G/T29G) X ranges from 1 to 12 (for SIP-T42G) X ranges from 1 to 6 (for SIP-T41P/T27P) X ranges from 1 to 3 (for SIP-T23P/G) X ranges from 1 to 2 (for SIP-T21(P) E2) X is equal to 1 (for SIP-T19(P) E2)</p> <p>Web User Interface: Account->Advanced->Retransmission</p> <p>Phone User Interface: None</p>		

To configure 100 reliable retransmission via web user interface:

1. Click on **Account->Advanced**.
2. Select the desired account from the pull-down list of **Account**.
3. Select the desired value from the pull-down list of **Retransmission**.

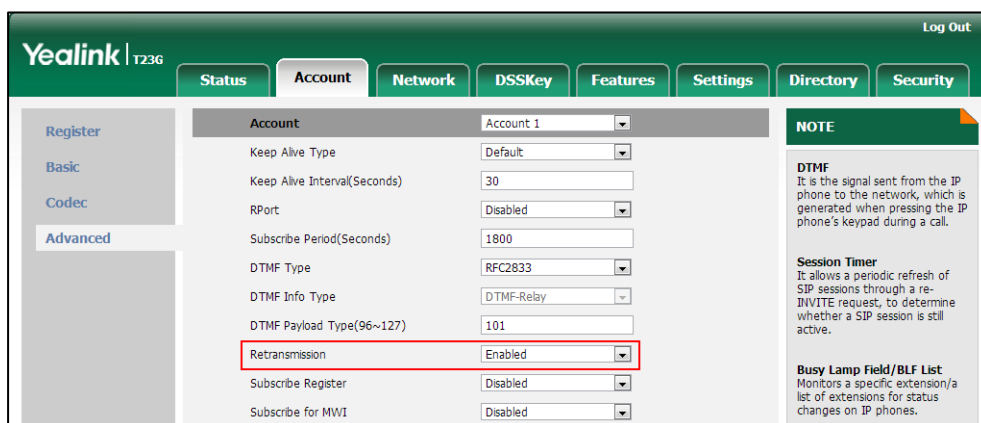

4. Click **Confirm** to accept the change.

Reboot in Talking

Reboot in talking feature allows IP phones to reboot during an active call when it receives a reboot request by action URI. For more information on action URI, refer to [Action URI](#) on page 527.

IP phones do not receive and handle HTTP/HTTPS GET requests by default. To use this feature, you need to specify the trusted IP address(es) for action URI in advance. For more information, refer to [Configuring Trusted IP Address for Action URI](#) on page 530.

Procedure

Reboot in talking can be configured using the configuration files or locally.

Configuration File	<y0000000000xx>.cfg	Configure reboot in talking. Parameter: features.reboot_in_talk_enable
Local	Web User Interface	Configure reboot in talking. Navigate to: http://<phoneIPAddress>/servlet ?p=features-general&q=load

Details of Configuration Parameters:

Parameter	Permitted Values	Default
features.reboot_in_talk_enable	0 or 1	0

Description:
 Enables or disables the phone to reboot during a call when it receives a reboot request by action URI.

0-Disabled
1-Enabled

Note: It works only if the value of the parameter “features.action_uri_limit_ip” is set to “any” or trusted IP address(es) and it is not the first time for the IP phone to receive HTTP/HTTPS GET request from the trusted IP address(es).

Web User Interface:
 Features->General Information->Reboot in Talking

Phone User Interface:
 None

To configure reboot in talking via web user interface:

1. Click on **Features->General Information**.
2. Select the desired value from the pull-down list of **Reboot in Talking** field.

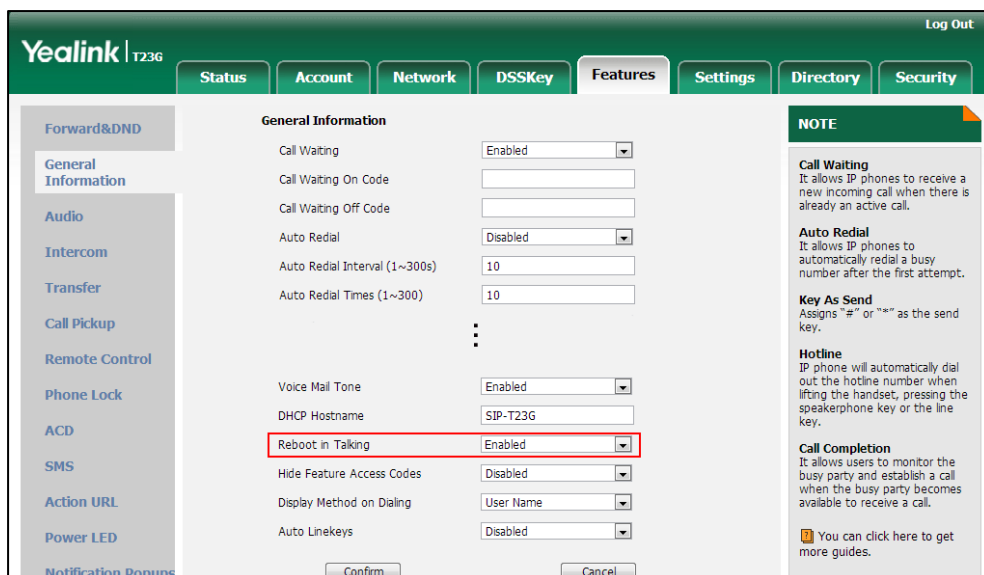

3. Click **Confirm** to accept the change.
 A dialog box pops up to prompt that settings will take effect after a reboot.
4. Click **OK** to reboot the phone.

Configuring Advanced Features

This chapter provides information for making configuration changes for the following advanced features:

- [Remote Phone Book](#)
- [LDAP](#)
- [Busy Lamp Field](#)
- [BLF List](#)
- [Hide Features Access Code](#)
- [Automatic Call Distribution \(ACD\)](#)
- [Shared Call Appearance \(SCA\)](#)
- [Bridge Lines Appearance \(BLA\)](#)
- [Message Waiting Indicator](#)
- [Short Message Service \(SMS\)](#)
- [Multicast Paging](#)
- [Call Recording](#)
- [Hot Desking](#)
- [Logon Wizard](#)
- [Action URL](#)
- [Action URI](#)
- [Server Redundancy](#)
- [Static DNS Cache](#)
- [VLAN](#)
- [VPN](#)
- [Voice Quality Monitoring](#)
- [Quality of Service](#)
- [Network Address Translation](#)
- [Real-Time Transport Protocol](#)
- [TR-069 Device Management](#)
- [IPv6 Support](#)

Remote Phone Book

Remote phone book is a centrally maintained phone book, stored on the remote server. Users only need the access URL of the remote phone book. The IP phone can establish a connection with the remote server and download the phone book, and then display the remote phone book entries on the phone user interface. IP phones support up to 5 remote phone books. Remote phone book is customizable.

Customizing Remote Phone Book Template File

You can customize the remote phone book for IP phones as required. You can also add multiple remote contacts at a time and/or share remote contacts between IP phones using the supplied template files (Menu.xml and Department.xml). The Menu.xml file defines departments of a remote phone book. The Department.xml file defines contact lists for a department, which is nested in Menu.xml file. After setup, place the files (Menu.xml and Department.xml) to the provisioning server, and specify the access URL of the file (Menu.xml) in the configuration files.

You can ask the distributor or Yealink FAE for remote XML phone book template. You can also obtain the remote XML phone book template online:

<http://support.yealink.com/documentFront/forwardToDocumentFrontDisplayPage>. For more information on obtaining the remote phone book template, refer to [Obtaining Configuration Files and Resource Files](#) on page 42.

When creating a Department.xml file, learn the following:

- `<YealinkIPPhoneDirectory>` indicates the start of a department file and `</YealinkIPPhoneDirectory>` indicates the end of a department file.
- Create contact lists for a department between `<DirectoryEntry>` and `</DirectoryEntry>`.

To customize a Department.xml file:

1. Open the template file using an ASCII editor.
2. For each contact that you want to add, add the following strings to the file. Each starts on a separate line:

```
<Name> Test1</Name>  
<Telephone> 23000</Telephone>
```

Where:

Specify the contact name between <Name> and </Name>.

Specify the contact number between <Telephone> and </Telephone>.

```

1 <YealinkIPPhoneDirectory>
2
3
4 <DirectoryEntry>
5   <Name>Test1</Name>
6   <Telephone>23000</Telephone>
7 </DirectoryEntry>
8
9
10 <DirectoryEntry>
11   <Name>Test2</Name>
12   <Telephone>303</Telephone>
13   <Telephone>915980830849</Telephone>
14 </DirectoryEntry>
15
16
17
18 <DirectoryEntry>
19   <Name>Test3</Name>
20   <Telephone>6650</Telephone>
21   <Telephone>915980830849</Telephone>
22 </DirectoryEntry>
23
24 </YealinkIPPhoneDirectory>

```

3. Save the file and place this file to the provisioning server.

When creating a Menu.xml file, learn the following:

- <YealinkIPPhoneMenu> indicates the start of a remote phone book file and </YealinkIPPhoneMenu> indicates the end of a remote phone book file.
- Create the title of a remote phone book between <Title> and </Title>.
- <MenuItem> indicates the start of specifying a department file and </MenuItem> indicates the end of specifying a department file.
- <SoftKeyItem> indicates the start of specifying a XML file and </SoftKeyItem> indicates the end of specifying a XML file.

To customize a Menu.xml file:

1. Open the template file using an ASCII editor.
2. For each department that you want to add, add the following strings to the file. Each starts on a separate line:

```

<MenuItem>
<Name>Department1</Name>

```

```
<URL> http://10.2.9.1:99/Department.xml</URL>
</MenuItem>
```

```

1 <YealinkIPPhoneMenu>
2 <Title>XiaMen Yealink</Title>
3
4 <MenuItem>
5 <Name>Department1</Name>
6 <URL>http://10.2.9.1:99/Department.xml</URL>
7 </MenuItem>
8
9 <MenuItem>
10 <Name>Department2</Name>
11 <URL>http://10.2.9.1:99/Department.xml</URL>
12 </MenuItem>
13
14 <SoftKeyItem>
15 <Name>#</Name>
16 <URL>http://10.2.9.1:99/Department.xml</URL>
17 </SoftKeyItem>
18

```

- For each XML file that you want to add, add the following strings to the file. Each starts on a separate line:

```
<SoftKeyItem>
<Name> #</Name>
<URL> http://10.2.9.1:99/Department.xml</URL>
</SoftKeyItem>
```

```

1 <YealinkIPPhoneMenu>
2 <Title>XiaMen Yealink</Title>
3
4 <MenuItem>
5 <Name>Department1</Name>
6 <URL>http://10.2.9.1:99/Department.xml</URL>
7 </MenuItem>
8
9 <MenuItem>
10 <Name>Department2</Name>
11 <URL>http://10.2.9.1:99/Department.xml</URL>
12 </MenuItem>
13
14 <SoftKeyItem>
15 <Name>#</Name>
16 <URL>http://10.2.9.1:99/Department.xml</URL>
17 </SoftKeyItem>
18

```

- Save the file and place this file to the provisioning server.
- Specify the access URL of the remote phone book (remote_phonebook.data.1.url = http://192.168.1.20/Menu.xml).

During the auto provisioning process, the IP phone connects to the provisioning server “192.168.1.20”, and downloads the remote phone book file “Menu.xml”.

Note Yealink supplies a phonebook generation tool to generate a remote XML phone book. For more information, refer to [Yealink Phonebook Generation Tool User Guide](#).

Incoming/Outgoing Call Lookup allows IP phones to search the entry names from the remote phone book for incoming/outgoing calls. Update Time Interval specifies how often IP phones refresh the local cache of the remote phone book.

Procedure

Remote phone book can be configured using the configuration files or locally.

<p>Configuration File</p>	<p><y000000000xx> .cfg</p>	<p>Specify the access URL and the display name of the remote phone book.</p> <p>Parameters: remote_phonebook.data.X.url remote_phonebook.data.X.name remote_phonebook.display_name</p> <p>Specify whether to query the entry name from the remote phone book for outgoing/incoming calls.</p> <p>Parameter: features.remote_phonebook.enable</p> <p>Specify how often the IP phone refreshes the local cache of the remote phone book.</p> <p>Parameter: features.remote_phonebook.flash_time</p> <p>Specify whether to refresh the local cache of the remote phone book at a time when accessing the remote phone book.</p> <p>Parameter: features.remote_phonebook.enter_update_enable</p>
<p>Local</p>	<p>Web User Interface</p>	<p>Specify the access URL and the display name of the remote phone book.</p> <p>Specify whether to query the entry name from the remote phone book for outgoing/incoming calls.</p> <p>Specify how often the IP phone refreshes the local cache of the remote phone book.</p>

		<p>Navigate to: <a href="http://<phoneIPAddress>/servlet?p=contacts-remote&q=load">http://<phoneIPAddress>/servlet?p=contacts-remote&q=load</p>
--	--	---

Details of Configuration Parameters:

Parameters	Permitted Values	Default
<p>remote_phonebook.data.X.url (X ranges from 1 to 5)</p>	<p>URL within 511 characters</p>	<p>Blank</p>
<p>Description: Configures the access URL of the remote phone book.</p> <p>Example: remote_phonebook.data.1.url = http://192.168.1.20/phonebook.xml</p> <p>Web User Interface: Directory->Remote Phone Book->Remote URL</p> <p>Phone User Interface: None</p>		
<p>remote_phonebook.data.X.name (X ranges from 1 to 5)</p>	<p>String within 99 characters</p>	<p>Blank</p>
<p>Description: Configures the display name of the remote phone book item.</p> <p>Example: remote_phonebook.data.1.name = Xmyl</p> <p>Web User Interface: Directory->Remote Phone Book->Display Name</p> <p>Phone User Interface: None</p>		
<p>remote_phonebook.display_name</p>	<p>String within 99 characters</p>	<p>Blank</p>
<p>Description: Configures the display name of the remote phone book.</p> <p>Example: remote_phonebook.display_name = Friends "Friends" will be displayed on the LCD screen at the path Menu->Directory. If it is left blank, Remote Phone Book will be the display name.</p>		

Parameters	Permitted Values	Default
<p>Note: It is not applicable to SIP-T42G/T41P IP phones.</p> <p>Web User Interface: None</p> <p>Phone User Interface: None</p>		
features.remote_phonebook.enable	0 or 1	0
<p>Description: Enables or disables the IP phone to perform a remote phone book search for an incoming or outgoing call and display the matched results on the LCD screen.</p> <p>0-Disabled 1-Enabled</p> <p>Web User Interface: Directory->Remote Phone Book->Incoming/Outgoing Call Lookup</p> <p>Phone User Interface: None</p>		
features.remote_phonebook.flash_time	0, Integer from 3600 to 1296000	21600
<p>Description: Configures how often to refresh the local cache of the remote phone book. If it is set to 3600, the IP phone will refresh the local cache of the remote phone book every 3600 seconds.</p> <p>Note: If it is set to 0, the IP phone will refresh the local cache of the remote phone book aperiodically.</p> <p>Web User Interface: Directory->Remote Phone Book->Update Time Interval(Seconds)</p> <p>Phone User Interface: None</p>		
features.remote_phonebook.enter_update_enable	0 or 1	0
<p>Description: Enables or disables the IP phone to refresh the local cache of the remote phone book at a time when accessing the remote phone book.</p> <p>0-Disabled 1-Enabled</p>		

Parameters	Permitted Values	Default
Web User Interface:		
None		
Phone User Interface:		
None		

To specify access URL of the remote phone book via web user interface:

1. Click on **Directory->Remote Phone Book**.
2. Enter the access URL in the **Remote URL** field.
3. Enter the name in the **Display Name** field.

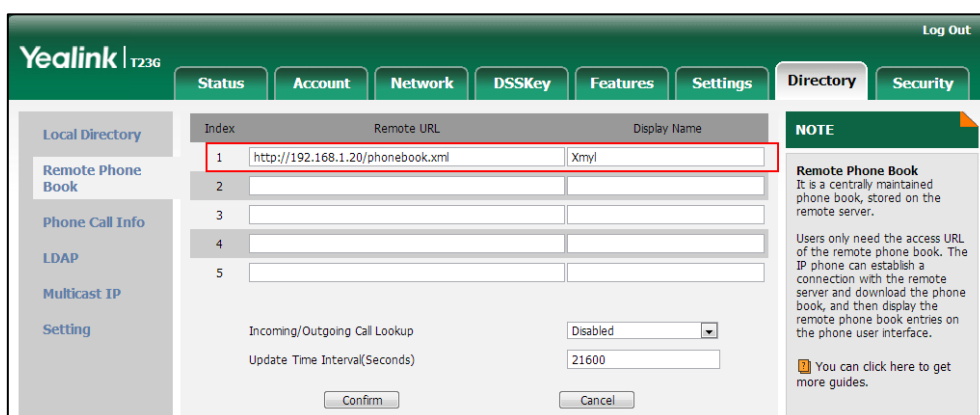

4. Click **Confirm** to accept the change.

To configure incoming/outgoing call lookup and update time interval via web user interface:

1. Click on **Directory->Remote Phone Book**.
2. Select the desired value from the pull-down list of **Incoming/Outgoing Call Lookup**.
3. Enter the desired time in the **Update Time Interval(Seconds)** field.

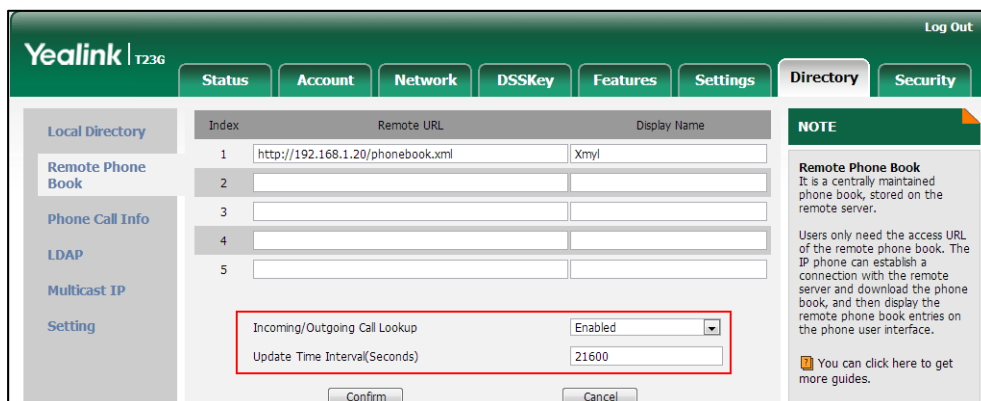

4. Click **Confirm** to accept the change.

LDAP

LDAP (Lightweight Directory Access Protocol) is an application protocol for accessing and maintaining information services for the distributed directory over an IP network. IP phones can be configured to interface with a corporate directory server that supports LDAP version 2 or 3. The following LDAP servers are supported:

- Microsoft Active Directory
- Sun ONE Directory Server
- Open LDAP Directory Server
- Microsoft Active Directory Application Mode (ADAM)

The biggest plus for LDAP is that users can access the central LDAP directory of the corporation using IP phones. Therefore they do not have to maintain the directory locally. Users can search and dial out from the LDAP directory, and save LDAP entries to the local directory. LDAP entries displayed on the IP phone are read only, which cannot be added, edited or deleted by users. When an LDAP server is properly configured, the IP phone can look up entries from the LDAP server in a wide variety of ways. The LDAP server indexes all the data in its entries, and “filters” can be used to select the desired entry or group, and return the desired information.

Configurations on the IP phone limit the amount of the displayed entries when querying from the LDAP server, and decide how attributes are displayed and sorted.

You can set a DSS key to be an LDAP key, and then press the LDAP key to enter the LDAP search screen when the IP phone is idle.

Note

LDAP is not applicable to SIP-T19(P) E2 IP phones.

LDAP Attributes

The following table lists the most common attributes used to configure the LDAP lookup on IP phones.

Abbreviation	Name	Description
gn	givenName	First name
cn	commonName	LDAP attribute is made up from given name joined to surname.
sn	surname	Last name or family name
dn	distinguishedName	Unique identifier for each entry
dc	dc	Domain component
-	company	Company or organization name

Abbreviation	Name	Description
-	telephoneNumber	Office phone number
mobile	mobilephoneNumber	Mobile or cellular phone number
ipPhone	IPphoneNumber	Home phone number

For more information on LDAP, refer to [LDAP Phonebook on Yealink IP Phones](#).

Procedure

LDAP can be configured using the configuration files or locally.

<p>Configuration File</p>	<p><y0000000000xx>.cfg</p>	<p>Configure LDAP.</p> <p>Parameters:</p> <p>ldap.enable ldap.name_filter ldap.number_filter ldap.tls_mode ldap.host ldap.port ldap.base ldap.user ldap.password ldap.max_hits ldap.name_attr ldap.numb_attr ldap.display_name ldap.version ldap.call_in_lookup ldap.call_out_lookup ldap.ldap_sort ldap.incoming_call_special_search.enable</p> <p>Assign an LDAP key.</p> <p>Parameters:</p> <p>linekey.X.type/ programablekey.X.type/ expansion_module.X.key.Y.type linekey.X.label/ programablekey.X.label/ expansion_module.X.key.Y.label</p>
----------------------------------	----------------------------------	--

Local	Web User Interface	<p>Configure LDAP.</p> <p>Navigate to:</p> <p>http://<phoneIPAddress>/servlet ?p=contacts-LDAP&q=load</p> <p>Assign an LDAP key.</p> <p>Navigate to:</p> <p>http://<phoneIPAddress>/servlet ?p=dsskey&q=load&model=0</p>
	Phone User Interface	Assign an LDAP key.

Details of Configuration Parameters:

Parameters	Permitted Values	Default
ldap.enable	0 or 1	0
<p>Description:</p> <p>Enables or disables LDAP feature on the IP phone.</p> <p>0-Disabled</p> <p>1-Enabled</p> <p>Note: It is not applicable to SIP-T19(P) E2 IP phones.</p> <p>Web User Interface:</p> <p>Directory->LDAP->Enable LDAP</p> <p>Phone User Interface:</p> <p>None</p>		
ldap.name_filter	String within 99 characters	Blank
<p>Description:</p> <p>Configures the search criteria for LDAP contact names look up. The "*" symbol in the filter stands for any character. The "%" symbol in the filter stands for the name prefix entered by the user.</p> <p>Example:</p> <p>ldap.name_filter = ((cn=%)(sn=%))</p> <p>When the cn or sn of the LDAP contact starts with the entered prefix, the record will be displayed on the LCD screen.</p> <p>Note: It is not applicable to SIP-T19(P) E2 IP phones.</p> <p>Web User Interface:</p> <p>Directory->LDAP->LDAP Name Filter</p>		

Parameters	Permitted Values	Default
Phone User Interface: None		
ldap.number_filter	String within 99 characters	Blank
Description: Configures the search criteria for LDAP contact numbers look up. The "*" symbol in the filter stands for any number. The "%" symbol in the filter stands for the number prefix entered by the user. Example: ldap.number_filter = ((telephoneNumber=%)(mobile=%)(ipPhone=%)) When the number prefix of the telephoneNumber, mobile or ipPhone of the contact record matches the search criteria, the record will be displayed on the LCD screen. Note: It is not applicable to SIP-T19(P) E2 IP phones. Web User Interface: Directory->LDAP->LDAP Number Filter Phone User Interface: None		
ldap.tls_mode	0, 1 or 2	0
Description: Configures the connection mode between the LDAP server and the IP phone. 0-LDAP —Unencrypted connection between LDAP server and the IP phone (port 389 is used by default). 1-LDAP TLS Start —TLS/SSL connection between LDAP server and the IP phone (port 389 is used by default). 2-LDAPs —TLS/SSL connection between LDAP server and the IP phone (port 636 is used by default). Note: It is not applicable to SIP-T19(P) E2 IP phones. Web User Interface: Directory->LDAP->LDAP TLS Mode Phone User Interface: None		
ldap.host	IP address or domain name	Blank

Parameters	Permitted Values	Default
<p>Description: Configures the IP address or domain name of the LDAP server.</p> <p>Example: ldap.host = 192.168.1.20</p> <p>Note: It is not applicable to SIP-T19(P) E2 IP phones.</p> <p>Web User Interface: Directory->LDAP->Server Address</p> <p>Phone User Interface: None</p>		
ldap.port	Integer from 1 to 65535	389
<p>Description: Configures the port of the LDAP server.</p> <p>Example: ldap.port = 389</p> <p>Note: It is not applicable to SIP-T19(P) E2 IP phones.</p> <p>Web User Interface: Directory->LDAP->Port</p> <p>Phone User Interface: None</p>		
ldap.base	String within 99 characters	Blank
<p>Description: Configures the LDAP search base which corresponds to the location of the LDAP phone book from which the LDAP search request begins. The search base narrows the search scope and decreases directory search time.</p> <p>Example: ldap.base = dc=yealink,dc=cn</p> <p>Note: It is not applicable to SIP-T19(P) E2 IP phones.</p> <p>Web User Interface: Directory->LDAP->Base</p> <p>Phone User Interface: None</p>		

Parameters	Permitted Values	Default
ldap.user	String within 99 characters	Blank
<p>Description: Configures the user name used to login the LDAP server. This parameter can be left blank in case the server allows anonymous to login. Otherwise you will need to provide the user name to login the LDAP server.</p> <p>Example: ldap.user = cn=manager,dc=yealink,dc=cn</p> <p>Note: It is not applicable to SIP-T19(P) E2 IP phones.</p> <p>Web User Interface: Directory->LDAP->Username</p> <p>Phone User Interface: None</p>		
ldap.password	String within 99 characters	Blank
<p>Description: Configures the password to login the LDAP server. This parameter can be left blank in case the server allows anonymous to login. Otherwise you will need to provide the password to login the LDAP server.</p> <p>Example: ldap.password = secret</p> <p>Note: It is not applicable to SIP-T19(P) E2 IP phones.</p> <p>Web User Interface: Directory->LDAP->Password</p> <p>Phone User Interface: None</p>		
ldap.max_hits	Integer from 1 to 32000	50
<p>Description: Configures the maximum number of search results to be returned by the LDAP server. If the value of the "Max.Hits" is blank, the LDAP server will return all searched results. Please note that a very large value of the "Max. Hits" will slow down the LDAP search speed, therefore it should be configured according to the available bandwidth.</p> <p>Example:</p>		

Parameters	Permitted Values	Default
<p>ldap.max_hits = 50</p> <p>Note: It is not applicable to SIP-T19(P) E2 IP phones.</p> <p>Web User Interface: Directory->LDAP->Max Hits (1~32000)</p> <p>Phone User Interface: None</p>		
ldap.name_attr	String within 99 characters	Blank
<p>Description: Configures the name attributes of each record to be returned by the LDAP server. It compresses the search results. You can configure multiple name attributes separated by spaces.</p> <p>Example: ldap.name_attr = cn sn</p> <p>This requires the “cn” and “sn” attributes set for each contact record on the LDAP server.</p> <p>Note: It is not applicable to SIP-T19(P) E2 IP phones.</p> <p>Web User Interface: Directory->LDAP->LDAP Name Attributes</p> <p>Phone User Interface: None</p>		
ldap.numb_attr	String within 99 characters	Blank
<p>Description: Configures the number attributes of each record to be returned by the LDAP server. It compresses the search results. You can configure multiple number attributes separated by spaces.</p> <p>Example: ldap.numb_attr = mobile ipPhone</p> <p>This requires the “mobile” and “ipPhone” attributes set for each contact record on the LDAP server.</p> <p>Note: It is not applicable to SIP-T19(P) E2 IP phones.</p> <p>Web User Interface: Directory->LDAP->LDAP Number Attributes</p> <p>Phone User Interface:</p>		

Parameters	Permitted Values	Default
None		
ldap.display_name	String within 99 characters	Blank
<p>Description: Configures the display name of the contact record displayed on the LCD screen. The value must start with “%” symbol.</p> <p>Example: ldap.display_name = %cn The cn of the contact record is displayed on the LCD screen.</p> <p>Note: It is not applicable to SIP-T19(P) E2 IP phones.</p> <p>Web User Interface: Directory->LDAP->LDAP Display Name</p> <p>Phone User Interface: None</p>		
ldap.version	2 or 3	3
<p>Description: Configures the LDAP protocol version supported by the IP phone. Make sure the protocol value corresponds with the version assigned on the LDAP server.</p> <p>Note: It is not applicable to SIP-T19(P) E2 IP phones.</p> <p>Web User Interface: Directory->LDAP->Protocol</p> <p>Phone User Interface: None</p>		
ldap.call_in_lookup	0 or 1	0
<p>Description: Enables or disables the IP phone to perform an LDAP search when receiving an incoming call.</p> <p>0-Disabled 1-Enabled</p> <p>Note: It is not applicable to SIP-T19(P) E2 IP phones.</p> <p>Web User Interface: Directory->LDAP->LDAP Lookup For Incoming Call</p>		

Parameters	Permitted Values	Default
Phone User Interface: None		
ldap.call_out_lookup	0 or 1	1
Description: Enables or disables the IP phone to perform an LDAP search when placing a call. 0 -Disabled 1 -Enabled Note: It is not applicable to SIP-T19(P) E2 IP phones. Web User Interface: Directory->LDAP->LDAP Lookup For Callout Phone User Interface: None		
ldap.ldap_sort	0 or 1	0
Description: Enables or disables the IP phone to sort the search results in alphabetical order or numerical order. 0 -Disabled 1 -Enabled Note: It is not applicable to SIP-T19(P) E2 IP phones. Web User Interface: Directory->LDAP->LDAP Sorting Results Phone User Interface: None		
ldap.incoming_call_special_search.enable	0 or 1	0
Description: Enables or disables the IP phone to search the telephone numbers starting with "+" symbol and "00" from the LDAP server if the incoming phone number starts with "+" or "00". When completing the LDAP search, the all search results will be displayed on the LCD screen. 0 -Disabled 1 -Enabled For example,		

Parameters	Permitted Values	Default
<p>If the phone receives an incoming call from the phone number 0044123456789, it will search 0044123456789 from the LDAP sever first, if no result found, it will search +44123456789 from the server again. The phone will display all the search results.</p> <p>Note: It works only if the value of the parameter "ldap.call_in_lookup" is set to 1 (Enabled). You may need to set the value of the parameter "ldap.name_filter" to be ((cn=%)(sn=%)(telephoneNumber=%)(mobile=%)) for searching the telephone numbers starting with "+" symbol. It is not applicable to SIP-T19(P) E2 IP phones.</p> <p>Web User Interface: None</p> <p>Phone User Interface: None</p>		

LDAP Key

For more information on how to configure the DSS Key, refer to [Appendix D: Configuring DSS Key](#) on page 751.

Parameters	Permitted Values	Default
linekey.X.type/ programablekey.X.type/ expansion_module.X.key.Y.type	38	Refer to the following content
<p>Description: Configures a DSS key as an LDAP key on the IP phone.</p> <p>The digit 38 stands for the key type LDAP.</p> <p>For line keys: X ranges from 1 to 29 (for SIP-T48G) X ranges from 1 to 27 (for SIP-T46G/T29G) X ranges from 1 to 15 (for SIP-T42G/T41P) X ranges from 1 to 21 (for SIP-T27P) X ranges from 1 to 3 (for SIP-T23P/G) X ranges from 1 to 2 (for SIP-T21(P) E2)</p> <p>For programable keys: X=1-10, 12-14 (for SIP-T48G/T46G) X=1-10, 13 (for SIP-T42G/T41P) X=1-14 (for SIP-T29G/T27P) X=1-10, 14 (for SIP-T23P/T23G/T21(P) E2)</p>		

Parameters	Permitted Values	Default
<p>For ext keys:</p> <p>X ranges from 1 to 6, Y ranges from 1 to 20, 22 to 40 (Ext key 21 cannot be configured).</p> <p>Example:</p> <p>linekey.1.type = 38</p> <p>Default:</p> <p>For SIPT48G IP phones:</p> <p>The default value of the line key 1-16 is 15, and the default value of the line key 17-29 is 0.</p> <p>For SIPT46G/T29G IP phones:</p> <p>The default value of the line key 1-16 is 15, and the default value of the line key 17-27 is 0.</p> <p>For SIPT42G IP phones:</p> <p>The default value of the line key 1-12 is 15, and the default value of the line key 13-15 is 0.</p> <p>For SIPT41P IP phones:</p> <p>The default value of the line key 1-6 is 15, and the default value of the line key 7-15 is 0.</p> <p>For SIPT27P IP phones:</p> <p>The default value of the line key 1-6 is 15, and the default value of the line key 7-21 is 0.</p> <p>For SIPT23P/T23G/T21 (P) E2 IP phones:</p> <p>The default value is 15.</p> <p>For programable keys:</p> <p>For SIPT48G/T46G IP phones:</p> <p>When X=1, the default value is 28 (History).</p> <p>When X=2, the default value is 61 (Directory).</p> <p>When X=3, the default value is 5 (DND).</p> <p>When X=4, the default value is 30 (Menu).</p> <p>When X=5, the default value is 28 (History).</p> <p>When X=6, the default value is 61 (Directory).</p> <p>When X=7, the default value is 0 (NA).</p> <p>When X=8, the default value is 0 (NA).</p> <p>When X=9, the default value is 33 (Status).</p> <p>When X=10, the default value is 0 (NA).</p> <p>When X=12, the default value is 0 (NA).</p>		

Parameters	Permitted Values	Default
<p>When X=13, the default value is 0 (NA).</p> <p>When X=14, the default value is 2 (Forward).</p> <p>For SIP-T42G/T41P IP phones:</p> <p>When X=1, the default value is 28 (History).</p> <p>When X=2, the default value is 61 (Directory).</p> <p>When X=3, the default value is 5 (DND).</p> <p>When X=4, the default value is 30 (Menu).</p> <p>When X=5, the default value is 28 (History).</p> <p>When X=6, the default value is 61 (Directory).</p> <p>When X=7, the default value is 0 (NA).</p> <p>When X=8, the default value is 0 (NA).</p> <p>When X=9, the default value is 33 (Status).</p> <p>When X=10, the default value is 0 (NA).</p> <p>When X=13, the default value is 0 (NA).</p> <p>For SIP-T29G/T27P IP phones:</p> <p>When X=1, the default value is 28 (History).</p> <p>When X=2, the default value is 61 (Directory).</p> <p>When X=3, the default value is 5 (DND).</p> <p>When X=4, the default value is 30 (Menu).</p> <p>When X=5, the default value is 28 (History).</p> <p>When X=6, the default value is 61 (Directory).</p> <p>When X=7, the default value is 0 (NA).</p> <p>When X=8, the default value is 0 (NA).</p> <p>When X=9, the default value is 33 (Status).</p> <p>When X=10, the default value is 0 (NA).</p> <p>When X=11, the default value is 0 (NA).</p> <p>When X=12, the default value is 0 (NA).</p> <p>When X=13, the default value is 0 (NA).</p> <p>When X=14, the default value is 2 (Forward).</p> <p>For SIP-T23P/T23G/T21(P) E2 IP phones:</p> <p>When X=1, the default value is 28 (History).</p> <p>When X=2, the default value is 61 (Directory).</p> <p>When X=3, the default value is 5 (DND).</p> <p>When X=4, the default value is 30 (Menu).</p> <p>When X=5, the default value is 28 (History).</p>		

Parameters	Permitted Values	Default
<p>When X=6, the default value is 61 (Directory). When X=7, the default value is 0 (NA). When X=8, the default value is 0 (NA). When X=9, the default value is 33 (Status). When X=10, the default value is 0 (NA). When X=14, the default value is 2 (Forward). For ext keys: When Y=1, the default value is 37 (Switch). When Y= 2 to 20, 22 to 40, the default value is 0 (NA). Note: It is not applicable to SIP-T19(P) E2 IP phones.</p> <p>Web User Interface: DSSKey->Line Key/ Programable Key->Type</p> <p>Phone User Interface: Menu->Features->DSS Keys->Line Key X->Type</p>		
<p>linekey.X.label/ programablekey.X.label/ expansion_module.X.key.Y.label</p>	<p>String within 99 characters</p>	<p>Blank</p>
<p>Description: (Optional.) Configures the label displayed on the LCD screen for each DSS key. For line keys: X ranges from 1 to 29 (for SIP-T48G) X ranges from 1 to 27 (for SIP-T46G/T29G) X ranges from 1 to 15 (for SIP-T42G/T41P) X ranges from 1 to 21 (for SIP-T27P) X ranges from 1 to 3 (for SIP-T23P/G) X ranges from 1 to 2 (for SIP-T21(P) E2) For programable keys: X ranges from 1 to 4. For ext keys: X ranges from 1 to 6, Y ranges from 1 to 20, 22 to 40 (Ext key 21 cannot be configured). Note: It is not applicable to SIP-T19(P) E2 IP phones.</p> <p>Web User Interface: DSSKey->Line Key/Programable Key->Label</p> <p>Phone User Interface:</p>		

Parameters	Permitted Values	Default
Menu->Features->DSS Keys->Line Key X->Label		

To configure LDAP via web user interface:

1. Click on **Directory->LDAP**.
2. Enter the values in the corresponding fields.
3. Select the desired values from the corresponding pull-down lists.

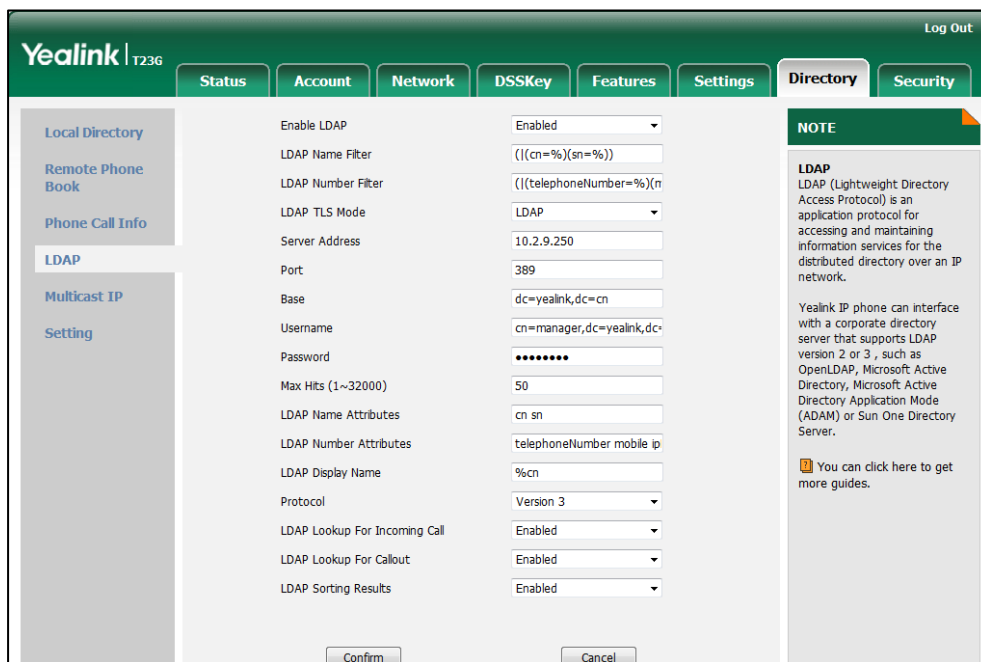

4. Click **Confirm** to accept the change.



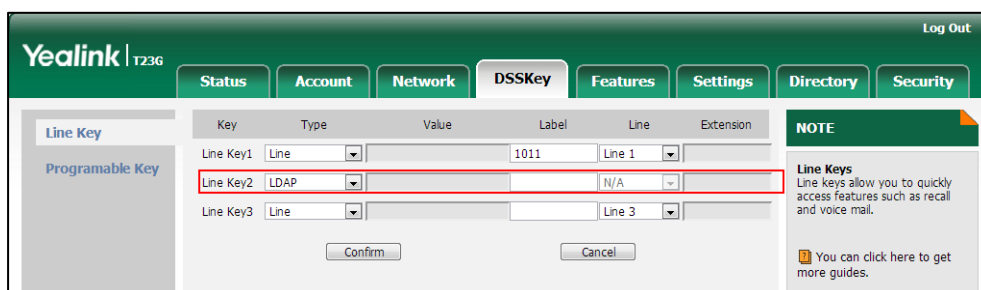

To configure an LDAP key via web user interface:

1. Click on **DSSKey->Line Keys (or Programmable Key)**.
2. In the desired DSS key field, select **LDAP** from the pull-down list of **Type**.
3. (Optional.) Enter the string that will appear on the LCD screen in the **Label** field.



4. Click **Confirm** to accept the change.

To configure an LDAP key via phone user interface:

1. Press **Menu**->**Features**->**DSS Keys**.
2. Select the desired DSS key.
3. Press  or  , or the **Switch** soft key to select **Key Event** from the **Type** field.
4. Press  or  , or the **Switch** soft key to select **LDAP** from the **Key Type** field.
5. (Optional.) Enter the string that will appear on the LCD screen in the **Label** field.
6. Press the **Save** soft key to accept the change.

Busy Lamp Field (BLF)

BLF is used to monitor a specific user for status changes on IP phones. For example, you can configure a BLF key on a supervisor's phone to monitor the IP phone user status (busy or idle). When the monitored user places a call, a busy indicator on the supervisor's phone indicates that the user's phone is in use.

When the monitored user is idle, the supervisor can press the BLF key to dial out the phone number. When the monitored user receives an incoming call, the supervisor can press the BLF key to pick up the call directly. When the monitored user is in a call, the supervisor can press the BLF key to interrupt and set up a conference call.

Note

BLF is not applicable to SIP-T19(P) E2 IP phones.

BLF Subscription

IP phones support BLF using a SUBSCRIBE/NOTIFY mechanism as specified in [RFC 3265](#). This feature depends on support from a SIP server.

When the IP phone is configured to monitor a specific user, it sends a SUBSCRIBE message to the server. A NOTIFY message which includes XML in the message body is sent to the IP phone to inform the current state of monitored user. Once status of the monitored user is changed from idle to busy or vice versa, the IP phone is notified from the server with a NOTIFY message. You can manually configure the period of the BLF subscription.

Example of a SUBSCRIBE message:

```
SUBSCRIBE sip:1011@10.3.20.2:5060 SIP/2.0
Via: SIP/2.0/UDP 10.3.20.1:5060;branch=z9hG4bK2940676338
From: "1010" <sip:1010@10.3.5.199:5060>;tag=2493044525
To: <sip:1011@10.3.5.199:5060>;tag=2527548726
Call-ID: 0_3538292381@10.3.20.1
CSeq: 2 SUBSCRIBE
Contact: <sip:1010@10.3.20.1:5060>
Accept: application/dialog-info+xml
```

```

Max-Forwards: 70
User-Agent: Yealink SIP-T23G 44.80.0.20
Expires: 30
Event: dialog
Content-Length: 0

```

Example of a NOTIFY message (<state>confirmed</state> shows the call has been established):

```

NOTIFY sip:1010@10.3.20.1:5060 SIP/2.0
Via: SIP/2.0/UDP 10.3.20.2:5060;branch=z9hG4bK276311022
From: <sip:1011@10.3.5.199:5060>;tag=3436332841
To: "1010" <sip:1010@10.3.5.199:5060>;tag=3098567568
Call-ID: 0_4117916748@10.3.20.1
CSeq: 4 NOTIFY
Contact: <sip:1011@10.3.20.2:5060>
Content-Type: application/dialog-info+xml
Max-Forwards: 70
User-Agent: Yealink SIP-T27P 45.80.0.20
Subscription-State: active;expires=17
Event: dialog
Content-Length: 534

<?xml version="1.0"?>
<dialog-info xmlns="urn:ietf:params:xml:ns:dialog-info" version="3" state="partial"
entity="sip:1011@10.3.5.199:5060">
<dialog id="74" call-id="0_2561109579@10.3.20.1" local-tag="2778958897" remote-tag="1132018898"
direction="recipient">
<state>confirmed</state>
<local>
<identity>sip:1011@10.3.5.199:5060</identity>
<target uri="sip:1011@10.3.5.199:5060"/>
</local>
<remote>
<identity>sip:1010@10.3.5.199:5060</identity>
<target uri="sip:1010@10.3.5.199:5060"/>
</remote>
</dialog>
</dialog-info>

```

Visual Alert and Audio Alert for BLF Pickup

Visual and audio alert for BLF pickup allow the supervisor's phone to play an alert tone and display a visual prompt (e.g., "6001 <-6002", 6001 is the monitored extension which receives an incoming call from 6002) when the monitored user receives an incoming call. In addition to the BLF key, visual alert for BLF pickup feature enables the supervisor to

pick up the monitored user's incoming call by pressing the DPickup soft key. The directed call pickup code must be configured in advance. For more information on how to configure the directed call pickup code for the Pickup soft key, refer to [Directed Call Pickup](#) on page 315.

BLF LED Mode

BLF LED Mode provides four kinds of definition for the BLF/BLF List key LED status. As there is no hard line key on SIP-T48G IP phones, BLF LED mode configuration is only applicable to SIP-T46G/T42G/T41P/T29G/T27P/T23P/T23G/T21(P) E2 IP phones. BLF LED mode is also applicable to the expansion module EXP40 connected to SIP-T48G/T46G IP phones, EXP38/EXP39 connected to SIP-T29G and SIP-T27P IP phones. The following table lists the LED statuses of the BLF key when BLF LED Mode is set to 0, 1, 2 or 3 respectively. The default value of BLF LED mode is 0.

BLF LED mode feature is also applicable to BLF list key. For more information on BLF List key, refer to [BLF List](#) on page 433.

Line key/Expansion Module Key LED (configured as a BLF key or a BLF List key and BLF LED Mode is set to 0)

LED Status	Description
Solid green	The monitored user is idle.
Fast flashing red (200ms)	The monitored user receives an incoming call.
Solid red	The monitored user is dialing. The monitored user is talking. The monitored user's conversation is placed on hold (This LED status requires server support).
Slow flashing red (1s)	The call is parked against the monitored user's phone number.
Off	The monitored user does not exist.

Line Key/Expansion Module Key LED (configured as a BLF key or a BLF List key and BLF LED Mode is set to 1)

LED Status	Description
Fast flashing red (200ms)	The monitored user receives an incoming call.
Solid red	The monitored user is dialing. The monitored user is talking. The monitored user's conversation is placed on hold (This LED status requires server support).
Slow flashing red (1s)	The call is parked against the monitored user's phone number.
Off	The monitored user is idle. The monitored user does not exist.

Line Key/Expansion Module Key LED (configured as a BLF key a BLF List key and BLF LED Mode is set to 2)

LED Status	Description
Fast flashing red (200ms)	The monitored user receives an incoming call.
Solid red	The monitored user is dialing. The monitored user is talking. The monitored user's conversation is placed on hold (This LED status requires server support).
Slow flashing red (1s)	The call is parked against the monitored user's phone number.
Off	The monitored user is idle. The monitored user does not exist.

Line Key/Expansion Module Key LED (configured as a BLF key a BLF List key and BLF LED Mode is set to 3)

LED Status	Description
Fast flashing green (200ms)	The monitored user receives an incoming call.
Solid red	The monitored user is dialing. The monitored user is talking. The monitored user's conversation is placed on hold (This LED status requires server support).
Slow flashing red (1s)	The call is parked against the monitored user's phone number.
Off	The monitored user is idle. The monitored user does not exist.

Procedure

BLF can be configured using the configuration files or locally.

Configuration File	y0000000000xx.cfg	<p>Specify whether to use visual alert and audio alert for BLF pickup.</p> <p>Parameters:</p> <p>features.pickup.blf_visual_enable features.pickup.blf_audio_enable</p> <p>Assign a BLF key.</p> <p>Parameters:</p> <p>linekey.X.type/ expansion_module.X.key.Y.type linekey.X.line/</p>
---------------------------	-------------------	--

		<p>expansion_module.X.key.Y.line linekey.X.value/ expansion_module.X.key.Y.value linekey.X.pickup_value/ expansion_module.X.key.Y.pickup_value linekey.X.label/ expansion_module.X.key.Y.label Configure BLF LED mode. Parameter: features.blf_led_mode</p>
	<p><MAC>.cfg</p>	<p>Configure the period of the BLF subscription. Parameter: account.X.blf.subscribe_period Configure the event of the BLF subscription. Parameter: account.X.blf.subscribe_event Configure whether to handle NOTIFY messages out of the BLF dialog. Parameter: account.X.out_dialog_blf_enable</p>
<p>Local</p>	<p>Web User Interface</p>	<p>Assign a BLF key. Navigate to: <a href="http://<phoneIPAddress>/servlet?p=dsskey&q=load&model=0">http://<phoneIPAddress>/servlet?p=dsskey&q=load&model=0 Specify whether to use visual alert and audio alert for BLF pickup. Navigate to: <a href="http://<phoneIPAddress>/servlet?p=features-callpickup&q=load">http://<phoneIPAddress>/servlet?p=features-callpickup&q=load Configure BLF LED mode. Navigate to: <a href="http://<phoneIPAddress>/servlet?p=features-general&q=load">http://<phoneIPAddress>/servlet?p=features-general&q=load Configure the period of the BLF subscription. Configure whether to handle NOTIFY messages out of the BLF dialog.</p>

		<p>Navigate to: <a href="http://<phoneIPAddress>/servlet?p=account-adv&q=load&acc=0">http://<phoneIPAddress>/servlet?p=account-adv&q=load&acc=0</p>
	Phone User Interface	Assign a BLF key.

Details of Configuration Parameters:

Parameters	Permitted Values	Default
features.pickup.blf_visual_enable	0 or 1	0
<p>Description: Enables or disables the IP phone to display a visual alert when the monitored user receives an incoming call. 0-Disabled 1-Enabled</p> <p>Note: It is not applicable to SIP-T19(P) E2 IP phones.</p> <p>Web User Interface: Features->Call Pickup->Visual Alert for BLF Pickup</p> <p>Phone User Interface: None</p>		
features.pickup.blf_audio_enable	0 or 1	0
<p>Description: Enables or disables the IP phone to play an audio alert when the monitored user receives an incoming call. 0-Disabled 1-Enabled</p> <p>Note: It is not applicable to SIP-T19(P) E2 IP phones.</p> <p>Web User Interface: Features->Call Pickup->Audio Alert for BLF Pickup</p> <p>Phone User Interface: None</p>		
features.blf_led_mode	0, 1, 2 or 3	0

Parameters	Permitted Values	Default
<p>Description: Configures BLF LED mode and provides four kinds of definition for the BLF/BLF List key LED status.</p> <p>Note: It is not applicable to SIP-T19(P) E2 IP phones.</p> <p>Web User Interface: Features->General Information->BLF LED Mode</p> <p>Phone User Interface: None</p>		
account.X.blf.subscribe_period	Integer from 30 to 2147483647	1800
<p>Description: Configures the period (in seconds) of the BLF subscription for account X. X ranges from 1 to 16 (for SIP-T48G/T46G/T29G) X ranges from 1 to 12 (for SIP-T42G) X ranges from 1 to 6 (for SIP-T41P/T27P) X ranges from 1 to 3 (for SIP-T23P/G) X ranges from 1 to 2 (for SIP-T21(P) E2) The IP phone is able to successfully refresh the SUBSCRIBE before expiration of the SUBSCRIBE dialog.</p> <p>Note: It is not applicable to SIP-T19(P) E2 IP phones.</p> <p>Web User Interface: Account->Advanced->Subscribe Period(Seconds)</p> <p>Phone User Interface: None</p>		
account.X.blf.subscribe_event	0 or 1	0
<p>Description: Configures the event of the BLF subscription for account X. 0-dialog 1-presence X ranges from 1 to 16 (for SIP-T48G/T46G/T29G) X ranges from 1 to 12 (for SIP-T42G) X ranges from 1 to 6 (for SIP-T41P/T27P)</p>		

Parameters	Permitted Values	Default
<p>X ranges from 1 to 3 (for SIP-T23P/G) X ranges from 1 to 2 (for SIP-T21(P) E2)</p> <p>Note: It is not applicable to SIP-T19(P) E2 IP phones.</p> <p>Web User Interface: None</p> <p>Phone User Interface: None</p>		
account.X.out_dialog_blf_enable	0 or 1	0
<p>Description: Enables or disables the IP phone to handle NOTIFY messages out of the BLF dialog for account X.</p> <p>0-Disabled 1-Enabled</p> <p>X ranges from 1 to 16 (for SIP-T48G/T46G/T29G) X ranges from 1 to 12 (for SIP-T42G) X ranges from 1 to 6 (for SIP-T41P/T27P) X ranges from 1 to 3 (for SIP-T23P/G) X ranges from 1 to 2 (for SIP-T21(P) E2)</p> <p>Note: It is not applicable to SIP-T19(P) E2 IP phones.</p> <p>Web User Interface: Account->Advanced->Out Dialog BLF</p> <p>Phone User Interface: None</p>		

BLF Key

For more information on how to configure the DSS Key, refer to [Appendix D: Configuring DSS Key](#) on page 751.

Parameters	Permitted Values	Default
linekey.X.type/ expansion_module.X.key.Y.type	16	Refer to the following content

Parameters	Permitted Values	Default
<p>Description: Configures a DSS key as a BLF key on the IP phone. The digit 16 stands for the key type BLF. For line keys: X ranges from 1 to 29 (for SIP-T48G) X ranges from 1 to 27 (for SIP-T46G/T29G) X ranges from 1 to 15 (for SIP-T42G/T41P) X ranges from 1 to 21 (for SIP-T27P) X ranges from 1 to 3 (for SIP-T23P/G) X ranges from 1 to 2 (for SIP-T21(P) E2) For ext keys: X ranges from 1 to 6, Y ranges from 1 to 20, 22 to 40 (Ext key 21 cannot be configured).</p> <p>Example: linekey.1.type = 16</p> <p>Default: For line keys: For SIP-T48G IP phones: The default value of the line key 1-16 is 15, and the default value of the line key 17-29 is 0. For SIP-T46G/T29G IP phones: The default value of the line key 1-16 is 15, and the default value of the line key 17-27 is 0. For SIP-T42G IP phones: The default value of the line key 1-12 is 15, and the default value of the line key 13-15 is 0. For SIP-T41P IP phones: The default value of the line key 1-6 is 15, and the default value of the line key 7-15 is 0. For SIP-T27P IP phones: The default value of the line key 1-6 is 15, and the default value of the line key 7-21 is 0. For SIP-T23P/T23G/T21(P) E2 IP phones: The default value is 15. For ext keys:</p>		

Parameters	Permitted Values	Default
<p>When Y=1, the default value is 37 (Switch). When Y= 2 to 20, 22 to 40, the default value is 0 (NA).</p> <p>Note: It is not applicable to SIP-T19(P) E2 IP phones.</p> <p>Web User Interface: DSSKey->Line Key->Type</p> <p>Phone User Interface: Menu->Features->DSS Keys->Line Key X->Type</p>		
<p>linekey.X.line/ expansion_module.X.key.Y.line</p>	<p>Refer to the following content</p>	<p>1-16 correspond to the lines 1-16</p>
<p>Description: Configures the desired line to apply the BLF key. For line keys: X ranges from 1 to 29 (for SIP-T48G) X ranges from 1 to 27 (for SIP-T46G/T29G) X ranges from 1 to 15 (for SIP-T42G/T41P) X ranges from 1 to 21 (for SIP-T27P) X ranges from 1 to 3 (for SIP-T23P/G) X ranges from 1 to 2 (for SIP-T21(P) E2) For ext keys: X ranges from 1 to 6, Y ranges from 1 to 20, 22 to 40 (Ext key 21 cannot be configured).</p> <p>Permitted Values: 1 to 16 (for SIP-T48G/T46G/T29G) 1 to 12 (for SIP-T42G) 1 to 6 (for SIP-T41P/T27P) 1 to 3 (for SIP-T23P/G) 1 to 2 (for SIP-T21(P) E2)</p> <p>1-Line 1 2-Line 2 ... 16-Line 16</p> <p>Example: linekey.1.line = 1</p> <p>Note: It is not applicable to SIP-T19(P) E2 IP phones.</p>		

Parameters	Permitted Values	Default
<p>Web User Interface: DSSKey->Line Key->Line</p> <p>Phone User Interface: Menu->Features->DSS Keys->Line Key X->Account ID</p>		
linekey.X.value/ expansion_module.X.key.Y.value	String within 99 characters	Blank
<p>Description: Configures the number of the monitored user. For line keys: X ranges from 1 to 29 (for SIP-T48G) X ranges from 1 to 27 (for SIP-T46G/T29G) X ranges from 1 to 15 (for SIP-T42G/T41P) X ranges from 1 to 21 (for SIP-T27P) X ranges from 1 to 3 (for SIP-T23P/G) X ranges from 1 to 2 (for SIP-T21(P) E2) For ext keys: X ranges from 1 to 6, Y ranges from 1 to 20, 22 to 40 (Ext key 21 cannot be configured).</p> <p>Example: linekey.1.value = 1008</p> <p>Note: It is not applicable to SIP-T19(P) E2 IP phones.</p> <p>Web User Interface: DSSKey->Line Key->Value</p> <p>Phone User Interface: Menu->Features->DSS Keys->Line Key X->Value</p>		
linekey.X.pickup_value/ expansion_module.X.key.Y.pickup_value	String within 256 characters	Blank
<p>Description: Configures the pickup code for BLF feature. This parameter only applies to BLF feature. For line keys: X ranges from 1 to 29 (for SIP-T48G)</p>		

Parameters	Permitted Values	Default
<p>X ranges from 1 to 27 (for SIP-T46G/T29G) X ranges from 1 to 15 (for SIP-T42G/T41P) X ranges from 1 to 21 (for SIP-T27P) X ranges from 1 to 3 (for SIP-T23P/G) X ranges from 1 to 2 (for SIP-T21(P) E2)</p> <p>For ext keys: X ranges from 1 to 6, Y ranges from 1 to 20, 22 to 40 (Ext key 21 cannot be configured).</p> <p>Example: line.1.pickup_value = *88</p> <p>Note: It is not applicable to SIP-T19(P) E2 IP phones.</p> <p>Web User Interface: DSSKey->Line Key->Extension</p> <p>Phone User Interface: Menu->Features->DSS Keys->Line Key X->Extension</p>		
linekey.X.label/ expansion_module.X.key.Y.label	String within 99 characters	Blank
<p>Description: (Optional.) Configures the label displayed on the LCD screen for each DSS key.</p> <p>For line keys: X ranges from 1 to 29 (for SIP-T48G) X ranges from 1 to 27 (for SIP-T46G/T29G) X ranges from 1 to 15 (for SIP-T42G/T41P) X ranges from 1 to 21 (for SIP-T27P) X ranges from 1 to 3 (for SIP-T23P/G) X ranges from 1 to 2 (for SIP-T21(P) E2)</p> <p>For ext keys: X ranges from 1 to 6, Y ranges from 1 to 20, 22 to 40 (Ext key 21 cannot be configured).</p> <p>Note: It is not applicable to SIP-T19(P) E2 IP phones.</p> <p>Web User Interface: DSSKey->Line Key->Label</p> <p>Phone User Interface: Menu->Features->DSS Keys->Line Key X->Label</p>		

To configure a BLF key via web user interface:

1. Click on **DSSKey->Line Key**.
2. In the desired DSS key field, select **BLF** from the pull-down list of **Type**.
3. Enter the phone number or extension you want to monitor in the **Value** field.
4. Select the desired line from the pull-down list of **Line**.
5. (Optional.) Enter the string that will appear on the LCD screen in the **Label** field.
6. (Optional.) Enter the directed call pickup code in the **Extension** field.

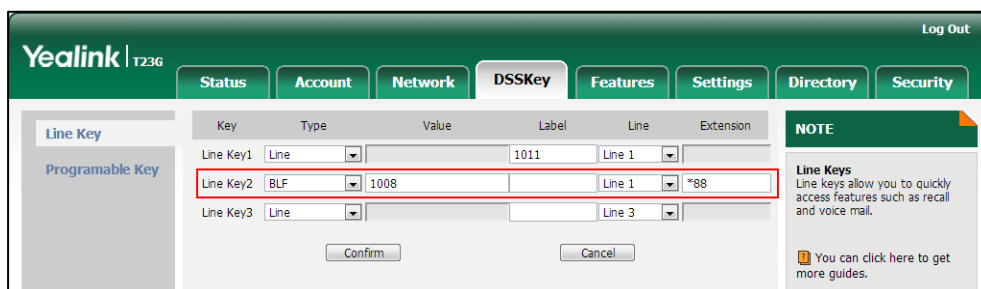

7. Click **Confirm** to accept the change.

To configure visual alert and audio alert for BLF pickup via web user interface:

1. Click on **Features->Call Pickup**.
2. Select the desired value from the pull-down list of **Visual Alert for BLF Pickup**.
3. Select the desired value from the pull-down list of **Audio Alert for BLF Pickup**.

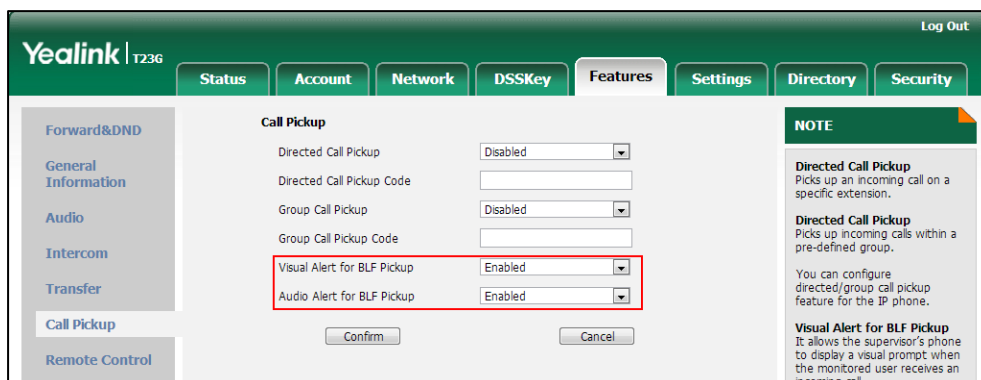

4. Click **Confirm** to accept the change.

To configure BLF LED mode via web user interface:

1. Click on **Features->General Information**.

2. Select the desired value from the pull-down list of **BLF LED Mode**.

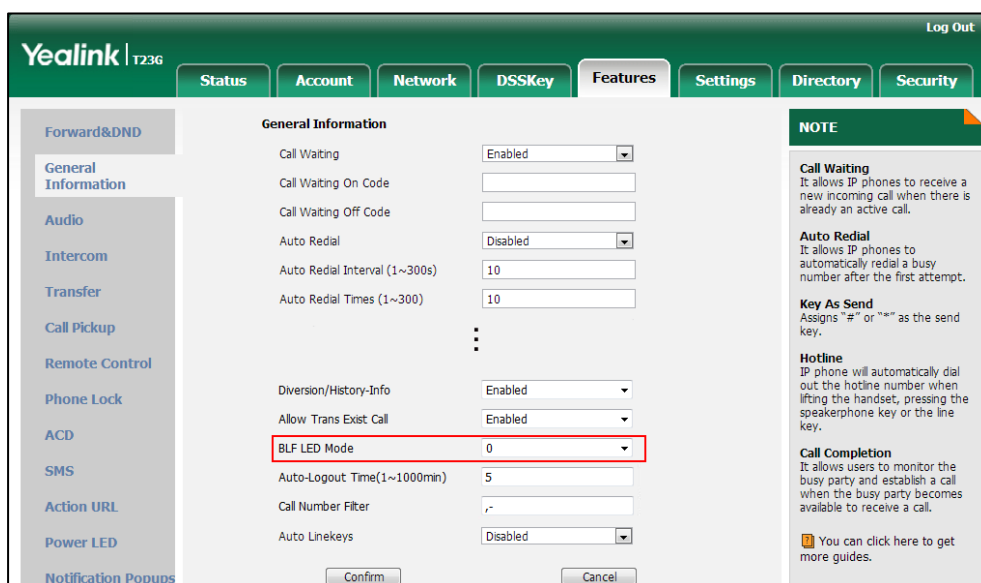

3. Click **Confirm** to accept the change.

To configure BLF subscription via web user interface:

1. Click on **Account->Advanced**.
2. Select the desired account from the pull-down list of **Account**.
3. Enter the desired period of BLF subscription in the **Subscribe Period(Seconds)** field.

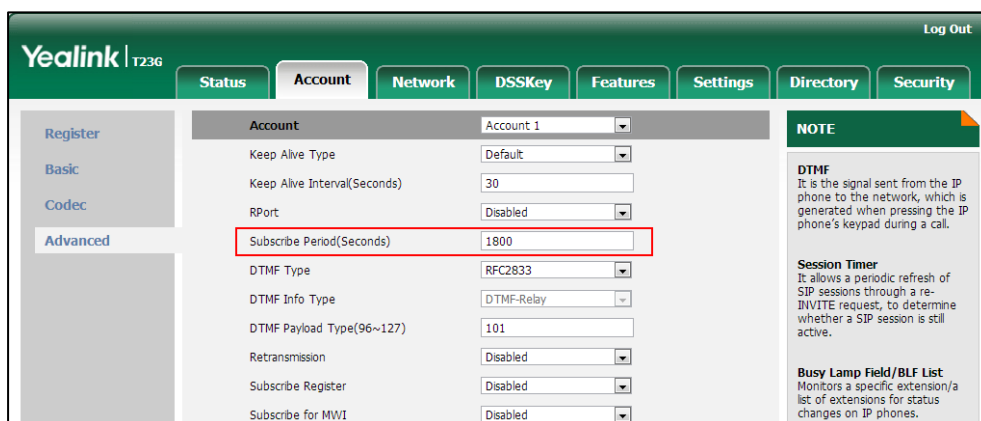

4. Click **Confirm** to accept the change.

To configure a BLF key via phone user interface:

1. Press **Menu->Features->DSS Keys**.
2. Select the desired DSS key.
3. Press **◀** or **▶**, or the **Switch** soft key to select **BLF** from the **Type** field.
4. Press **◀** or **▶**, or the **Switch** soft key to select the desired line from the **Account ID** field.

5. (Optional.) Enter the string that will appear on the LCD screen in the **Label** field.
6. Enter the phone number or extension you want to monitor in the **Value** field.
7. (Optional.) Enter the directed call pickup code in the **Extension** field.
8. Press the **Save** soft key to accept the change.

BLF List

Busy Lamp Field (BLF) List allows a list of specific extensions to be monitored for status changes. It enables the monitoring phone to subscribe to a list of users, and receive notifications of the status of monitored users. Different indicators on the monitoring phone show the status of monitored users. The monitoring user can also be notified about calls being parked/no longer parked against any monitored user. IP phones support BLF list using a SUBSCRIBE/NOTIFY mechanism as specified in [RFC 3265](#). This feature depends on support from a SIP server.

Note BLF list is not applicable to SIP-T19(P) E2 IP phones.

Procedure

BLF List can be configured using the configuration files or locally.

Configuration File	y0000000000xx.cfg	<p>Configure BLF List.</p> <p>Parameters:</p> <p>account.X.blf.blf_list_uri</p> <p>account.X.blf_list_code</p> <p>account.X.blf_list_barge_in_code</p> <p>account.X.blf_list_retrieve_call_parked_code</p> <p>Specify whether to automatically configure the BLF list keys.</p> <p>Parameter:</p> <p>phone_setting.auto_blf_list_enable</p> <p>Configure the order of BLF list keys assigned automatically.</p> <p>Parameter:</p> <p>phone_setting.blf_list_sequence_type</p> <p>Assign a BLF List key.</p> <p>Parameters:</p> <p>linekey.X.type/ expansion_module.X.key.Y.type</p>
---------------------------	-------------------	---

		linekey.X.line/ expansion_module.X.key.Y.line
Local	Web User Interface	Configure BLF List. http://<phoneIPAddress>/servlet?p=account-adv&q=load&acc=0 Assign a BLF List key. Navigate to: http://<phoneIPAddress>/servlet?p=dskey&q=load&model=0
	Phone User Interface	Assign a BLF List key.

Details of Configuration Parameters:

Parameters	Permitted Values	Default
account.X.blf.blf_list_uri	String within 256 characters	Blank
<p>Description: Configures the BLF List URI to monitor a list of users for account X. X ranges from 1 to 16 (for SIP-T48G/T46G/T29G) X ranges from 1 to 12 (for SIP-T42G) X ranges from 1 to 6 (for SIP-T41P/T27P) X ranges from 1 to 3 (for SIP-T23P/G) X ranges from 1 to 2 (for SIP-T21(P) E2) Note: It is not applicable to SIP-T19(P) E2 IP phones. Example: account.1.blf.blf_list_uri = 4609@pbx.yealink.com Phone User Interface: None</p>		
account.X.blf_list_code	String within 32 characters	Blank
<p>Description: Configures the feature access code for directed call pickup for account X. X ranges from 1 to 16 (for SIP-T48G/T46G/T29G) X ranges from 1 to 12 (for SIP-T42G) X ranges from 1 to 6 (for SIP-T41P/T27P) X ranges from 1 to 3 (for SIP-T23P/G)</p>		

Parameters	Permitted Values	Default
<p>X ranges from 1 to 2 (for SIP-T21(P) E2)</p> <p>Note: It is not applicable to SIP-T19(P) E2 IP phones.</p> <p>Example:</p> <p>account.1.blf_list_code = *97</p> <p>Web User Interface:</p> <p>Account->Advanced->BLF List Pickup Code</p> <p>Phone User Interface:</p> <p>None</p>		
account.X.blf_list_barge_in_code	String within 32 characters	Blank
<p>Description:</p> <p>Configures the feature access code for directed call pickup with barge-in for account X.</p> <p>X ranges from 1 to 16 (for SIP-T48G/T46G/T29G)</p> <p>X ranges from 1 to 12 (for SIP-T42G)</p> <p>X ranges from 1 to 6 (for SIP-T41P/T27P)</p> <p>X ranges from 1 to 3 (for SIP-T23P/G)</p> <p>X ranges from 1 to 2 (for SIP-T21(P) E2)</p> <p>Note: It is not applicable to SIP-T19(P) E2 IP phones.</p> <p>Example:</p> <p>account.1.blf_list_barge_in_code = *33</p> <p>Web User Interface:</p> <p>Account->Advanced->BLF List Barge In Code</p> <p>Phone User Interface:</p> <p>None</p>		
account.X.blf_list_retrieve_call_parked_code	String within 32 characters	Blank
<p>Description:</p> <p>Configures the feature access code for the call park retrieve for account X.</p> <p>X ranges from 1 to 16 (for SIP-T48G/T46G/T29G)</p> <p>X ranges from 1 to 12 (for SIP-T42G)</p> <p>X ranges from 1 to 6 (for SIP-T41P/T27P)</p> <p>X ranges from 1 to 3 (for SIP-T23P/G)</p> <p>X ranges from 1 to 2 (for SIP-T21(P) E2)</p>		

Parameters	Permitted Values	Default
<p>Note: It is not applicable to SIP-T19(P) E2 IP phones.</p> <p>Example: account.1.blf_list_retrieve_call_parked_code = *88</p> <p>Web User Interface: Account->Advanced->BLF List Retrieve Call Parked Code</p> <p>Phone User Interface: None</p>		
phone_setting.auto_blf_list_enable	0 or 1	1
<p>Description: Enables or disables the IP phone to automatically configure the BLF list keys.</p> <p>0-Disabled 1-Enabled</p> <p>Note: It is not applicable to SIP-T19(P) E2 IP phones.</p> <p>Web User Interface: None</p> <p>Phone User Interface: None</p>		
phone_setting.blf_list_sequence_type	0 or 1	0
<p>Description: Configures the order of BLF list keys assigned automatically.</p> <p>0-Line Key->Ext Key 1-Ext Key->Line Key</p> <p>Note: It works only if the value of the parameter "phone_setting.auto_blf_list_enable" is set to 1 (Enabled). It is only applicable to SIP-T48G/T46G/T29G/T27P IP phones.</p> <p>Web User Interface: None</p> <p>Phone User Interface: None</p>		

BLF List Key

For more information on how to configure the DSS Key, refer to [Appendix D: Configuring DSS Key](#) on page 751.

Parameters	Permitted Values	Default
linekey.X.type/ expansion_module.X.key.Y.type	39	Refer to the following content
<p>Description: Configures a DSS key as a BLF List key on the IP phone. The digit 39 stands for the key type BLF List. For line keys: X ranges from 1 to 29 (for SIP-T48G) X ranges from 1 to 27 (for SIP-T46G/T29G) X ranges from 1 to 15 (for SIP-T42G/T41P) X ranges from 1 to 21 (for SIP-T27P) X ranges from 1 to 3 (for SIP-T23P/G) X ranges from 1 to 2 (for SIP-T21(P) E2) For ext keys: X ranges from 1 to 6, Y ranges from 1 to 20, 22 to 40 (Ext key 21 cannot be configured). Example: linekey.1.type = 39 Default: For SIP-T48G IP phones: The default value of the line key 1-16 is 15, and the default value of the line key 17-29 is 0. For SIP-T46G/T29G IP phones: The default value of the line key 1-16 is 15, and the default value of the line key 17-27 is 0. For SIP-T42G IP phones: The default value of the line key 1-12 is 15, and the default value of the line key 13-15 is 0. For SIP-T41P IP phones: The default value of the line key 1-6 is 15, and the default value of the line key 7-15 is 0. For SIP-T27P IP phones: The default value of the line key 1-6 is 15, and the default value of the line key 7-21</p>		

Parameters	Permitted Values	Default
<p>is 0.</p> <p>For SIP-T23P/T23G/T21(P) E2 IP phones:</p> <p>The default value is 15.</p> <p>For ext keys:</p> <p>When Y=1, the default value is 37 (Switch).</p> <p>When Y= 2 to 20, 22 to 40, the default value is 0 (NA).</p> <p>Note: It is not applicable to SIP-T19(P) E2 IP phones.</p> <p>Web User Interface:</p> <p>DSSKey->Line Key->Type</p> <p>Phone User Interface:</p> <p>Menu->Features->DSS Keys->Line Key X->Type</p>		
linekey.X.line/ expansion_module.X.key.Y.line	Refer to the following content	1-16 correspond to the lines 1-16
<p>Description:</p> <p>Configures the desired line to apply the BLF List key.</p> <p>For line keys:</p> <p>X ranges from 1 to 29 (for SIP-T48G).</p> <p>X ranges from 1 to 27 (for SIP-T46G/T29G).</p> <p>X ranges from 1 to 15 (for SIP-T42G/T41P).</p> <p>X ranges from 1 to 21 (for SIP-T27P).</p> <p>X ranges from 1 to 3 (for SIP-T23P/G)</p> <p>X ranges from 1 to 2 (for SIP-T21(P) E2)</p> <p>For ext keys:</p> <p>X ranges from 1 to 6, Y ranges from 1 to 20, 22 to 40 (Ext key 21 cannot be configured).</p> <p>Permitted Values:</p> <p>1 to 16 (for SIP-T48G/T46G/T29G)</p> <p>1 to 12 (for SIP-T42G)</p> <p>1 to 6 (for SIP-T41P/T27P)</p> <p>1 to 3 (for SIP-T23P/G)</p> <p>1 to 2 (for SIP-T21(P) E2)</p> <p>1-Line 1</p> <p>2-Line 2</p> <p>...</p> <p>16-Line 16</p>		

Parameters	Permitted Values	Default
<p>Example: linekey.1.line = 1</p> <p>Note: It is not applicable to SIP-T19(P) E2 IP phones.</p> <p>Web User Interface: DSSKey->Line Key->Line</p> <p>Phone User Interface: Menu->Features->DSS Keys->Line Key X->Account ID</p>		

To configure the BLF List settings via web user interface:

1. Click on **Account->Advanced**.
2. Select the account (e.g., account 1) from the pull-down list of **Account**.
3. Enter the BLF List URI in the **BLF List URI** field.
4. (Optional.) Enter the directed pickup code in the **BLF List Pickup Code** field.
5. (Optional.) Enter the barge-in code in the **BLF List Barge In Code** field.
6. (Optional.) Enter the retrieve call parked code in the **BLF List Retrieve Call Parked Code** field.

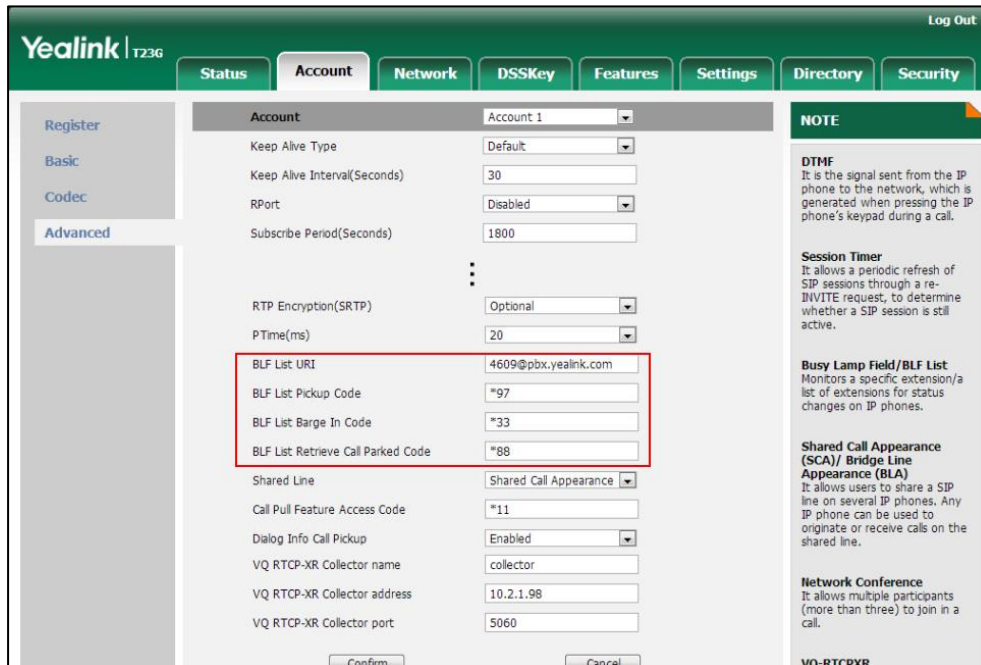

7. Click **Confirm** to accept the change.

To configure BLF List keys manually via web user interface:

1. Click on **DSSKey->Line Key (or Programmable Key)**.
2. In the desired DSS key field, select **BLF List** from the pull-down list of **Type**.

3. Repeat step 2-3, configure more BLF list keys.

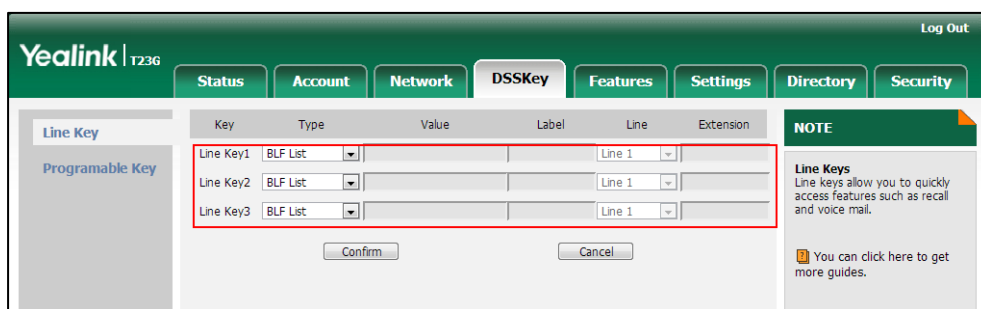

4. Click **Confirm** to accept the change.

Hide Features Access Code

Hide Features Access Code feature enables the IP phone to display the feature name instead of the dialed feature access code automatically. For example, the dialed call park code will be replaced by the identifier “Call Park” when you park an active call. The hide feature access codes feature is applicable to the following features:

- Voice Mail
- Pick up
- Group Pick up
- Barge In (not applicable to SIP-T19(P) E2 IP phones)
- Retrieve (not applicable to SIP-T19(P) E2 IP phones)
- Call Park (not applicable to SIP-T19(P) E2 IP phones)
- Group Park (not applicable to SIP-T19(P) E2 IP phones)

Procedure

The hide feature access codes feature can be configured using the configuration files or locally.

Configuration File	<y0000000000xx>.cfg	Configure the hide feature access codes feature. Parameters: features.hide_feature_access_codes.enable
Local	Web User Interface	Configure the hide feature access codes feature. Navigate to: http://<phoneIPAddress>/servlet?p=features-general&q=load

Details of Configuration Parameters:

Parameters	Permitted Values	Default
features.hide_feature_access_codes.enable	0 or 1	0
<p>Description: Enables or disables the IP phone to display feature name instead of the feature access code when dialing and in talk.</p> <p>0-Disabled 1-Enabled</p> <p>Web User Interface: Features->General Information->Hide Feature Access Codes</p> <p>Phone User Interface: None</p>		

To enable hide feature access codes feature via web user interface:

1. Click on **Features-> General Information**.
2. Select **Enabled** from the pull-down list of **Hide Feature Access Codes**.

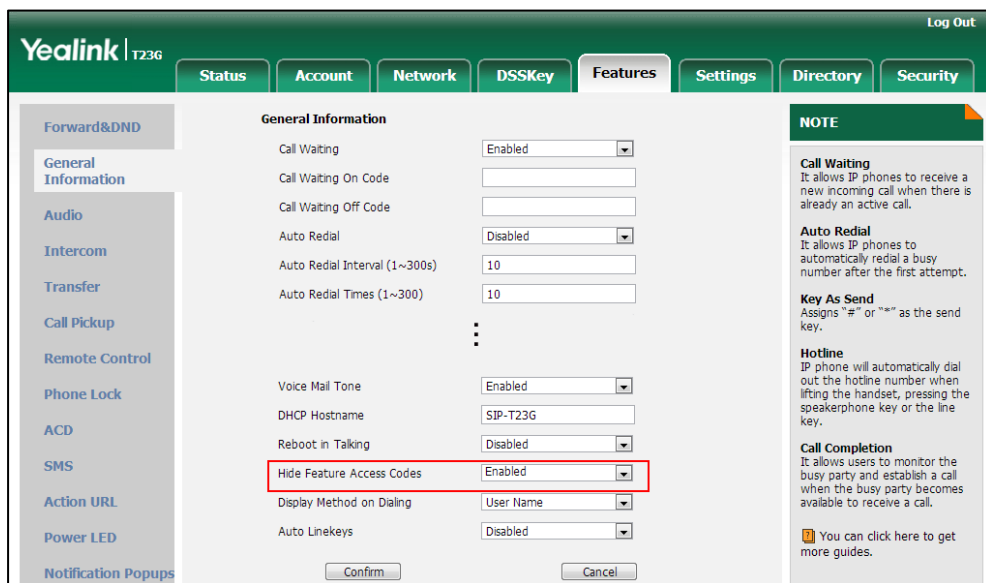

3. Click **Confirm** to accept the change.

Automatic Call Distribution (ACD)

ACD enables organizations to manage a large number of phone calls on an individual basis. ACD enables the use of IP phones in a call-center role by automatically distributing incoming calls to available users, or agents. ACD depends on support from

a SIP server. ACD is disabled on the IP phone by default. You need to enable it on a per-line basis before logging into the ACD system.

After the IP phone user logs into the ACD system, the server monitors the IP phone status and then decides whether to assign an incoming call to the user's IP phone. When the IP phone status is changed to unavailable, the server stops distributing calls to the IP phone. The IP phone will remain in the unavailable status until the user manually changes the IP phone status or the ACD auto available timer (if configured) expires. How long the IP phone remains unavailable is configurable by the auto available timer. When the timer expires, the IP phone status is automatically changed to available. ACD auto available timer feature depends on support from a SIP server.

You need to configure an ACD key for the user to log into the ACD system. The ACD key on the IP phone indicates the ACD status.

Procedure

ACD can be configured using the configuration files or locally.

Configuration File	<MAC>.cfg	Configure ACD feature on a per-line basis. Parameters: account.X.acd.enable account.X.acd.available account.X.subscribe_acd_expires
	<y0000000000xx>.cfg	Configure ACD auto available. Parameters: acd.auto_available acd.auto_available_timer Assign an ACD key. Parameters: linekey.X.type/ expansion_module.X.key.Y.type linekey.X.label/ expansion_module.X.key.Y.label
Local	Web User Interface	Configure ACD auto available. Navigate to: http://<phoneIPAddress>/servlet ?p=features-acd&q=load Assign an ACD key. Navigate to: http://<phoneIPAddress>/servlet ?p=dsskey&model=1&q=load&li

		nepage=1
	Phone User Interface	Assign an ACD key.

Details of Configuration Parameters:

Parameters	Permitted Values	Default
account.X.acd.enable	0 or 1	0
<p>Description: Enables or disables ACD feature for account X. 0-Disabled 1-Enabled X ranges from 1 to 16 (for SIP-T48G/T46G/T29G) X ranges from 1 to 12 (for SIP-T42G) X ranges from 1 to 6 (for SIP-T41P/T27P) X ranges from 1 to 3 (for SIP-T23P/G) X ranges from 1 to 2 (for SIP-T21(P) E2) X is equal to 1 (for SIP-T19(P) E2)</p> <p>Web User Interface: None</p> <p>Phone User Interface: None</p>		
account.X.acd.available	0 or 1	0
<p>Description: Enables or disables the IP phone to display the available and unavailable soft keys for account X after the IP phone logs into the ACD system. 0-Disabled 1-Enabled X ranges from 1 to 16 (for SIP-T48G/T46G/T29G) X ranges from 1 to 12 (for SIP-T42G) X ranges from 1 to 6 (for SIP-T41P/T27P) X ranges from 1 to 3 (for SIP-T23P/G) X ranges from 1 to 2 (for SIP-T21(P) E2) X is equal to 1 (for SIP-T19(P) E2)</p> <p>Web User Interface:</p>		

Parameters	Permitted Values	Default
None Phone User Interface: None		
account.X.subscribe_acd_expires	Integer from 120 to 3600	3600
Description: Configures the period (in seconds) of ACD subscription for account X. X ranges from 1 to 16 (for SIP-T48G/T46G/T29G) X ranges from 1 to 12 (for SIP-T42G) X ranges from 1 to 6 (for SIP-T41P/T27P) X ranges from 1 to 3 (for SIP-T23P/G) X ranges from 1 to 2 (for SIP-T21(P) E2) X is equal to 1 (for SIP-T19(P) E2) Web User Interface: Account->Advanced->ACD Subscribe Period(120~3600s) Phone User Interface: None		
acd.auto_available	0 or 1	0
Description: Enables or disables the IP phone to automatically change the status of the ACD agent to available after the designated time. 0-Disabled 1-Enabled Web User Interface: Features->ACD->ACD Auto Available Phone User Interface: None		
acd.auto_available_timer	Integer from 0 to 120	60
Description: Configures the interval (in seconds) for the status of the ACD agent to be automatically changed to available. Web User Interface:		

Parameters	Permitted Values	Default
Features->ACD->ACD Auto Available Timer (0~120s)		
Phone User Interface:		
None		

ACD Key

For more information on how to configure the DSS Key, refer to [Appendix D: Configuring DSS Key](#) on page 751.

Details of Configuration Parameters:

Parameters	Permitted Values	Default
linekey.X.type/ expansion_module.X.key.Y.type	42	Refer to the following content
<p>Description:</p> <p>Configures a DSS key to be an ACD key on the IP phone.</p> <p>The digit 42 stands for the key type ACD.</p> <p>For line keys:</p> <p>X ranges from 1 to 29 (for SIP-T48G)</p> <p>X ranges from 1 to 27 (for SIP-T46G/T29G)</p> <p>X ranges from 1 to 15 (for SIP-T42G/T41P)</p> <p>X ranges from 1 to 21 (for SIP-T27P)</p> <p>X ranges from 1 to 3 (for SIP-T23P/G)</p> <p>X ranges from 1 to 2 (for SIP-T21(P) E2)</p> <p>For ext keys:</p> <p>X ranges from 1 to 6, Y ranges from 1 to 20, 22 to 40 (Ext key 21 cannot be configured).</p> <p>Example:</p> <p>linekey.2.type = 42</p> <p>Default:</p> <p>For SIP-T48G IP phones:</p> <p>The default value of the line key 1-16 is 15, and the default value of the line key 17-29 is 0.</p> <p>For SIP-T46G/T29G IP phones:</p> <p>The default value of the line key 1-16 is 15, and the default value of the line key 17-27 is 0.</p>		

Parameters	Permitted Values	Default
<p>For SIP-T42G IP phones: The default value of the line key 1-12 is 15, and the default value of the line key 13-15 is 0.</p> <p>For SIP-T41P IP phones: The default value of the line key 1-6 is 15, and the default value of the line key 7-15 is 0.</p> <p>For SIP-T27P IP phones: The default value of the line key 1-6 is 15, and the default value of the line key 7-21 is 0.</p> <p>For SIP-T23P/T23G/T21(P) E2 IP phones: The default value is 15.</p> <p>For ext keys: When Y=1, the default value is 37 (Switch). When Y= 2 to 20, 22 to 40, the default value is 0 (NA).</p> <p>Note: It is not applicable to SIP-T19(P) E2 IP phones.</p> <p>Web User Interface: DSSKey->Line Key->Type</p> <p>Phone User Interface: Menu->Features->DSS Keys->Line Key X->Type</p>		
linekey.X.label/ expansion_module.X.key.Y.label	String within 99 characters	Blank
<p>Description: (Optional.) Configures the label displayed on the LCD screen for each DSS key.</p> <p>For line keys: X ranges from 1 to 29 (for SIP-T48G) X ranges from 1 to 27 (for SIP-T46G/T29G) X ranges from 1 to 15 (for SIP-T42G/T41P) X ranges from 1 to 21 (for SIP-T27P) X ranges from 1 to 3 (for SIP-T23P/G) X ranges from 1 to 2 (for SIP-T21(P) E2)</p> <p>For ext keys: X ranges from 1 to 6, Y ranges from 1 to 20, 22 to 40 (Ext key 21 cannot be configured).</p> <p>Note: It is not applicable to SIP-T19(P) E2 IP phones.</p> <p>Web User Interface:</p>		

Parameters	Permitted Values	Default
DSSKey->Line Key->Label		
Phone User Interface:		
Menu->Features->DSS Keys->Line Key X->Label		

To configure an ACD key via web user interface:

1. Click on **DSSKey->Line Key**.
2. In the desired DSS key field, select **ACD** from the pull-down list of **Type**.
3. (Optional.) Enter the string that will appear on the LCD screen in the **Label** field.

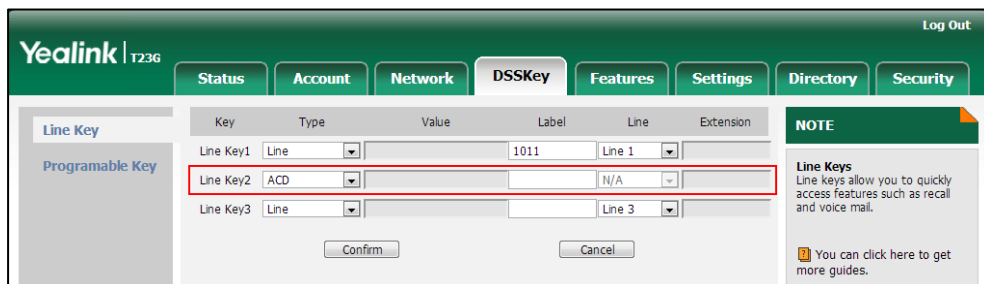

4. Click **Confirm** to accept the change.

To configure the ACD auto available timer feature via web user interface:

1. Click on **Features->ACD**.
2. Select the desired value from the pull-down list of **ACD Auto Available**.
3. Enter the desired timer in the **ACD Auto Available Timer(0~120s)** field.

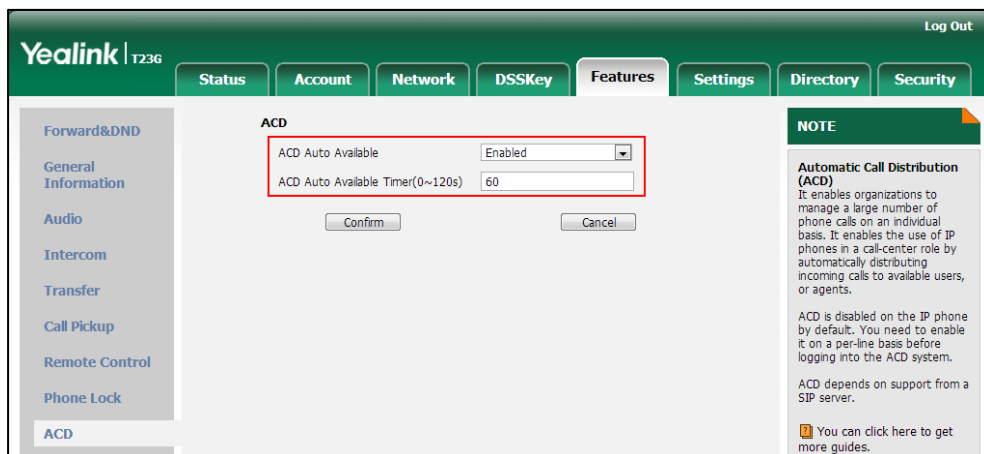

4. Click **Confirm** to accept the change.

To configure the ACD subscribe period via web user interface:

1. Click on **Account->Advanced**.

2. Enter the desired timer in the **ACD Subscribe Period** field.

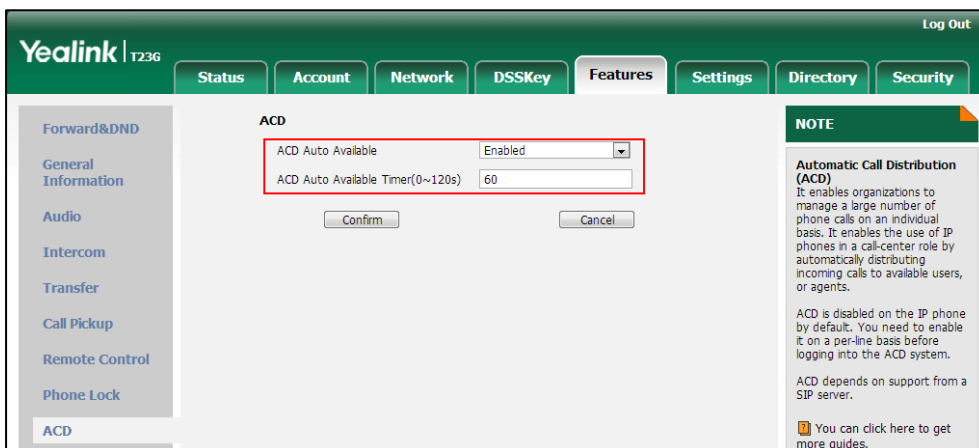

3. Click **Confirm** to accept the change.

To configure an ACD key via phone user interface:

1. Press **Menu->Features->DSS Keys**.
2. Select the desired DSS key.
3. Press **◀** or **▶**, or the **Switch** soft key to select **ACD** from the **Type** field.
4. (Optional.) Enter the string that will appear on the LCD screen in the **Label** field.
5. Press the **Save** soft key to accept the change.

Shared Call Appearance (SCA)

SCA allows users to share an extension which can be registered on two or more IP phones at the same time. For more information on how to register accounts, refer to [Account Registration](#) on page 112.

Any IP phone can be used to originate or receive calls on the shared line. An incoming call can be presented to multiple phones simultaneously. The incoming call can be answered on any IP phone but not all. A call that is active on one IP phone will be presented visually to other IP phones that share the call appearance.

IP phones support SCA using a SUBSCRIBE/NOTIFY mechanism as specified in [RFC 3265](#). The events used are:

- “call-info” for call appearance state notification
- “line-seize” for the IP phone to ask to seize the line

SCA supports the IP phones barging in an active call. In addition, SCA has the call pull capability. Call pull feature allows users to retrieve an existing call from another shared phone that is in active or public hold status.

If the call is placed on public hold, the held call is available for any shared party to retrieve. If the call is placed on private hold, the held call is only available for the hold party to retrieve. You need to configure either the private hold soft key or a private hold

key before you place the call on private hold.

Procedure

SCA can be configured using the configuration files or locally.

Configuration File	<MAC>.cfg	<p>Configure the registration line type.</p> <p>Parameters:</p> <p>account.X.shared_line</p> <p>Configure the call pull feature access code.</p> <p>Parameters:</p> <p>account.X.shared_line_callpull_code</p>
	<y0000000000xx>.cfg	<p>Configure the private hold soft key.</p> <p>Parameters:</p> <p>phone_setting.custom_softkey_enable</p> <p>custom_softkey_talking.url</p> <p>Assign a private hold key.</p> <p>Parameters:</p> <p>linekey.X.type/ expansion_module.X.key.Y.type linekey.X.label/ expansion_module.X.key.Y.label</p>
Local	Web User Interface	<p>Configure the registration line type.</p> <p>Configure the call pull feature access code.</p> <p>Configure the number of DSS keys to be assigned automatically.</p> <p>Navigate to:</p> <p>http://<phoneIPAddress>/servlet?p=account-adv&q=load&acc=0</p> <p>Configure auto linekeys.</p> <p>Navigate to:</p> <p>http://<phoneIPAddress>/servlet</p>

		<p>?p=features-general&q=load</p> <p>Configure the private hold soft key.</p> <p>Configure the private hold soft key.</p> <p>Navigate to:</p> <p>http://<phoneIPAddress>/servlet ?p=settings-softkey&q=load</p> <p>Assign a private hold key.</p> <p>Navigate to:</p> <p>http://<phoneIPAddress>/servlet ?p=dsskey&model=1&q=load&li nepage=1</p>
	Phone User Interface	Assign a private hold key.

Details of Configuration Parameters:

Parameters	Permitted Values	Default
account.X.shared_line	0, 1 or 3	0
<p>Description:</p> <p>Configures the registration line type.</p> <p>0-Disabled</p> <p>1-Shared Call Appearance</p> <p>3-Draft BLA</p> <p>X ranges from 1 to 16 (for SIP-T48G/T46G/T29G)</p> <p>X ranges from 1 to 12 (for SIP-T42G)</p> <p>X ranges from 1 to 6 (for SIP-T41P/T27P)</p> <p>X ranges from 1 to 3 (for SIP-T23P/G)</p> <p>X ranges from 1 to 2 (for SIP-T21(P) E2)</p> <p>X is equal to 1 (for SIP-T19(P) E2)</p> <p>Web User Interface:</p> <p>Account->Advanced->Shared Line</p> <p>Phone User Interface:</p> <p>None</p>		
account.X.shared_line_callpull_code	String within 32 characters	Blank

Parameters	Permitted Values	Default
<p>Description: Configures the call pull feature access code to retrieve an existing call from another shared phone that is in active or public hold status for account X. X ranges from 1 to 16 (for SIP-T48G/T46G/T29G) X ranges from 1 to 12 (for SIP-T42G) X ranges from 1 to 6 (for SIP-T41P/T27P) X ranges from 1 to 3 (for SIP-T23P/G) X ranges from 1 to 2 (for SIP-T21(P) E2) X is equal to 1 (for SIP-T19(P) E2)</p> <p>Note: It works only if the value of the parameter "account.X.shared_line" is set to 1 (Share Call Appearance).</p> <p>Web User Interface: Account->Advanced->Call Pull Feature Access Code</p> <p>Phone User Interface: None</p>		
account.X.number_of_linekey	String within 32 characters	1
<p>Description: Configures the number of DSS keys to be assigned with Line type automatically from the first unused one (unused one means the DSS key is configured as N/A or Line). If a DSS key is used, the IP phone will skip to the next unused DSS key. The order of DSS key assigned automatically is Line Key->Ext Key. X ranges from 1 to 16 (for SIP-T48G/T46G/T29G) X ranges from 1 to 12 (for SIP-T42G) X ranges from 1 to 6 (for SIP-T41P/T27P) X ranges from 1 to 3 (for SIP-T23P/G) X ranges from 1 to 2 (for SIP-T21(P) E2) X is equal to 1 (for SIP-T19(P) E2)</p> <p>Example: account.1.number_of_linekey = 2</p> <p>Note: It works only if the value of the parameter "features.auto_linekeys.enable" is set to 1 (Enabled). It is not applicable to SIP-T19(P) E2 IP phones.</p> <p>Web User Interface: Account->Advanced->Number of line key</p> <p>Phone User Interface:</p>		

Parameters	Permitted Values	Default
None		
features.auto_linekeys.enable	0 or 1	0
<p>Description: Enables or disables the DSS keys to be assigned with Line type automatically. 0-Disabled 1-Enabled</p> <p>Note: The number of the DSS keys is determined by the value of the parameter "account.X.number_of_linekey". It is not applicable to SIP-T19(P) E2 IP phones.</p> <p>Web User Interface: Features->General Information->Auto Linekeys</p> <p>Phone User Interface: None</p>		

Private Hold Soft Key

Configuring the private hold soft key may affect the softkey layout in the Talking state. For more information, refer to [Softkey Layout](#) on page 167.

Details of Configuration Parameters:

Parameters	Permitted Values	Default
phone_setting.custom_softkey_enable	0 or 1	0
<p>Description: Enables or disables custom soft keys layout feature. 0-Disabled 1-Enabled</p> <p>Web User Interface: Settings->Softkey Layout->Custom Softkey</p> <p>Phone User Interface: None</p>		
custom_softkey_talking.url	URL within 511 characters	Blank

Parameters	Permitted Values	Default
<p>Description: Configures the access URL of the custom file for the soft key presented on the LCD screen when in the Talking state.</p> <p>Example: custom_softkey_talking.url = http://192.168.1.20/XMLfiles/Talking.xml</p> <p>During the auto provisioning process, the IP phone connects to the provisioning server "192.168.1.20", and downloads the Talking state file from the "XMLfiles" directory.</p> <p>Web User Interface: None</p> <p>Phone User Interface: None</p>		

Private Hold Key

For more information on how to configure the DSS Key, refer to [Appendix D: Configuring DSS Key](#) on page 751.

Details of Configuration Parameters:

Parameters	Permitted Values	Default
linekey.X.type/ expansion_module.X.key.Y.type	20	Refer to the following content
<p>Description: Configures a DSS key to be a private hold key on the IP phone. The digit 20 stands for the key type Private Hold.</p> <p>For line keys: X ranges from 1 to 29 (for SIP-T48G) X ranges from 1 to 27 (for SIP-T46G/T29G) X ranges from 1 to 15 (for SIP-T42G/T41P) X ranges from 1 to 21 (for SIP-T27P) X ranges from 1 to 3 (for SIP-T23P/G) X ranges from 1 to 2 (for SIP-T21(P) E2)</p> <p>For ext keys: X ranges from 1 to 6, Y ranges from 1 to 20, 22 to 40 (Ext key 21 cannot be configured).</p>		

Parameters	Permitted Values	Default
<p>Example: linekey.2.type = 20</p> <p>Default:</p> <p>For SIP-T48G IP phones: The default value of the line key 1-16 is 15, and the default value of the line key 17-29 is 0.</p> <p>For SIP-T46G/T29G IP phones: The default value of the line key 1-16 is 15, and the default value of the line key 17-27 is 0.</p> <p>For SIP-T42G IP phones: The default value of the line key 1-12 is 15, and the default value of the line key 13-15 is 0.</p> <p>For SIP-T41P IP phones: The default value of the line key 1-6 is 15, and the default value of the line key 7-15 is 0.</p> <p>For SIP-T27P IP phones: The default value of the line key 1-6 is 15, and the default value of the line key 7-21 is 0.</p> <p>For SIP-T23P/T23G/T21(P) E2 IP phones: The default value is 15. For ext keys: When Y=1, the default value is 37 (Switch). When Y= 2 to 20, 22 to 40, the default value is 0 (NA).</p> <p>Note: It is not applicable to SIP-T19(P) E2 IP phones.</p> <p>Web User Interface: DSSKey->Line Key->Type</p> <p>Phone User Interface: Menu->Features->DSS Keys->Line Key X->Type</p>		
linekey.X.label/ expansion_module.X.key.Y.label	String within 99 characters	Blank
<p>Description: (Optional.) Configures the label displayed on the LCD screen for each DSS key. For line keys: X ranges from 1 to 29 (for SIP-T48G) X ranges from 1 to 27 (for SIP-T46G/T29G)</p>		

Parameters	Permitted Values	Default
X ranges from 1 to 15 (for SIP-T42G/T41P)		
X ranges from 1 to 21 (for SIP-T27P)		
X ranges from 1 to 3 (for SIP-T23P/G)		
X ranges from 1 to 2 (for SIP-T21(P) E2)		
For ext keys:		
X ranges from 1 to 6, Y ranges from 1 to 20, 22 to 40 (Ext key 21 cannot be configured).		
Note: It is not applicable to SIP-T19(P) E2 IP phones.		
Web User Interface:		
DSSKey->Line Key->Label		
Phone User Interface:		
Menu->Features->DSS Keys->Line Key X->Label		

To configure auto linekeys feature via web user interface:

1. Click on **Features->General Information**.
2. Select **Enabled** from the pull-down list of **Auto Linekeys**.

If **Auto LineKeys** is enabled, you can automatically assign multiple DSS keys with Line type for a registered shared line on the phone.

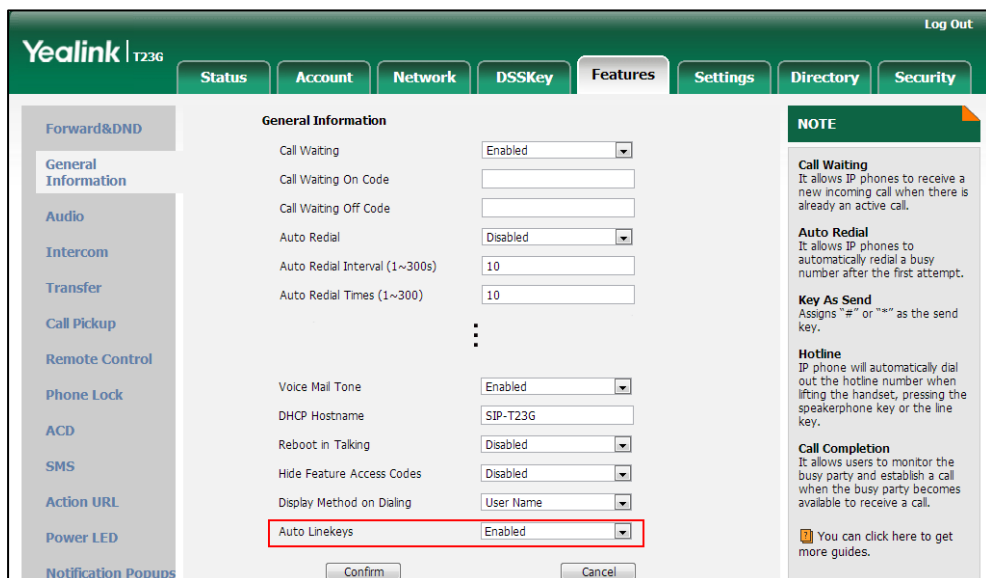

3. Click **Confirm** to accept the change.

To configure the shared line settings on the primary phone via web user interface:

1. Register the primary account (e.g., 4609).

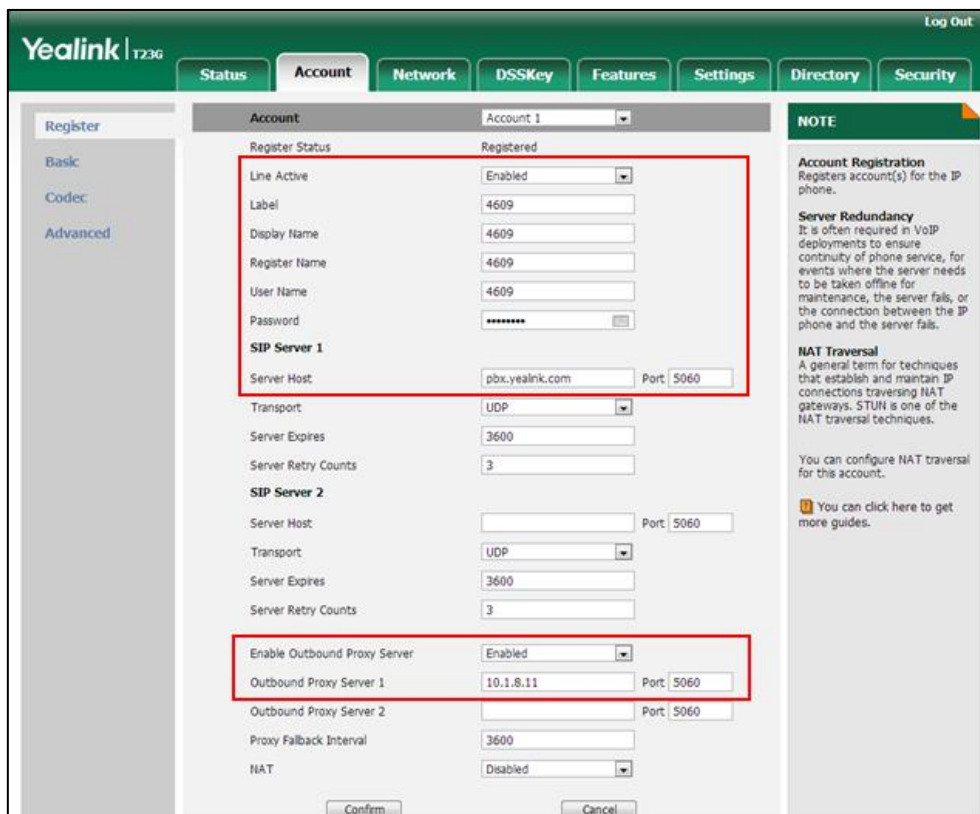

2. Click on **Advanced**, select **Shared Call Appearance** from the pull-down list of **Shared Line**.
3. Enter the desired number in the **Number of line key** field.
This field appears only if **Auto Linekeys** is enabled.

The default value is 1. In this example, the value is set to 2.

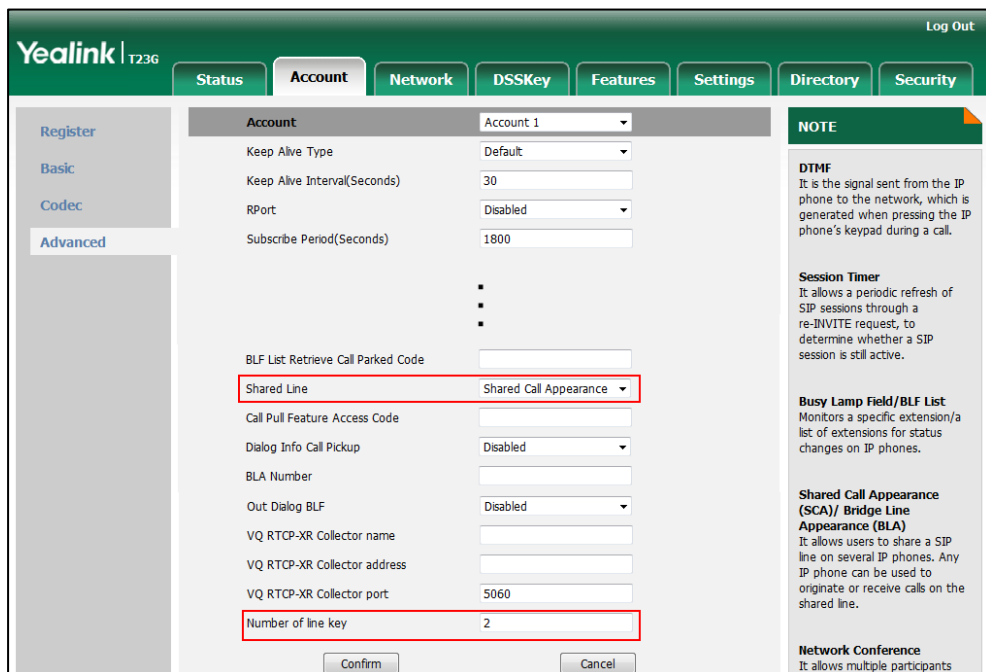

4. Click **Confirm** to accept the change.

To configure the shared line settings on alternate phone via web user interface:

1. Register the alternate account (e.g., 4609_1).
(Enter the primary account 4609 in the **Register Name** field.)

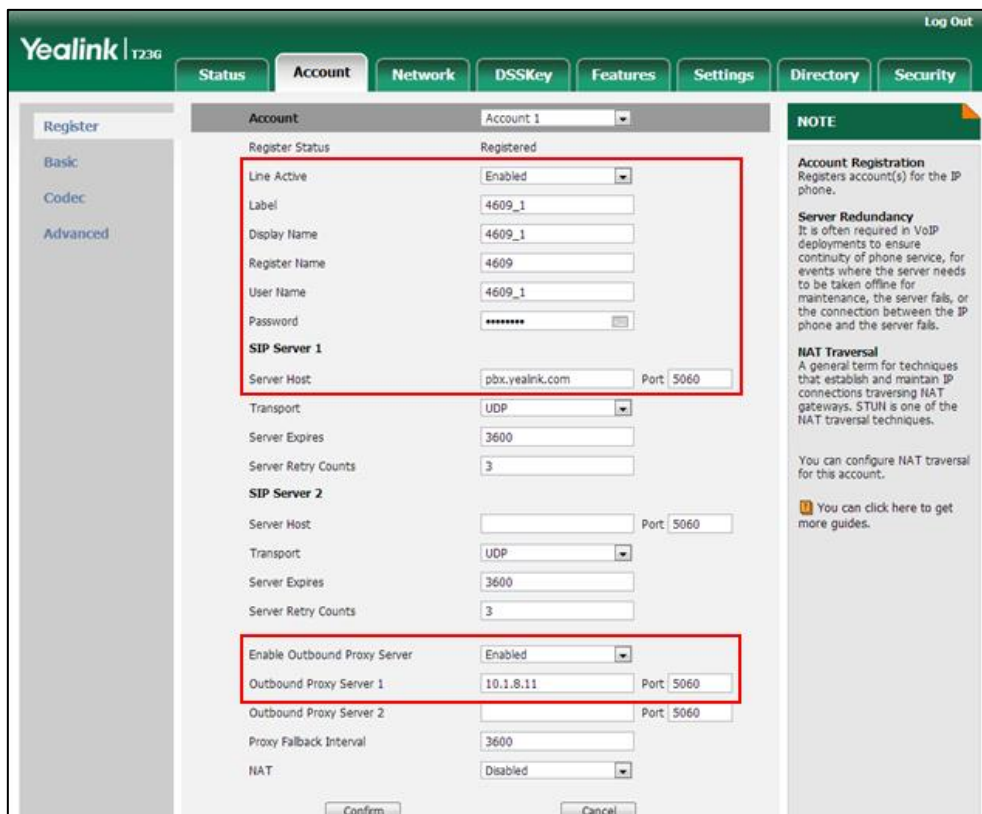

2. Click on **Advanced**, select **Shared Call Appearance** from the pull-down list of **Shared Line**.
3. Enter the desired number in the **Number of line key** field.
This field appears only if **Auto Linekeys** is enabled.
The default value is 1. In this example, the value is set to 2.

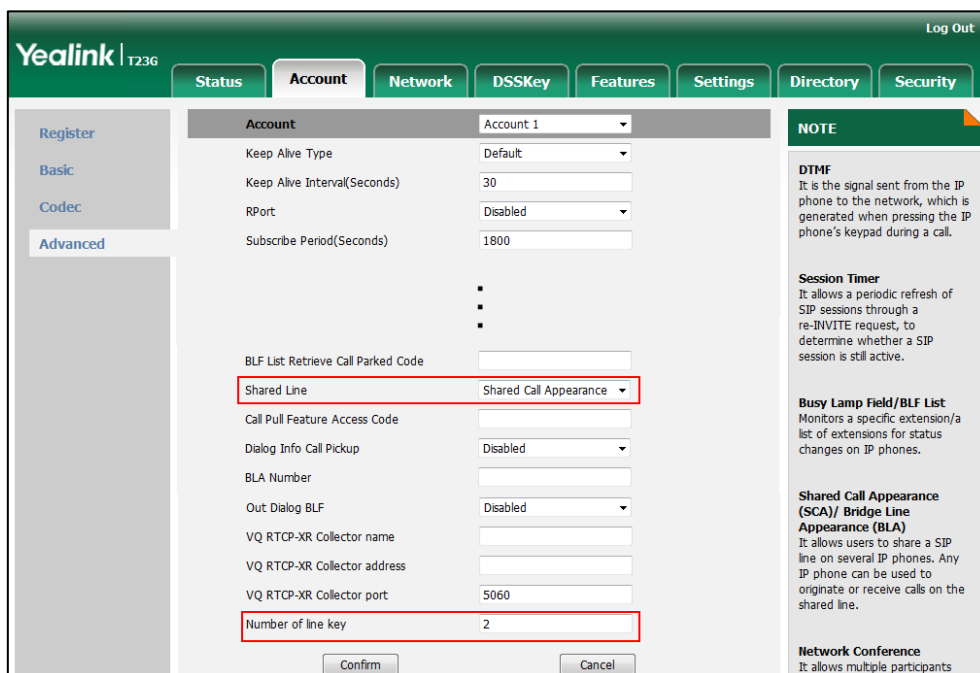

4. Click **Confirm** to accept the change.

To configure the call pull feature access code via web user interface:

1. Click on **Account->Advanced**.
2. Select the desired account from the pull-down list of **Account**.

- Enter the call pull feature access code (e.g., *11) in the **Call Pull Feature Access Code** field.

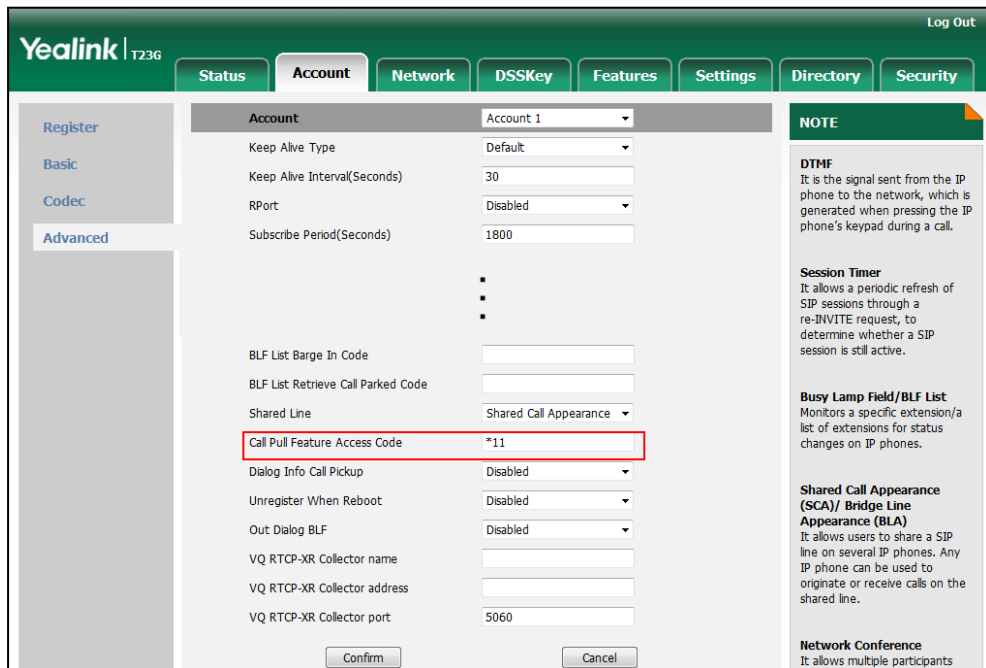

- Click **Confirm** to accept the change.

To configure the private hold soft key via web user interface:

- Click on **Settings->Softkey Layout**.
- Select **Enabled** from the pull-down list of **Custom Softkey**.
- Select **On Talk** from the pull-down list of **Call States**.
- Select **Private Hold** from the **Unselected Softkeys** column and then click  .
The **Private Hold** appears in the **Selected Softkeys** column.

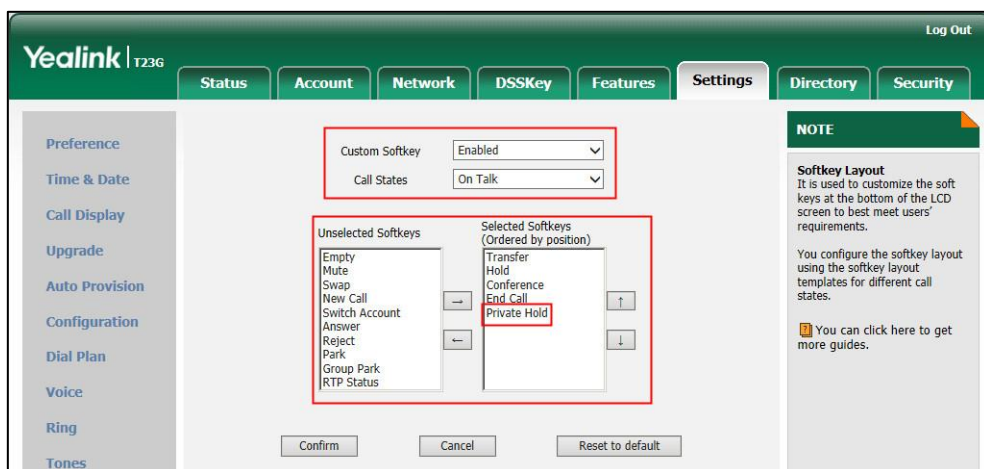

- Click **Confirm** to accept the change.

To configure a private hold key via web user interface:

1. Click on **DSSKey**->**Line Key**.
2. In the desired DSS key field, select **Private Hold** from the pull-down list of **Type**.
3. (Optional.) Enter the string that will appear on the LCD screen in the **Label** field.

Key	Type	Value	Label	Line	Extension
Line Key1	Line		1011	Line 1	
Line Key2	Private Hold			N/A	
Line Key3	ACD			N/A	

NOTE
Line Keys allow you to quickly access features such as recall and voice mail.
You can click here to get more guides.

4. Click **Confirm** to accept the change.

To configure a private hold key via phone user interface:

1. Press **Menu**->**Features**->**DSS Keys**.
2. Press **Left** or **Right**, or the **Switch** soft key to select **Key Event** from the **Type** field.
3. Press **Left** or **Right**, or the **Switch** soft key to select **Private Hold** from the **Key Type** field.
4. (Optional.) Enter a string that will appear on the LCD screen in the **Label** field.
5. Press the **Save** soft key to accept the change or the **Back** soft key to cancel.

Bridge Lines Appearance (BLA)

BLA allows users to share a SIP line on two or more IP phones. Users can monitor the specific extension (BLA number) for status changes on each IP phone. To use this feature, a BLA group should be pre-configured on the server and one of them is specified as a BLA number. BLA depends on support from a SIP server.

Any IP phone can be used to originate or receive calls on the bridge line. An incoming call to the BLA number can be presented to multiple phones in the group simultaneously. The incoming call can be answered on any IP phone of the group but not all.

IP phones support BLA using a SUBSCRIBE/NOTIFY mechanism as specified in [RFC 3265](#). The event used is:

- "dialog" for bridged line appearance subscribe and notify

If the call is placed on public hold, the held call is available for all phones in the group to retrieve.

Procedure

BLA can be configured using the configuration files or locally.

<p>Configuration File</p>	<p><MAC>.cfg</p>	<p>Configure the registration line type.</p> <p>Parameters: account.X.shared_line</p> <p>Configure the BLA number.</p> <p>Parameters: account.X.bla_number</p> <p>Configure the period of BLA subscription.</p> <p>Parameters: account.X.bla_subscribe_period</p>
<p>Local</p>	<p>Web User Interface</p>	<p>Configure the registration line type.</p> <p>Configure the BLA number.</p> <p>Configure the period of BLA subscription.</p> <p>Navigate to: http://<phoneIPAddress>/servlet? p=account-adv&q=load&acc=0</p>

Details of Configuration Parameters:

Parameters	Permitted Values	Default
<p>account.X.shared_line</p>	<p>0, 1 or 3</p>	<p>0</p>
<p>Description: Configures the registration line type.</p> <p>0-Disabled 1-Shared Call Appearance 3-Draft BLA</p> <p>X ranges from 1 to 16 (for SIP-T48G/T46G/T29G) X ranges from 1 to 12 (for SIP-T42G) X ranges from 1 to 6 (for SIP-T41P/T27P) X ranges from 1 to 3 (for SIP-T23P/G)</p>		

Parameters	Permitted Values	Default
<p>X ranges from 1 to 2 (for SIP-T21(P) E2) X is equal to 1 (for SIP-T19(P) E2)</p> <p>Web User Interface: Account->Advanced->Shared Line</p> <p>Phone User Interface: None</p>		
account.X.bla_number	String within 99 characters	Blank
<p>Description: Configures the BLA number for account X.</p> <p>X ranges from 1 to 16 (for SIP-T48G/T46G/T29G) X ranges from 1 to 12 (for SIP-T42G) X ranges from 1 to 6 (for SIP-T41P/T27P) X ranges from 1 to 3 (for SIP-T23P/G) X ranges from 1 to 2 (for SIP-T21(P) E2) X is equal to 1 (for SIP-T19(P) E2)</p> <p>Example: account.1.bla_number = 14084588327</p> <p>Note: It works only if the value of the parameter "account.X.shared_line" is set to 3 (Draft BLA).</p> <p>Web User Interface: Account->Advanced->BLA Number</p> <p>Phone User Interface: None</p>		
account.X.bla_subscribe_period	Integer from 60 to 7200	300
<p>Description: Configures the period (in seconds) of the BLA subscription for account X.</p> <p>X ranges from 1 to 16 (for SIP-T48G/T46G/T29G) X ranges from 1 to 12 (for SIP-T42G) X ranges from 1 to 6 (for SIP-T41P/T27P) X ranges from 1 to 3 (for SIP-T23P/G) X ranges from 1 to 2 (for SIP-T21(P) E2) X is equal to 1 (for SIP-T19(P) E2)</p>		

Parameters	Permitted Values	Default
<p>Note: It works only if the value of the parameter "account.X.shared_line" is set to 3 (Draft BLA).</p> <p>Web User Interface: Account->Advanced->BLA Subscription Period</p> <p>Phone User Interface: None</p>		

To configure the BLA feature via web user interface:

1. Click on **Account->Advanced**.
2. Select the desired account from the pull-down list of **Account**.
3. Select **Shared Call Appearance** from the pull-down list of **Draft BLA**.
4. Enter the desired value in the **BLA Number** field.
5. Enter the desired value in the **BLA Subscription Period** field.

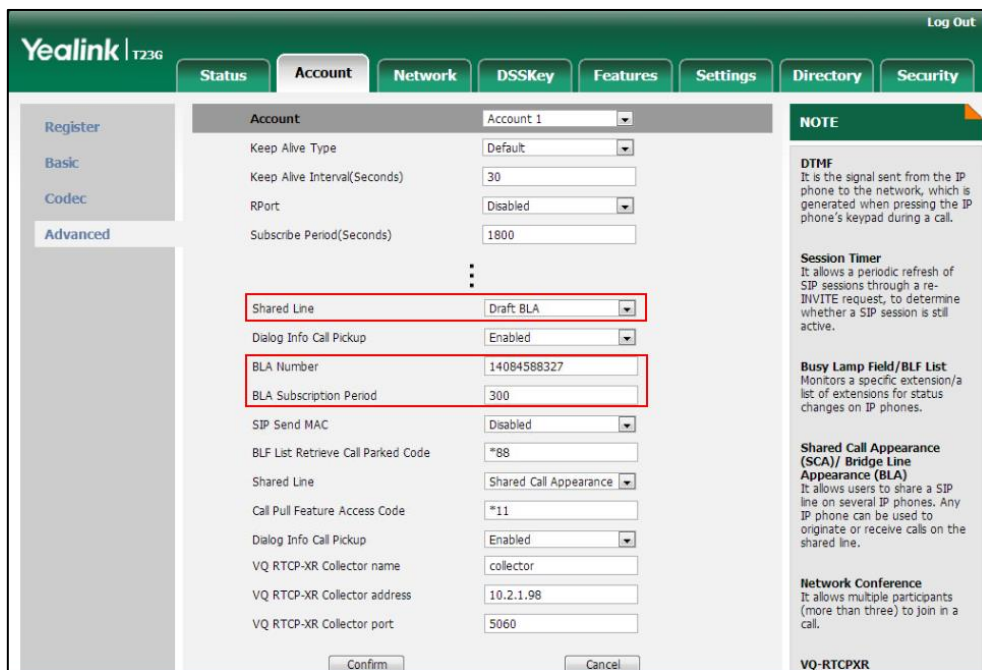

6. Click **Confirm** to accept the change.

Message Waiting Indicator

Message Waiting Indicator (MWI) informs users of the number of messages waiting in their mailbox without calling the mailbox. IP phones support both audio and visual MWI when receiving new voice messages. MWI will be indicated in four ways: a warning tone, an indicator message (including a voice mail icon) on the LCD screen, the power

indicator LED slow flashes red and the MESSAGE key LED lights up (MESSAGE key LED is only applicable to SIP-T29G/T27P/T23P/T23G/T21(P) E2 IP phones). For more information on power indicator LED, refer to [Power Indicator LED](#) on page 91.

IP phones support both solicited and unsolicited MWI.

Unsolicited MWI

Unsolicited MWI is a server related feature. The IP phone sends a SUBSCRIBE message to the server for message-summary updates. The server sends a message-summary NOTIFY within the subscription dialog each time the MWI status changes.

Solicited MWI

For solicited MWI, you must enable MWI subscription feature on IP phones. IP phones support subscribing the MWI messages to the account or the voice mail number.

Procedure

Configuration changes can be performed using the configuration files or locally.

<p>Configuration File</p>	<p><MAC>.cfg</p>	<p>Configure subscribe for MWI.</p> <p>Parameters:</p> <p>account.X.subscribe_mwi</p> <p>account.X.subscribe_mwi_expires</p> <p>Configure subscribe MWI to voice mail.</p> <p>Parameters:</p> <p>account.X.subscribe_mwi_to_vm</p> <p>Configure the voice mail number for account X.</p> <p>Parameter:</p> <p>voice_mail.number.X</p> <p>Configure the presentation of audio and visual MWI.</p> <p>Parameter:</p> <p>account.X.display_mwi.enable</p>
<p>Local</p>	<p>Web User Interface</p>	<p>Configure subscribe for MWI.</p> <p>Configure subscribe MWI to voice mail.</p> <p>Configure the voice mail number for account X.</p> <p>Configure the presentation of audio and visual MWI.</p> <p>Navigate to:</p>

		http://<phoneIPAddress>/servlet?p=account-adv&q=load&acc=0
	Phone User Interface	Configure the voice mail number for account X.

Details of Configuration Parameters:

Parameters	Permitted Values	Default
account.X.subscribe_mwi	0 or 1	0
<p>Description: Enables or disables the IP phone to subscribe the message waiting indicator for account X. 0-Disabled 1-Enabled If it is set to 1 (Enabled), the IP phone will send a SUBSCRIBE message to the server for message-summary updates. If it is set to 0 (Disabled), the server automatically sends a message-summary NOTIFY in a new dialog each time the MWI status changes. (This requires server support) X ranges from 1 to 16 (for SIP-T48G/T46G/T29G) X ranges from 1 to 12 (for SIP-T42G) X ranges from 1 to 6 (for SIP-T41P/T27P) X ranges from 1 to 3 (for SIP-T23P/G) X ranges from 1 to 2 (for SIP-T21(P) E2) X is equal to 1 (for SIP-T19(P) E2)</p> <p>Web User Interface: Account->Advanced->Subscribe for MWI</p> <p>Phone User Interface: None</p>		
account.X.subscribe_mwi_expires	Integer from 0 to 84600	3600
<p>Description: Configures MWI subscribe expiry time (in seconds) for account X. The IP phone is able to successfully refresh the SUBSCRIBE for message-summary events before expiration of the subscription dialog. X ranges from 1 to 16 (for SIP-T48G/T46G/T29G) X ranges from 1 to 12 (for SIP-T42G)</p>		

Parameters	Permitted Values	Default
<p>X ranges from 1 to 6 (for SIP-T41P/T27P) X ranges from 1 to 3 (for SIP-T23P/G) X ranges from 1 to 2 (for SIP-T21(P) E2) X is equal to 1 (for SIP-T19(P) E2)</p> <p>Note: It works only if the value of the parameter "account.X.subscribe_mwi" is set to 1 (Enabled).</p> <p>Web User Interface: Account->Advanced->MWI Subscription Period (Seconds)</p> <p>Phone User Interface: None</p>		
account.X.subscribe_mwi_to_vm	0 or 1	0
<p>Description: Enables or disables the IP phone to subscribe the message waiting indicator to the voice mail number for account X.</p> <p>0-Disabled 1-Enabled</p> <p>X ranges from 1 to 16 (for SIP-T48G/T46G/T29G) X ranges from 1 to 12 (for SIP-T42G) X ranges from 1 to 6 (for SIP-T41P/T27P) X ranges from 1 to 3 (for SIP-T23P/G) X ranges from 1 to 2 (for SIP-T21(P) E2) X is equal to 1 (for SIP-T19(P) E2)</p> <p>Note: It works only if the value of the parameters "account.X.subscribe_mwi" is set to 1 (Enabled) and "voice_mail.number.X" is configured.</p> <p>Web User Interface: Account->Advanced->Subscribe MWI To Voice Mail</p> <p>Phone User Interface: None</p>		
voice_mail.number.X	String within 99 characters	Blank
<p>Description: Configures the voice mail number for account X. X ranges from 1 to 16 (for SIP-T48G/T46G/T29G)</p>		

Parameters	Permitted Values	Default
<p>X ranges from 1 to 12 (for SIP-T42G) X ranges from 1 to 6 (for SIP-T41P/T27P) X ranges from 1 to 3 (for SIP-T23P/G) X ranges from 1 to 2 (for SIP-T21(P) E2) X is equal to 1 (for SIP-T19(P) E2)</p> <p>Example: voice_mail.number.1 = 1234</p> <p>Web User Interface: Account->Advanced->Voice Mail</p> <p>Phone User Interface: Menu->Message->Voice Mail->Set Voice Mail->AccountX Code</p>		
account.X.display_mwi.enable	0 or 1	1
<p>Description: Enables or disables the IP phone to present audio and visual MWI when receiving new voice messages.</p> <p>0-Disabled 1-Enabled</p> <p>X ranges from 1 to 16 (for SIP-T48G/T46G/T29G) X ranges from 1 to 12 (for SIP-T42G) X ranges from 1 to 6 (for SIP-T41P/T27P) X ranges from 1 to 3 (for SIP-T23P/G) X ranges from 1 to 2 (for SIP-T21(P) E2) X is equal to 1 (for SIP-T19(P) E2)</p> <p>Note: It always works at the time of Unsolicited MWI; at the time of solicited MWI, MWI subscription feature should be configured in advance. To present audio MWI, you also need to set the value of the parameter "features.voice_mail_tone_enable" to 1 (Enabled) in advance.</p> <p>Web User Interface: Account->Advanced->Voice Mail Display</p> <p>Phone User Interface: None</p>		

To configure subscribe for MWI via web user interface:

1. Click on **Account->Advanced**.
2. Select the desired account from the pull-down list of **Account**.

3. Select the desired value from the pull-down list of **Subscribe for MWI**.
4. Enter the period time in the **MWI Subscription Period(Seconds)** field.

The screenshot shows the 'Account' settings page for 'Account 1'. The 'Subscribe for MWI' dropdown menu is set to 'Enabled' and the 'MWI Subscription Period(Seconds)' text input field contains the value '3600'. A red rectangular box highlights these two fields. Other settings include 'Keep Alive Type' (Default), 'Keep Alive Interval(Seconds)' (30), 'RPort' (Disabled), 'DTMF Type' (RFC2833), 'DTMF Info Type' (DTMF-Relay), 'DTMF Payload Type(96~127)' (101), 'Retransmission' (Disabled), 'Subscribe Register' (Disabled), and 'Subscribe MWI To Voice Mail' (Disabled).

5. Click **Confirm** to accept the change.

To configure subscribe MWI to voice mail via web user interface:

1. Click on **Account->Advanced**.
2. Select the desired account from the pull-down list of **Account**.
3. Select **Enabled** from the pull-down list of **Subscribe for MWI**.
4. Select the desired value from the pull-down list of **Subscribe MWI To Voice Mail**.
5. Enter the desired voice number in the **Voice Mail** field.

The screenshot shows the 'Account' settings page for 'Account 1'. The 'Subscribe for MWI' dropdown menu is set to 'Enabled', the 'Subscribe MWI To Voice Mail' dropdown menu is set to 'Enabled', and the 'Voice Mail' text input field contains the value '1234'. A red rectangular box highlights these three fields. Other settings include 'Keep Alive Type' (Default), 'Keep Alive Interval(Seconds)' (30), 'RPort' (Disabled), 'Subscribe Period(Seconds)' (1800), 'DTMF Type' (RFC2833), 'DTMF Info Type' (DTMF-Relay), 'DTMF Payload Type(96~127)' (101), 'Retransmission' (Disabled), 'Subscribe Register' (Disabled), 'MWI Subscription Period(Seconds)' (3600), 'Voice Mail Display' (Enabled), and 'Caller ID Source' (FROM).

6. Click **Confirm** to accept the change.

To configure the presentation of audio and visual MWI via web user interface:

1. Click on **Account->Advanced**.
2. Select the desired account from the pull-down list of **Account**.

- Select the desired value from the pull-down list of **Voice Mail Display**.

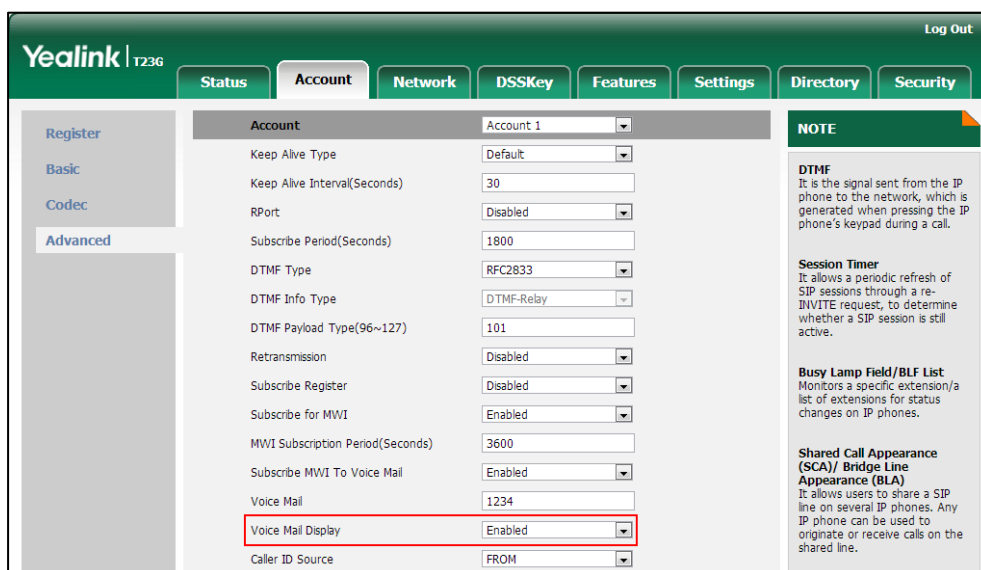

- Click **Confirm** to accept the change.

Short Message Service (SMS)

SMS feature allows users to send and receive text messages using Yealink IP phones. It depends on support from a SIP server.

Procedure

Configuration changes can be performed using the configuration files.

Configuration File	<y0000000000xx>.cfg	Configure SMS for the IP phone. Parameter: features.text_message.enable
---------------------------	---------------------	--

Details of Configuration Parameters:

Parameters	Permitted Values	Default
features.text_message.enable	0 or 1	1
<p>Description: Enables or disables the IP phone to send or receive text message(s).</p> <p>0-Disabled 1-Enabled</p> <p>Web User Interface: None</p>		

Parameters	Permitted Values	Default
Phone User Interface: None		

Multicast Paging

Multicast paging allows IP phones to send/receive Real-time Transport Protocol (RTP) streams to/from the pre-configured multicast address(es) without involving SIP signaling. Up to 10 listening multicast addresses can be specified on the IP phone.

Sending RTP Stream

Users can send an RTP stream without involving SIP signaling by pressing a configured multicast paging key or a paging list key. A multicast address (IP: Port) should be assigned to the multicast paging key, which is defined to transmit RTP stream to a group of designated IP phones. When the IP phone sends the RTP stream to a pre-configured multicast address, each IP phone preconfigured to listen to the multicast address can receive the RTP stream. When the originator stops sending the RTP stream, the subscribers stop receiving it.

Procedure

Configuration changes can be performed using the configuration files or locally.

Configuration File	<y0000000000xx>.cfg	Specify a multicast codec for the IP phone to send the RTP stream. Parameter: multicast.codec Configure the multicast IP address and port number for a paging list key. Parameter: multicast.paging_address.X.ip_address Configure the multicast paging group name for a paging list key. Parameter: multicast.paging_address.X.label Assign a multicast paging key. Parameters: linekey.X.type/
---------------------------	---------------------	---

		<p>expansion_module.X.key.Y.type linekey.X.value/ expansion_module.X.key.Y.value linekey.X.label/ expansion_module.X.key.Y.label</p> <p>Assign a paging list key.</p> <p>Parameter:</p> <p>linekey.X.type/ expansion_module.X.key.Y.type linekey.X.label/ expansion_module.X.key.Y.label</p>
Local	Web User Interface	<p>Specify a multicast codec for the IP phone to send the RTP stream.</p> <p>Navigate to:</p> <p>http://<phoneIPAddress>/servlet?parameters=features-general&q=load</p> <p>Configure the multicast IP address and port number for a paging list key.</p> <p>Configure the multicast paging group name for a paging list key.</p> <p>Navigate to:</p> <p>http://<phoneIPAddress>/servlet?parameters=contacts-multicastIP&q=load</p> <p>Assign a multicast paging key or a paging list key.</p> <p>Navigate to:</p> <p>http://<phoneIPAddress>/servlet?parameters=dsskey&q=load&model=0</p>
	Phone User Interface	<p>Configure the multicast IP address and port number for a paging list key.</p> <p>Configure the multicast paging group name for a paging list key.</p> <p>Assign a multicast paging key or a paging list key.</p>

Details of the Configuration Parameter:

Parameters	Permitted Values	Default
multicast.codec	PCMU, PCMA, G729, G722	G722
<p>Description: Configures the codec of multicast paging.</p> <p>Example: multicast.codec = G722</p> <p>Note: It is not applicable to SIP-T19(P) E2 IP phones.</p> <p>Web User Interface: Features->General Information->Multicast Codec</p> <p>Phone User Interface: None</p>		
multicast.paging_address.X.ip_address (X ranges from 1 to 10)	String	Blank
<p>Description: Configures the IP address and port number of the multicast paging group in the paging list. It will be displayed on the LCD screen when placing the multicast paging call.</p> <p>Example: multicast.paging_address.1.ip_address = 224.5.6.20:10008 multicast.paging_address.2.ip_address = 224.1.6.25:1001</p> <p>Note: The valid multicast IP addresses range from 224.0.0.0 to 239.255.255.255.</p> <p>Web User Interface: Directory->Multicast IP->Paging List->Paging Address</p> <p>Phone User Interface: Menu->Features->Paging List->Option->Edit->Address</p>		
multicast.paging_address.X.label (X ranges from 1 to 10)	String	Blank
<p>Description: Configures the name of the multicast paging group to be displayed in the paging list. It will be displayed on the LCD screen when placing the multicast paging calls.</p> <p>Example:</p>		

Parameters	Permitted Values	Default
multicast.paging_address.1.label = Product multicast.paging_address.2.label = Sales Web User Interface: Directory->Multicast IP->Paging List->Label Phone User Interface: Menu->Features->Paging List->Option->Edit->Label		

Multicast Paging Key

For more information on how to configure the DSS Key, refer to [Appendix D: Configuring DSS Key](#) on page 751.

Parameters	Permitted Values	Default
linekey.X.type/ expansion_module.X.key.Y.type	24	Refer to the following content
<p>Description: Configures a DSS key as a multicast paging key on the IP phone. The digit 24 stands for the key type Multicast Paging. For line keys: X ranges from 1 to 29 (for SIP-T48G) X ranges from 1 to 27 (for SIP-T46G/T29G) X ranges from 1 to 15 (for SIP-T42G/T41P) X ranges from 1 to 21 (for SIP-T27P) X ranges from 1 to 3 (for SIP-T23P/G) X ranges from 1 to 2 (for SIP-T21(P) E2) For ext keys: X ranges from 1 to 6, Y ranges from 1 to 20, 22 to 40 (Ext key 21 cannot be configured).</p> <p>Example: linekey.2.type = 24</p> <p>Default: For SIP-T48G IP phones: The default value of the line key 1-16 is 15, and the default value of the line key 17-29 is 0. For SIP-T46G/T29G IP phones:</p>		

Parameters	Permitted Values	Default
<p>The default value of the line key 1-16 is 15, and the default value of the line key 17-27 is 0.</p> <p>For SIP-T42G IP phones:</p> <p>The default value of the line key 1-12 is 15, and the default value of the line key 13-15 is 0.</p> <p>For SIP-T41P IP phones:</p> <p>The default value of the line key 1-6 is 15, and the default value of the line key 7-15 is 0.</p> <p>For SIP-T27P IP phones:</p> <p>The default value of the line key 1-6 is 15, and the default value of the line key 7-21 is 0.</p> <p>For SIP-T23P/T23G/T21(P) E2 IP phones:</p> <p>The default value is 15.</p> <p>For ext keys:</p> <p>When Y=1, the default value is 37 (Switch).</p> <p>When Y= 2 to 20, 22 to 40, the default value is 0 (NA).</p> <p>Note: It is not applicable to SIP-T19(P) E2 IP phones.</p> <p>Web User Interface:</p> <p>DSSKey->Line Key->Type</p> <p>Phone User Interface:</p> <p>Menu->Features->DSS Keys->Line Key X->Type</p>		
<p>linekey.X.value/ expansion_module.X.key.Y.value</p>	<p>String within 99 characters</p>	<p>Blank</p>
<p>Description:</p> <p>Configures the multicast IP address and port number.</p> <p>For line keys:</p> <p>X ranges from 1 to 29 (for SIP-T48G).</p> <p>X ranges from 1 to 27 (for SIP-T46G/T29G).</p> <p>X ranges from 1 to 15 (for SIP-T42G/T41P).</p> <p>X ranges from 1 to 21 (for SIP-T27P).</p> <p>X ranges from 1 to 3 (for SIP-T23P/G)</p> <p>X ranges from 1 to 2 (for SIP-T21(P) E2)</p> <p>For ext keys:</p> <p>X ranges from 1 to 6, Y ranges from 1 to 20, 22 to 40 (Ext key 21 cannot be configured).</p>		

Parameters	Permitted Values	Default
<p>Example: linekey.1.value = 224.5.5.6:10008</p> <p>Note: The valid multicast IP addresses range from 224.0.0.0 to 239.255.255.255. It is not applicable to SIP-T19(P) E2 IP phones.</p> <p>Web User Interface: DSSKey->Line Key->Value</p> <p>Phone User Interface: Menu->Features->DSS Keys->Line Key X->Value</p>		
linekey.X.label/ expansion_module.X.key.Y.label	String within 99 characters	Blank
<p>Description: (Optional.) Configures the label displayed on the LCD screen for each DSS key.</p> <p>For line keys: X ranges from 1 to 29 (for SIP-T48G) X ranges from 1 to 27 (for SIP-T46G/T29G) X ranges from 1 to 15 (for SIP-T42G/T41P) X ranges from 1 to 21 (for SIP-T27P) X ranges from 1 to 3 (for SIP-T23P/G) X ranges from 1 to 2 (for SIP-T21(P) E2)</p> <p>For ext keys: X ranges from 1 to 6, Y ranges from 1 to 20, 22 to 40 (Ext key 21 cannot be configured).</p> <p>Note: It is not applicable to SIP-T19(P) E2 IP phones.</p> <p>Web User Interface: DSSKey->Line Key->Label</p> <p>Phone User Interface: Menu->Features->DSS Keys->Line Key X->Label</p>		

Paging List key

For more information on how to configure the DSS Key, refer to [Appendix D: Configuring DSS Key](#) on page 751.

Parameters	Permitted Values	Default
<code>linekey.X.type/ programablekey.X.type/ expansion_module.X.key.Y.type</code>	66	Refer to the following content
<p>Description: Configures a DSS key as a paging list key on the IP phone. The digit 66 stands for the key type Paging List.</p> <p>For line keys: X ranges from 1 to 29 (for SIP-T48G) X ranges from 1 to 27 (for SIP-T46G/T29G) X ranges from 1 to 15 (for SIP-T42G/T41P) X ranges from 1 to 21 (for SIP-T27P) X ranges from 1 to 3 (for SIP-T23P/G) X ranges from 1 to 2 (for SIP-T21(P) E2)</p> <p>For programable keys: X=1-10, 12-14 (for SIP-T48G/T46G) X=1-10, 13 (for SIP-T42G/T41P) X=1-14 (for SIP-T29G/T27P) X=1-10, 14 (for SIP-T23P/T23G/T21(P) E2) X=1-9, 13, 14 (for SIP-T19(P) E2)</p> <p>For ext keys: X ranges from 1 to 6, Y ranges from 1 to 20, 22 to 40 (Ext key 21 cannot be configured).</p> <p>Example: <code>linekey.1.type = 66</code></p> <p>Default:</p> <p>For SIP-T48G IP phones: The default value of the line key 1-16 is 15, and the default value of the line key 17-29 is 0.</p> <p>For SIP-T46G/T29G IP phones: The default value of the line key 1-16 is 15, and the default value of the line key 17-27 is 0.</p> <p>For SIP-T42G IP phones:</p>		

Parameters	Permitted Values	Default
<p>The default value of the line key 1-12 is 15, and the default value of the line key 13-15 is 0.</p> <p>For SIP-T41P IP phones:</p> <p>The default value of the line key 1-6 is 15, and the default value of the line key 7-15 is 0.</p> <p>For SIP-T27P IP phones:</p> <p>The default value of the line key 1-6 is 15, and the default value of the line key 7-21 is 0.</p> <p>For SIP-T23P/T23G/T21(P) E2 IP phones:</p> <p>The default value is 15.</p> <p>For programable keys:</p> <p>For SIP-T48G/T46G IP phones:</p> <p>When X=1, the default value is 28 (History).</p> <p>When X=2, the default value is 61 (Directory).</p> <p>When X=3, the default value is 5 (DND).</p> <p>When X=4, the default value is 30 (Menu).</p> <p>When X=5, the default value is 28 (History).</p> <p>When X=6, the default value is 61 (Directory).</p> <p>When X=7, the default value is 0 (NA).</p> <p>When X=8, the default value is 0 (NA).</p> <p>When X=9, the default value is 33 (Status).</p> <p>When X=10, the default value is 0 (NA).</p> <p>When X=12, the default value is 0 (NA).</p> <p>When X=13, the default value is 0 (NA).</p> <p>When X=14, the default value is 2 (Forward).</p> <p>For SIP-T42G/T41P IP phones:</p> <p>When X=1, the default value is 28 (History).</p> <p>When X=2, the default value is 61 (Directory).</p> <p>When X=3, the default value is 5 (DND).</p> <p>When X=4, the default value is 30 (Menu).</p> <p>When X=5, the default value is 28 (History).</p> <p>When X=6, the default value is 61 (Directory).</p> <p>When X=7, the default value is 0 (NA).</p> <p>When X=8, the default value is 0 (NA).</p> <p>When X=9, the default value is 33 (Status).</p>		

Parameters	Permitted Values	Default
<p>When X=10, the default value is 0 (NA).</p> <p>When X=13, the default value is 0 (NA).</p> <p>For SIP-T29G/T27P IP phones:</p> <p>When X=1, the default value is 28 (History).</p> <p>When X=2, the default value is 61 (Directory).</p> <p>When X=3, the default value is 5 (DND).</p> <p>When X=4, the default value is 30 (Menu).</p> <p>When X=5, the default value is 28 (History).</p> <p>When X=6, the default value is 61 (Directory).</p> <p>When X=7, the default value is 0 (NA).</p> <p>When X=8, the default value is 0 (NA).</p> <p>When X=9, the default value is 33 (Status).</p> <p>When X=10, the default value is 0 (NA).</p> <p>When X=11, the default value is 0 (NA).</p> <p>When X=12, the default value is 0 (NA).</p> <p>When X=13, the default value is 0 (NA).</p> <p>When X=14, the default value is 2 (Forward).</p> <p>For SIP-T23P/T23G/T21(P) E2 IP phones:</p> <p>When X=1, the default value is 28 (History).</p> <p>When X=2, the default value is 61 (Directory).</p> <p>When X=3, the default value is 5 (DND).</p> <p>When X=4, the default value is 30 (Menu).</p> <p>When X=5, the default value is 28 (History).</p> <p>When X=6, the default value is 61 (Directory).</p> <p>When X=7, the default value is 0 (NA).</p> <p>When X=8, the default value is 0 (NA).</p> <p>When X=9, the default value is 33 (Status).</p> <p>When X=10, the default value is 0 (NA).</p> <p>When X=14, the default value is 2 (Forward).</p> <p>For SIP-T19(P) E2 IP phones:</p> <p>When X=1, the default value is 28 (History).</p> <p>When X=2, the default value is 61 (Directory).</p> <p>When X=3, the default value is 5 (DND).</p> <p>When X=4, the default value is 30 (Menu).</p> <p>When X=5, the default value is 28 (History).</p>		

Parameters	Permitted Values	Default
<p>When X=6, the default value is 61 (Directory). When X=7, the default value is 0 (NA). When X=8, the default value is 0 (NA). When X=9, the default value is 33 (Status). When X=13, the default value is 0 (NA). When X=14, the default value is 2 (Forward). For ext keys: When Y=1, the default value is 37 (Switch). When Y= 2 to 20, 22 to 40, the default value is 0 (NA).</p> <p>Web User Interface: DSSKey->Line Key->Type</p> <p>Phone User Interface: Menu->Features->DSS Keys->Line Key X->Type</p>		
<p>linekey.X.label/ programablekey.X.label/ expansion_module.X.key.Y.label</p>	<p>String within 99 characters</p>	<p>Blank</p>
<p>Description: (Optional.) Configures the label displayed on the LCD screen for each DSS key. For line keys: X ranges from 1 to 29 (for SIPT48G) X ranges from 1 to 27 (for SIPT46G/T29G) X ranges from 1 to 15 (for SIPT42G/T41P) X ranges from 1 to 21 (for SIPT27P) X ranges from 1 to 3 (for SIPT23P/G) X ranges from 1 to 2 (for SIPT21(P) E2) For programable keys: X ranges from 1 to 4. For ext keys: X ranges from 1 to 6, Y ranges from 1 to 20, 22 to 40 (Ext key 21 cannot be configured).</p> <p>Web User Interface: DSSKey->Line Key/Programable Key->Label</p> <p>Phone User Interface: Menu->Features->DSS Keys->Line Key X->Label</p>		

To configure a codec for multicast paging via web user interface:

1. Click on **Features->General Information**.
2. Select the desired codec from the pull-down list of **Multicast Codec**.

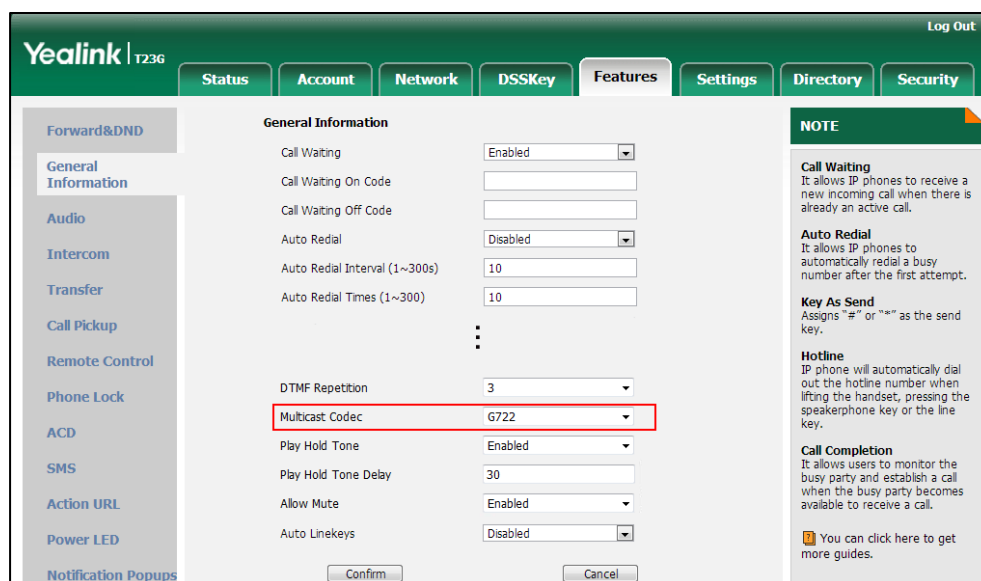

3. Click **Confirm** to accept the change.

To configure two sending multicast addresses via web user interface:

1. Click on **Directory->Multicast IP**.
2. Enter the sending multicast address and port number in the **Paging Address** field.
3. Enter the label in the **Label** field.

The label will appear on the LCD screen when sending the RTP multicast.

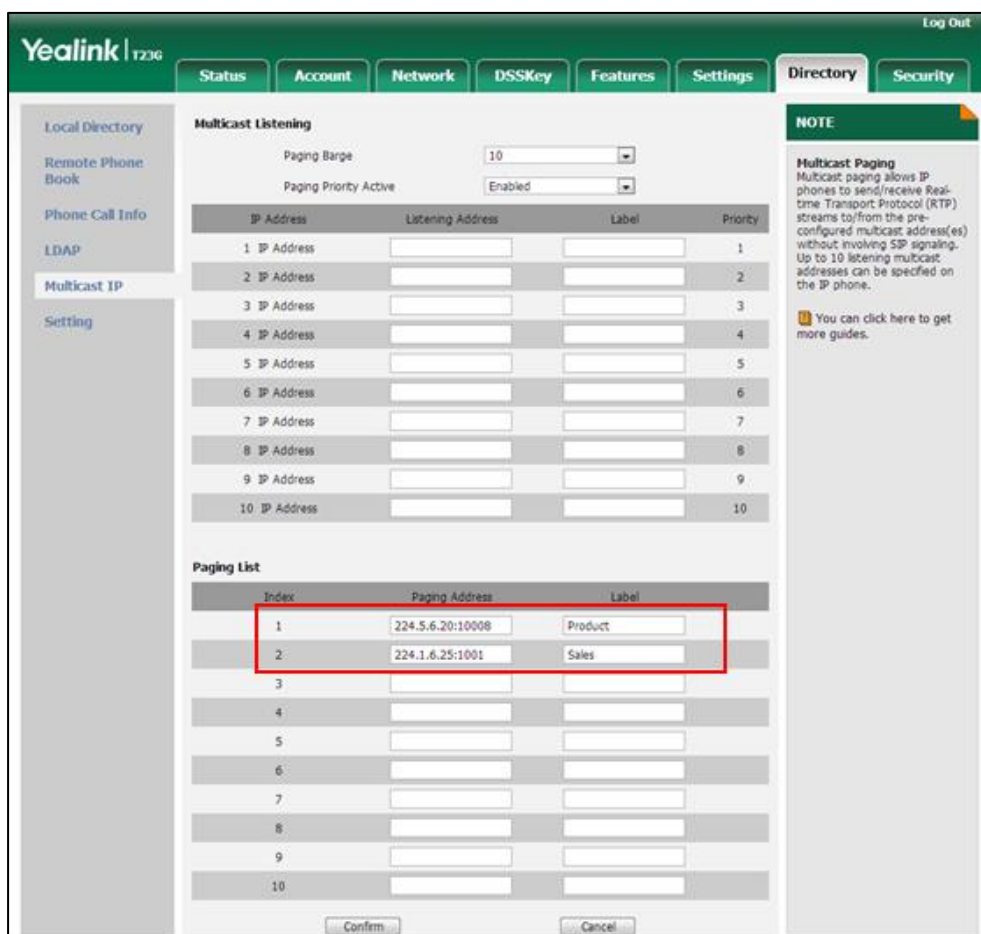

4. Click **Confirm** to accept the change.

To configure a multicast paging key via web user interface:

1. Click on **DSSKey->Line Key**.
2. In the desired DSS key field, select **Multicast Paging** from the pull-down list of **Type**.
3. Enter the multicast IP address and port number in the **Value** field.
The valid multicast IP addresses range from 224.0.0.0 to 239.255.255.255.
4. (Optional.) Enter the string that will appear on the LCD screen in the **Label** field.

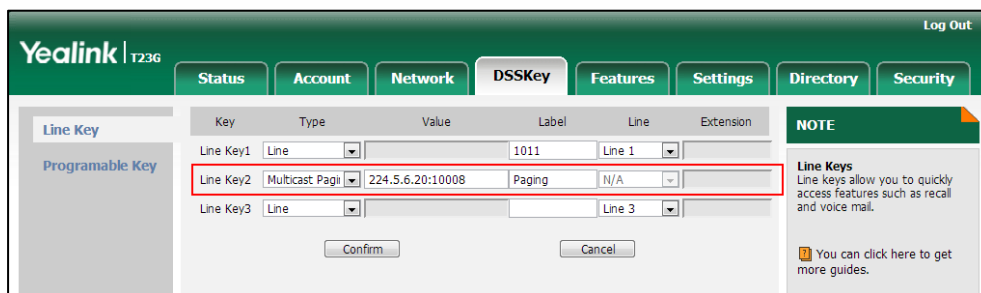

5. Click **Confirm** to accept the change.

To configure a paging list key via web user interface:

1. Click on **DSSKey->Line Key** (or **Programable Key**).
2. In the desired DSS key field, select **Paging List** from the pull-down list of **Type**.
3. (Optional.) Enter the string that will appear on the LCD screen in the **Label** field.

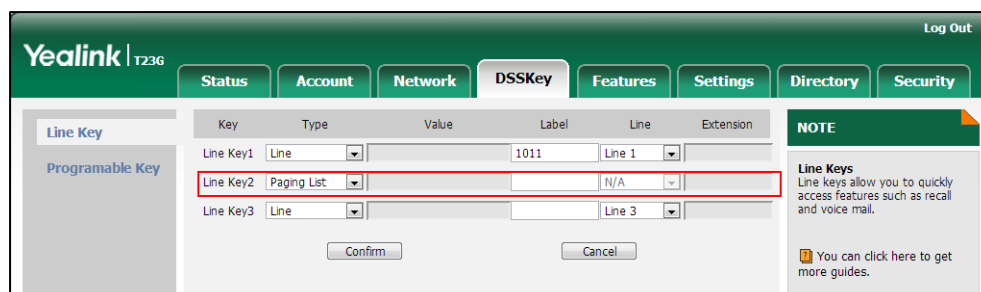

4. Click **Confirm** to accept the change.

To configure a multicast paging key via phone user interface:

1. Press **Menu->Features->DSS Keys**.
2. Select the desired DSS key.
3. Press **◀** or **▶**, or the **Switch** soft key to select **Key Event** from the **Type** field.
4. Press **◀** or **▶**, or the **Switch** soft key to select **Multicast Paging** from the **Key Type** field.
5. (Optional.) Enter the string that will appear on the LCD screen in the **Label** field.
6. Enter the multicast IP address and port number in the **Value** field.
7. Press the **Save** soft key to accept the change.

To configure a paging list key via phone user interface:

1. Press **Menu->Features->DSS Keys**.
2. Select the desired DSS key.
3. Press **◀** or **▶**, or the **Switch** soft key to select **Key Event** from the **Type** field.
4. Press **◀** or **▶**, or the **Switch** soft key to select **Paging List** from the **Key Type** field.
5. (Optional.) Enter the string that will appear on the LCD screen in the **Label** field.
6. Press the **Save** soft key to accept the change.

Receiving RTP Stream

IP phones can receive an RTP stream from the pre-configured multicast address(es) without involving SIP signaling, and can handle the incoming multicast paging calls differently depending on the configurations of Paging Barge and Paging Priority Active.

Paging Barge

This parameter defines the priority of the voice call in progress, and decides how the IP phone handles the incoming multicast paging calls when there is already a voice call in progress. If the value of the parameter is configured as disabled, all incoming multicast paging calls will be automatically ignored. If the value of the parameter is the priority value, the incoming multicast paging calls with higher or equal priority are automatically answered and the ones with lower priority are ignored.

Paging Priority Active

This parameter decides how the IP phone handles the incoming multicast paging calls when there is already a multicast paging call in progress. If the value of the parameter is configured as disabled, the IP phone will automatically ignore all incoming multicast paging calls. If the value of the parameter is configured as enabled, an incoming multicast paging call with higher priority or equal is automatically answered, and the one with lower priority is ignored.

Procedure

Configuration changes can be performed using the configuration files or locally.

<p>Configuration File</p>	<p><y000000000xx>.cfg</p>	<p>Configure the listening multicast address.</p> <p>Parameters: multicast.listen_address.X.ip_address multicast.listen_address.X.label</p> <p>Configure Paging Barge and Paging Priority Active features.</p> <p>Parameters: multicast.receive_priority.enable multicast.receive_priority.priority</p>
<p>Local</p>	<p>Web User Interface</p>	<p>Configure the listening multicast address.</p> <p>Configure Paging Barge and Paging Priority Active features.</p> <p>Navigate to: http://<phoneIPAddress>/servlet?p=contacts-multicastIP&q=load</p>

Details of Configuration Parameters:

Parameters	Permitted Values	Default
multicast.listen_address.X.ip_address (X ranges from 1 to 10)	IP address: port	Blank
<p>Description: Configures the multicast address and port number that the IP phone listens to.</p> <p>Example: multicast.listen_address.1.ip_address = 224.5.6.20:10008</p> <p>Note: The valid multicast IP addresses range from 224.0.0.0 to 239.255.255.255.</p> <p>Web User Interface: Directory->Multicast IP->Multicast Listening->Listening Address</p> <p>Phone User Interface: None</p>		
multicast.listen_address.X.label (X ranges from 1 to 10)	String within 99 characters	Blank
<p>Description: (Optional.) Configures the label to be displayed on the LCD screen when receiving the multicast paging calls.</p> <p>Example: multicast.listen_address.1.label = Paging1</p> <p>Web User Interface: Directory->Multicast IP->Multicast Listening->Label</p> <p>Phone User Interface: None</p>		
multicast.receive_priority.enable	0 or 1	1
<p>Description: Enables or disables the IP phone to handle the incoming multicast paging calls when there is an active multicast paging call on the IP phone.</p> <p>0-Disabled 1-Enabled</p> <p>If it is set to 0 (Disabled), the IP phone will ignore the incoming multicast paging calls when there is an active multicast paging call on the IP phone.</p> <p>If it is set to 1 (Enabled), the IP phone will receive the incoming multicast paging call with a higher or equal priority and ignore that with a lower priority.</p>		

Parameters	Permitted Values	Default
<p>Web User Interface: Directory->Multicast IP->Paging Priority Active</p> <p>Phone User Interface: None</p>		
multicast.receive_priority.priority	Integer from 0 to 10	10
<p>Description: Configures the priority of the voice call (a normal phone call rather than a multicast paging call) in progress. 1 is the highest priority, 10 is the lowest priority.</p> <p>0-Disabled 1-1 2-2 3-3 4-4 5-5 6-6 7-7 8-8 9-9 10-10</p> <p>If it is set to 0 (Disabled), all incoming multicast paging calls will be automatically ignored when a voice call is in progress.</p> <p>If it is not set to 0 (Disabled), the IP phone will receive the incoming multicast paging call with a higher or same priority than this value and ignore that with a lower priority than this value when a voice call is in progress.</p> <p>Web User Interface: Directory->Multicast IP->Paging Barge</p> <p>Phone User Interface: None</p>		

To configure a listening multicast address via web user interface:

1. Click on **Directory->Multicast IP**.
2. Enter the listening multicast address and port number in the **Listening Address** field.

1 is the highest priority and 10 is the lowest priority.

3. Enter the label in the **Label** field.

The label will appear on the LCD screen when receiving the RTP multicast.

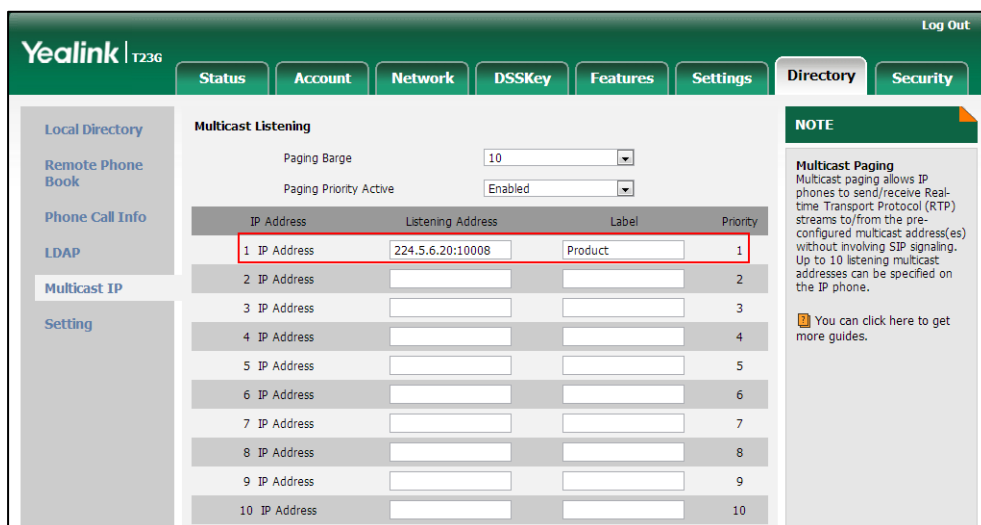

4. Click **Confirm** to accept the change.

To configure paging barge and paging priority active features via web user interface:

1. Click on **Directory->Multicast IP**.
2. Select the desired value from the pull-down list of **Paging Barge**.
3. Select the desired value from the pull-down list of **Paging Priority Active**.

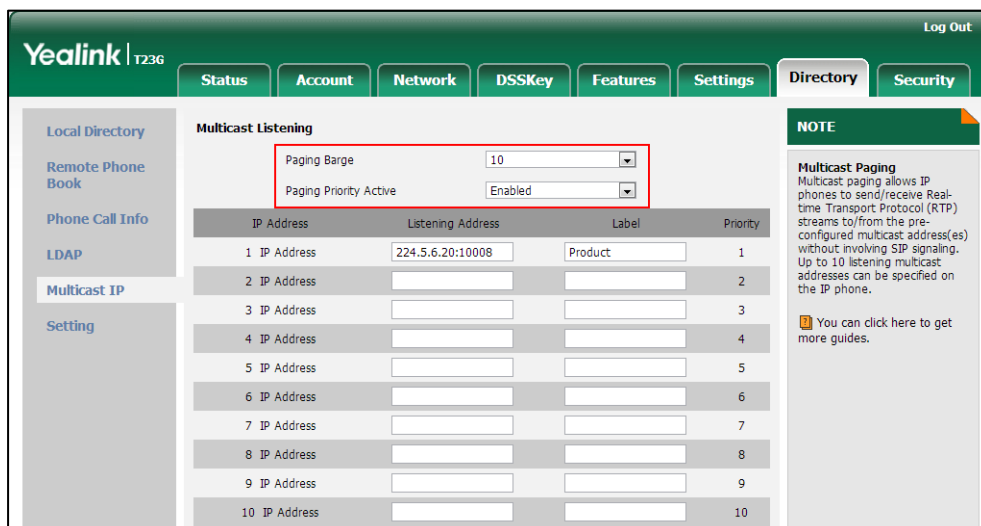

4. Click **Confirm** to accept the change.

Call Recording

Call recording enables users to record calls. It depends on support from a SIP server. When the user presses the call record key, the IP phone sends a record request to the server. IP phones themselves do not have memory to store the recording, what they can

do is to trigger the recording and indicate the recording status.

Normally, there are 2 main methods to trigger a recording on a certain server. We call them record and URL record. Record is for the IP phone to send the server a SIP INFO message containing a specific header. URL record is for the IP phone to send the server an HTTP GET message containing a specific URL. The server processes these messages and decides to start or stop a recording.

Note

This feature is not applicable to SIP-T19(P) E2 IP phones.

Record

When a user presses a record key for the first time during a call, the IP phone sends a SIP INFO message to the server with the specific header "Record: on", and then the recording starts.

Example of a SIP INFO message:

```
Via: SIP/2.0/UDP 10.3.20.14:5060;branch=z9hG4bK1870385345
From: "1009" <sip:1009@10.3.5.199:5060>;tag=1385842459
To: <sip:1006@10.3.5.199:5060>;tag=2383911905
Call-ID: 0_1289812066@10.3.20.14
CSeq: 2 INFO
Contact: <sip:1009@10.3.20.14:5060>
Max-Forwards: 70
User-Agent: Yealink SIPT23G 44.80.0.20
Record: on
Content-Length: 0
```

When the user presses the record key for the second time, the IP phone sends a SIP INFO message to the server with the specific header "Record: off", and then the recording stops.

Example of a SIP INFO message:

```
Via: SIP/2.0/UDP 10.3.20.14:5060;branch=z9hG4bK175716007
From: "1009" <sip:1009@10.3.5.199:5060>;tag=1385842459
To: <sip:1006@10.3.5.199:5060>;tag=2383911905
Call-ID: 0_1289812066@10.3.20.14
CSeq: 3 INFO
Contact: <sip:1009@10.3.20.14:5060>
Max-Forwards: 70
User-Agent: Yealink SIPT23G 44.80.0.20
Record: off
Content-Length: 0
```

URL Record

When a user presses a URL record key for the first time during a call, the IP phone sends an HTTP GET message to the server.

Example of an HTTP GET message:

```
GET /URLRecord/record.xml HTTP/1.1\r\n
Request Method: GET
Request URI: /URLRecord/record.xml
Request version: HTTP/1.1
Host: 10.3.5.97:8080\r\n
User-agent: Yealink SIP-T23G 44.80.0.20 00:15:65:74:B1:50\r\n
```

If the recording is successfully started, the server will respond with a 200 OK message.

Example of a 200 OK message:

```
<YealinkIPPhoneText>
<Title>
  </Title>
<Text>
  The recording session is successfully started.
</Text>
</YealinkIPPhoneText>
```

If the recording fails for some reasons, for example, the recording box is full, the server will respond with a 200 OK message.

Example of a 200 OK message:

```
<YealinkIPPhoneText>
<Title>
  </Title>
<Text>
  Probably the recording box is full.
</Text>
</YealinkIPPhoneText>
```

When the user presses the URL record key for the second time, the IP phone sends an HTTP GET message to the server, and then the server will respond with a 200 OK message.

Example of a 200 OK message:

```
<YealinkIPPhoneText>
<Title>
  </Title>
<Text>
  The recording session is successfully stopped.
</Text>
```

```
</Text>
<YealinkIPPhoneText>
```

Procedure

Call recording key can be configured using the configuration files or locally.

Configuration File	<y0000000000xx>.cfg	Assign a record key. Parameters: linekey.X.type/ expansion_module.X.key.Y.type Assign a URL record key. Parameters: linekey.X.type/ expansion_module.X.key.Y.type linekey.X.value/ expansion_module.X.key.Y.value linekey.X.label/ expansion_module.X.key.Y.label
	Web User Interface	Assign a record key and URL record key. Navigate to: http://<phoneIPAddress>/servlet?p=dsskey&q=load&model=0
Local	Phone User Interface	Assign a record key and URL record key.

Record Key

For more information on how to configure the DSS Key, refer to [Appendix D: Configuring DSS Key](#) on page 751.

Parameters	Permitted Values	Default
linekey.X.type/ expansion_module.X.key.Y.type	25	Refer to the following content
<p>Description: Configures a DSS key as a record key on the IP phone. The digit 25 stands for the key type Record. For line keys: X ranges from 1 to 29 (for SIP-T48G)</p>		

Parameters	Permitted Values	Default
<p>X ranges from 1 to 27 (for SIP-T46G/T29G)</p> <p>X ranges from 1 to 15 (for SIP-T42G/T41P)</p> <p>X ranges from 1 to 21 (for SIP-T27P)</p> <p>X ranges from 1 to 3 (for SIP-T23P/G)</p> <p>X ranges from 1 to 2 (for SIP-T21(P) E2)</p> <p>For ext keys:</p> <p>X ranges from 1 to 6, Y ranges from 1 to 20, 22 to 40 (Ext key 21 cannot be configured).</p> <p>Example:</p> <p>linekey.2.type = 25</p> <p>Default:</p> <p>For SIP-T48G IP phones:</p> <p>The default value of the line key 1-16 is 15, and the default value of the line key 17-29 is 0.</p> <p>For SIP-T46G/T29G IP phones:</p> <p>The default value of the line key 1-16 is 15, and the default value of the line key 17-27 is 0.</p> <p>For SIP-T42G IP phones:</p> <p>The default value of the line key 1-12 is 15, and the default value of the line key 13-15 is 0.</p> <p>For SIP-T41P IP phones:</p> <p>The default value of the line key 1-6 is 15, and the default value of the line key 7-15 is 0.</p> <p>For SIP-T27P IP phones:</p> <p>The default value of the line key 1-6 is 15, and the default value of the line key 7-21 is 0.</p> <p>For SIP-T23P/T23G/T21(P) E2 IP phones:</p> <p>The default value is 15.</p> <p>For ext keys:</p> <p>When Y=1, the default value is 37 (Switch).</p> <p>When Y= 2 to 20, 22 to 40, the default value is 0 (NA).</p> <p>Note: It is not applicable to SIP-T19(P) E2 IP phones.</p> <p>Web User Interface:</p> <p>DSSKey->Line Key->Type</p> <p>Phone User Interface:</p> <p>Menu->Features->DSS Keys->Line Key X->Type</p>		

Parameters	Permitted Values	Default
linekey.X.label/ expansion_module.X.key.Y.label	String within 99 characters	Blank
<p>Description: (Optional.) Configures the label displayed on the LCD screen for each DSS key. For line keys: X ranges from 1 to 29 (for SIP-T48G) X ranges from 1 to 27 (for SIP-T46G/T29G) X ranges from 1 to 15 (for SIP-T42G/T41P) X ranges from 1 to 21 (for SIP-T27P) X ranges from 1 to 3 (for SIP-T23P/G) X ranges from 1 to 2 (for SIP-T21(P) E2) For ext keys: X ranges from 1 to 6, Y ranges from 1 to 20, 22 to 40 (Ext key 21 cannot be configured). Note: It is not applicable to SIP-T19(P) E2 IP phones. Web User Interface: DSSKey->Line Key->Label Phone User Interface: Menu->Features->DSS Keys->Line Key X->Label</p>		

URL Record Key

Parameters	Permitted Values	Default
linekey.X.type/ expansion_module.X.key.Y.type	35	Refer to the following content
<p>Description: Configures a DSS key as a URL record key on the IP phone. The digit 35 stands for the key type URL Record. For line keys: X ranges from 1 to 29 (for SIP-T48G) X ranges from 1 to 27 (for SIP-T46G/T29G) X ranges from 1 to 15 (for SIP-T42G/T41P) X ranges from 1 to 21 (for SIP-T27P)</p>		

Parameters	Permitted Values	Default
<p>X ranges from 1 to 3 (for SIP-T23P/G) X ranges from 1 to 2 (for SIP-T21(P) E2) For ext keys: X ranges from 1 to 6, Y ranges from 1 to 20, 22 to 40 (Ext key 21 cannot be configured). Example: linekey.2.type = 35 Default: For SIP-T48G IP phones: The default value of the line key 1-16 is 15, and the default value of the line key 17-29 is 0. For SIP-T46G/T29G IP phones: The default value of the line key 1-16 is 15, and the default value of the line key 17-27 is 0. For SIP-T42G IP phones: The default value of the line key 1-12 is 15, and the default value of the line key 13-15 is 0. For SIP-T41P IP phones: The default value of the line key 1-6 is 15, and the default value of the line key 7-15 is 0. For SIP-T27P IP phones: The default value of the line key 1-6 is 15, and the default value of the line key 7-21 is 0. For SIP-T23P/T23G/T21(P) E2 IP phones: The default value is 15. For ext keys: When Y=1, the default value is 37 (Switch). When Y= 2 to 20, 22 to 40, the default value is 0 (NA). Note: It is not applicable to SIP-T19(P) E2 IP phones. Web User Interface: DSSKey->Line Key->Type Phone User Interface: Menu->Features->DSS Keys->Line Key X->Type</p>		
linekey.X.value/ expansion_module.X.key.Y.value	String within 99 characters	Blank

Parameters	Permitted Values	Default
<p>Description: Configures the URL to record a call. For line keys: X ranges from 1 to 29 (for SIP-T48G). X ranges from 1 to 27 (for SIP-T46G/T29G). X ranges from 1 to 15 (for SIP-T42G/T41P). X ranges from 1 to 21 (for SIP-T27P). X ranges from 1 to 3 (for SIP-T23P/G) X ranges from 1 to 2 (for SIP-T21(P) E2) For ext keys: X ranges from 1 to 6, Y ranges from 1 to 20, 22 to 40 (Ext key 21 cannot be configured). Example: linekey.1.value = http://10.3.5.97:8080/URLRecord/record.xml Note: It is not applicable to SIP-T19(P) E2 IP phones. Web User Interface: DSSKey->Line Key->Value Phone User Interface: Menu->Features->DSS Keys->Line Key X->Value</p>		
<p>linekey.X.label/ expansion_module.X.key.Y.label</p>	<p>String within 99 characters</p>	<p>Blank</p>
<p>Description: (Optional.) Configures the label displayed on the LCD screen for each DSS key. For line keys: X ranges from 1 to 29 (for SIP-T48G) X ranges from 1 to 27 (for SIP-T46G/T29G) X ranges from 1 to 15 (for SIP-T42G/T41P) X ranges from 1 to 21 (for SIP-T27P) X ranges from 1 to 3 (for SIP-T23P/G) X ranges from 1 to 2 (for SIP-T21(P) E2) For ext keys: X ranges from 1 to 6, Y ranges from 1 to 20, 22 to 40 (Ext key 21 cannot be configured). Note: It is not applicable to SIP-T19(P) E2 IP phones.</p>		

Parameters	Permitted Values	Default
Web User Interface: DSSKey->Line Key->Label Phone User Interface: Menu->Features->DSS Keys->Line Key X->Label		

To configure a record key via web user interface:

1. Click on **DSSKey->Line Key**.
2. In the desired DSS key field, select **Record** from the pull-down list of **Type**.
3. (Optional.) Enter the string that will appear on the LCD screen in the **Label** field.

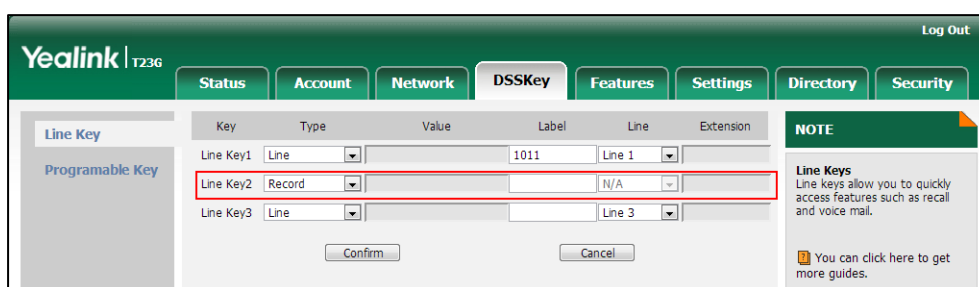

4. Click **Confirm** to accept the change.

To configure a URL record key via web user interface:

1. Click on **DSSKey->Line Key**.
2. In the desired DSS key field, select **URL Record** from the pull-down list of **Type**.
3. Enter the URL in the **Value** field.
4. (Optional.) Enter the string that will appear on the LCD screen in the **Label** field.

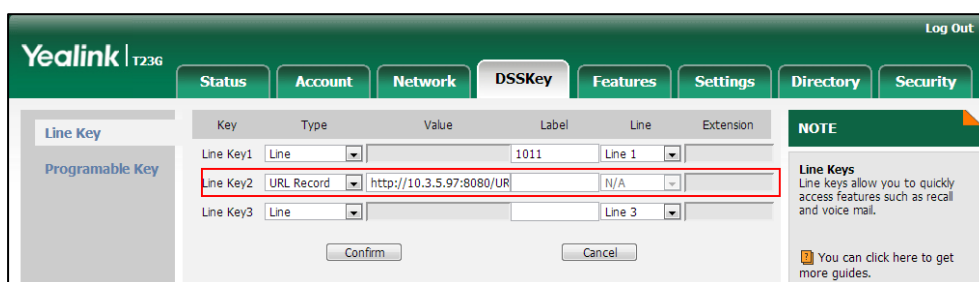

5. Click **Confirm** to accept the change.

To configure a record key via phone user interface:

1. Press **Menu->Features->DSS Keys**.
2. Select the desired DSS key.
3. Press **←** or **→**, or the **Switch** soft key to select **Key Event** from the **Type** field.
4. Press **←** or **→**, or the **Switch** soft key to select **Record** from the **Key Type** field.

5. (Optional.) Enter the string that will appear on the LCD screen in the **Label** field.
6. Press the **Save** soft key to accept the change.

To configure a URL record key via phone user interface:

1. Press **Menu->Features->DSS Keys**.
2. Select the desired DSS key.
3. Press **◀** or **▶**, or the **Switch** soft key to select **URL Record** from the **Type** field.
4. (Optional.) Enter the string that will appear on the LCD screen in the **Label** field.
5. Enter the URL in the **Value** field.
6. Press the **Save** soft key to accept the change.

Hot Desking

Hot desking originates from the definition of being the temporary physical occupant of a work station or surface by a particular employee. A primary motivation for hot desking is cost reduction. Hot desking is regularly used in places where not all employees are in the office at the same time, or not in the office for a long time, which means actual personal offices would often be vacant, consuming valuable space and resources.

Hot desking allows a user to clear registration configurations of all accounts on the IP phone, and then register his account on line 1. To use this feature, you need to assign a hot desking key.

Procedure

Hot Desking feature can be configured using the configuration files or locally.

Configuration File	<y0000000000xx>.cfg	<p>Configure the hot desking login wizard.</p> <p>Parameters:</p> <p>hotdesking.dsskey_register_name_enable</p> <p>hotdesking.dsskey_username_enable</p> <p>hotdesking.dsskey_password_enable</p> <p>hotdesking.dsskey_sip_server_enable</p> <p>hotdesking.dsskey_outbound_enable</p> <p>Assign a hot desking key.</p> <p>Parameters:</p>
---------------------------	---------------------	---

		linekey.X.type/ programablekey.X.type/ expansion_module.X.key.Y.type linekey.X.label/ programablekey.X.label/ expansion_module.X.key.Y.label
Local	Web User Interface	Assign a hot desking key. Navigate to: http://<phoneIPAddress>/servlet ?p=dsskey&q=load&model=0
	Phone User Interface	Assign a hot desking key.

Details of Configuration Parameters:

Parameters	Permitted Values	Default
hotdesking.dsskey_register_name_enable	0 or 1	0
<p>Description: Enables or disables the IP phone to provide input field of register name on the hot desking login wizard when pressing the Hot Desking key.</p> <p>0-Disabled 1-Enabled</p> <p>Web User Interface: None</p> <p>Phone User Interface: None</p>		
hotdesking.dsskey_username_enable	0 or 1	1
<p>Description: Enables or disables the IP phone to provide input field of user name on the hot desking login wizard when pressing the Hot Desking key.</p> <p>0-Disabled 1-Enabled</p> <p>Web User Interface: None</p> <p>Phone User Interface: None</p>		

Parameters	Permitted Values	Default
hotdesking.dsskey_password_enable	0 or 1	1
<p>Description: Enables or disables the IP phone to provide input field of password on the hot desking login wizard when pressing the Hot Desking key.</p> <p>0-Disabled 1-Enabled</p> <p>Web User Interface: None</p> <p>Phone User Interface: None</p>		
hotdesking.dsskey_sip_server_enable	0 or 1	0
<p>Description: Enables or disables the IP phone to provide input field of SIP server on the hot desking login wizard when pressing the Hot Desking key.</p> <p>0-Disabled 1-Enabled</p> <p>Web User Interface: None</p> <p>Phone User Interface: None</p>		
hotdesking.dsskey_outbound_enable	0 or 1	0
<p>Description: Enables or disables the IP phone to provide input field of outbound server on the hot desking login wizard when pressing the Hot Desking key.</p> <p>0-Disabled 1-Enabled</p> <p>Web User Interface: None</p> <p>Phone User Interface: None</p>		

Hot Desking Key

For more information on how to configure the DSS Key, refer to [Appendix D: Configuring DSS Key](#) on page 751.

Parameters	Permitted Values	Default
<code>linekey.X.type/</code> <code>programablekey.X.type/</code> <code>expansion_module.X.key.Y.type</code>	34	Refer to the following content
<p>Description:</p> <p>Configures a DSS key as a hot desking key on the IP phone.</p> <p>The digit 34 stands for the key type Hot Desking.</p> <p>For line keys:</p> <p>X ranges from 1 to 29 (for SIP-T48G) X ranges from 1 to 27 (for SIP-T46G/T29G) X ranges from 1 to 15 (for SIP-T42G/T41P) X ranges from 1 to 21 (for SIP-T27P) X ranges from 1 to 3 (for SIP-T23P/G) X ranges from 1 to 2 (for SIP-T21(P) E2)</p> <p>For programable keys:</p> <p>X=1-10, 12-14 (for SIP-T48G/T46G) X=1-14 (for SIP-T29G) X=1-9, 13, 14 (for SIP-T19(P) E2)</p> <p>For ext keys:</p> <p>X ranges from 1 to 6, Y ranges from 1 to 20, 22 to 40 (Ext key 21 cannot be configured).</p> <p>Example:</p> <p><code>linekey.1.type = 34</code></p> <p>Default:</p> <p>For SIP-T48G IP phones:</p> <p>The default value of the line key 1-16 is 15, and the default value of the line key 17-29 is 0.</p> <p>For SIP-T46G/T29G IP phones:</p> <p>The default value of the line key 1-16 is 15, and the default value of the line key 17-27 is 0.</p> <p>For SIP-T42G IP phones:</p> <p>The default value of the line key 1-12 is 15, and the default value of the line key</p>		

Parameters	Permitted Values	Default
<p>13-15 is 0.</p> <p>For SIP-T41P IP phones:</p> <p>The default value of the line key 1-6 is 15, and the default value of the line key 7-15 is 0.</p> <p>For SIP-T27P IP phones:</p> <p>The default value of the line key 1-6 is 15, and the default value of the line key 7-21 is 0.</p> <p>For SIP-T23P/T23G/T21(P) E2 IP phones:</p> <p>The default value is 15.</p> <p>For programable keys:</p> <p>For SIP-T48G/T46G IP phones:</p> <p>When X=1, the default value is 28 (History).</p> <p>When X=2, the default value is 61 (Directory).</p> <p>When X=3, the default value is 5 (DND).</p> <p>When X=4, the default value is 30 (Menu).</p> <p>When X=5, the default value is 28 (History).</p> <p>When X=6, the default value is 61 (Directory).</p> <p>When X=7, the default value is 0 (NA).</p> <p>When X=8, the default value is 0 (NA).</p> <p>When X=9, the default value is 33 (Status).</p> <p>When X=10, the default value is 0 (NA).</p> <p>When X=12, the default value is 0 (NA).</p> <p>When X=13, the default value is 0 (NA).</p> <p>When X=14, the default value is 2 (Forward).</p> <p>For SIP-T29G IP phones:</p> <p>When X=1, the default value is 28 (History).</p> <p>When X=2, the default value is 61 (Directory).</p> <p>When X=3, the default value is 5 (DND).</p> <p>When X=4, the default value is 30 (Menu).</p> <p>When X=5, the default value is 28 (History).</p> <p>When X=6, the default value is 61 (Directory).</p> <p>When X=7, the default value is 0 (NA).</p> <p>When X=8, the default value is 0 (NA).</p> <p>When X=9, the default value is 33 (Status).</p> <p>When X=10, the default value is 0 (NA).</p>		

Parameters	Permitted Values	Default
<p>When X=11, the default value is 0 (NA). When X=12, the default value is 0 (NA). When X=13, the default value is 0 (NA). When X=14, the default value is 2 (Forward).</p> <p>For SIP-T19(P) E2 IP phones:</p> <p>When X=1, the default value is 28 (History). When X=2, the default value is 61 (Directory). When X=3, the default value is 5 (DND). When X=4, the default value is 30 (Menu). When X=5, the default value is 28 (History). When X=6, the default value is 61 (Directory). When X=7, the default value is 0 (NA). When X=8, the default value is 0 (NA). When X=9, the default value is 33 (Status). When X=13, the default value is 0 (NA). When X=14, the default value is 2 (Forward).</p> <p>For ext keys: When Y=1, the default value is 37 (Switch). When Y= 2 to 20, 22 to 40, the default value is 0 (NA).</p> <p>Web User Interface: DSSKey->Line Key->Type</p> <p>Phone User Interface: Menu->Features->DSS Keys->Line Key X->Type</p>		
<p>linekey.X.label/ programablekey.X.label/ expansion_module.X.key.Y.label</p>	<p>String within 99 characters</p>	<p>Blank</p>
<p>Description: (Optional.) Configures the label displayed on the LCD screen for each DSS key. For line keys: X ranges from 1 to 29 (for SIP-T48G) X ranges from 1 to 27 (for SIP-T46G/T29G) X ranges from 1 to 15 (for SIP-T42G/T41P) X ranges from 1 to 21 (for SIP-T27P) X ranges from 1 to 3 (for SIP-T23P/G)</p>		

Parameters	Permitted Values	Default
<p>X ranges from 1 to 2 (for SIP-T21(P) E2)</p> <p>For programmable keys: X ranges from 1 to 4.</p> <p>For ext keys: X ranges from 1 to 6, Y ranges from 1 to 20, 22 to 40 (Ext key 21 cannot be configured).</p> <p>Web User Interface: DSSKey->Line Key->Label</p> <p>Phone User Interface: Menu->Features->DSS Keys->Line Key X->Label</p>		

To configure a hot desking key via web user interface:

1. Click on **DSSKey->Line Key**.
2. In the desired DSS key field, select **Hot Desking** from the pull-down list of **Type**.
3. (Optional.) Enter the string that will appear on the LCD screen in the **Label** field.

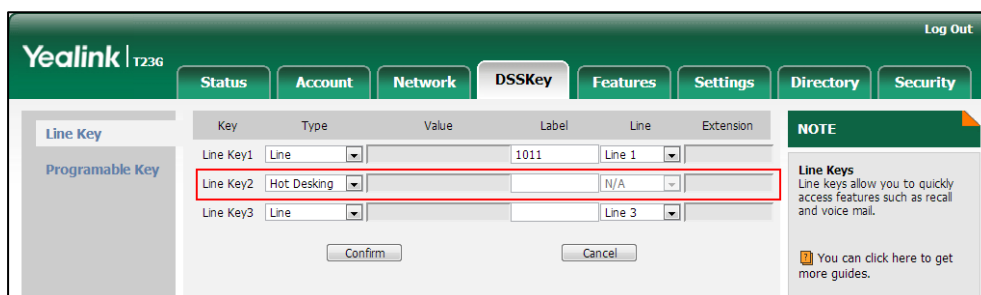

4. Click **Confirm** to accept the change.

To configure a hot desking key via phone user interface:

1. Press **Menu->Features->DSS Keys**.
2. Select the desired DSS key.
3. Press **◀** or **▶**, or the **Switch** soft key to select **Key Event** from the **Type** field.
4. Press **◀** or **▶**, or the **Switch** soft key to select **Hot Desking** from the **Key Type** field.
5. (Optional.) Enter the string that will appear on the LCD screen in the **Label** field.
6. Press the **Save** soft key to accept the change.

Logon Wizard

Logon wizard allows IP phones to provide the logon wizard during the first startup.

Note Logon wizard feature works only if no registered account on the IP phone.

Procedure

Logon wizard can be configured using the configuration files or locally.

Configuration File	<y0000000000xx>.cfg	Configure the logon wizard. Parameters: phone_setting.logon_wizard hotdesking.startup_register_name_enable hotdesking.startup_username_enable hotdesking.startup_password_enable hotdesking.startup_sip_server_enable hotdesking.startup_outbound_enable
Local	Web User Interface	Configure the logon wizard. Navigate to: http://<phoneIPAddress>/servlet?p=features-general&q=load

Details of the Configuration Parameter:

Parameter	Permitted Values	Default
phone_setting.logon_wizard	0 or 1	0
<p>Description:</p> <p>Enables or disables the IP phone to provide the logon wizard during the first startup.</p> <p>0-Disabled 1-Enabled</p> <p>Note: It works only if no registered account on the IP phone.</p> <p>Web User Interface:</p> <p>Features->General Information->Logon Wizard</p> <p>Phone User Interface:</p> <p>None</p>		

Parameter	Permitted Values	Default
hotdesking.startup_register_name_enable	0 or 1	0
<p>Description: Enable or disable the IP phone to provide input field of register name on the logon wizard during the first startup.</p> <p>0-Disabled 1-Enabled</p> <p>Note: It works only if no registered account on the IP phone and the value of the parameter "phone_setting.logon_wizard" is set to 1 (Enabled).</p> <p>Web User Interface: None</p> <p>Phone User Interface: None</p>		
hotdesking.startup_username_enable	0 or 1	1
<p>Description: Enable or disable the IP phone to provide input field of user name on the logon wizard during the first startup.</p> <p>0-Disabled 1-Enabled</p> <p>Note: It works only if no registered account on the IP phone and the value of the parameter "phone_setting.logon_wizard" is set to 1 (Enabled).</p> <p>Web User Interface: None</p> <p>Phone User Interface: None</p>		
hotdesking.startup_password_enable	0 or 1	1
<p>Description: Enable or disable the IP phone to provide input field of password on the logon wizard during the first startup.</p> <p>0-Disabled 1-Enabled</p> <p>Note: It works only if no registered account on the IP phone and the value of the parameter "phone_setting.logon_wizard" is set to 1 (Enabled).</p>		

Parameter	Permitted Values	Default
Web User Interface: None Phone User Interface: None		
hotdesking.startup_sip_server_enable	0 or 1	0
Description: Enables or disables the IP phone to provide input field of SIP server on the logon wizard during the first startup. 0-Disabled 1-Enabled Note: It works only if no registered account on the IP phone and the value of the parameter "phone_setting.logon_wizard" is set to 1 (Enabled). Web User Interface: None Phone User Interface: None		
hotdesking.startup_outbound_enable	0 or 1	0
Description: Enables or disables the IP phone to provide input field of outbound server on the logon wizard during the first startup. 0-Disabled 1-Enabled Note: It works only if no registered account on the IP phone and the value of the parameter "phone_setting.logon_wizard" is set to 1 (Enabled). Web User Interface: None Phone User Interface: None		

To configure logon wizard feature via web user interface:

1. Click on **Features->General Information**.

- Select the desired value from the pull-down list of **Logon Wizard**.

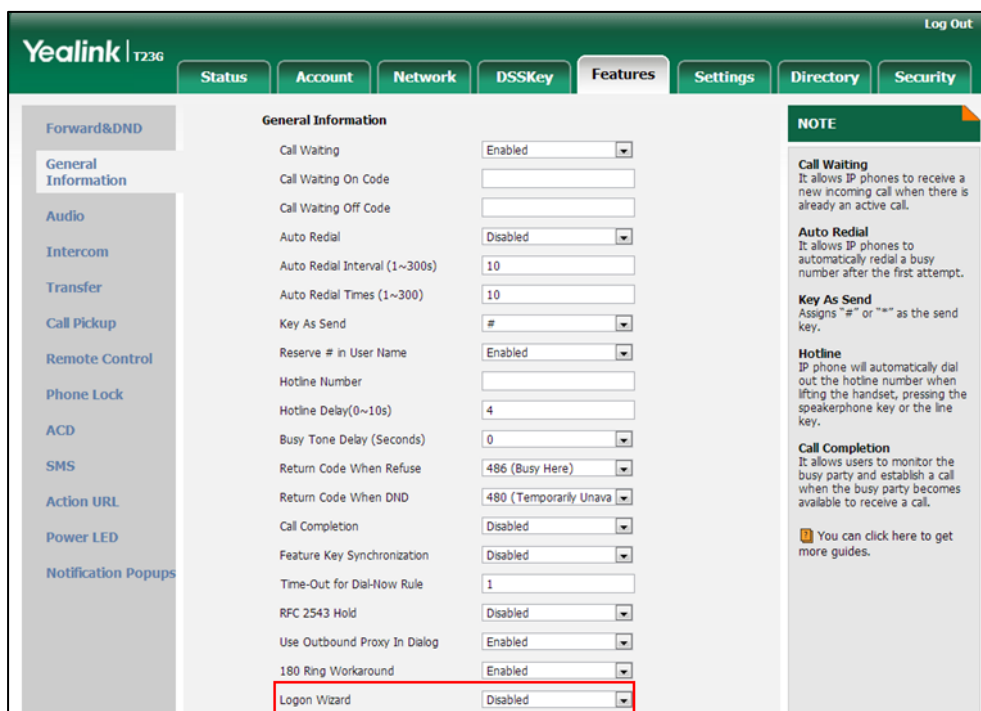

- Click **Confirm** to accept the change.

Action URL

Action URL allows IP phones to interact with web server applications by sending an HTTP or HTTPS GET request. You can specify a URL that triggers a GET request when a specified event occurs. Action URL can only be triggered by the pre-defined events (e.g., Open DND). The valid URL format is: `http(s)://IP address of the server/help.xml?`

The following table lists the pre-defined events for action URL.

Event	Description
Setup Completed	When the IP phone completes startup.
Registered	When the IP phone successfully registers an account.
Unregistered	When the IP phone logs off the registered account.
Register Failed	When the IP phone fails to register an account.
Off Hook	When the IP phone is off hook.
On Hook	When the IP phone is on hook.
Incoming Call	When the IP phone receives an incoming call.
Outgoing Call	When the IP phone places a call.
Established	When the IP phone establishes a call.

Event	Description
Terminated	When the IP phone terminates a call.
Open DND	When the IP phone enables the DND mode.
Close DND	When the IP phone disables the DND mode.
Open Always Forward	When the IP phone enables the always forward.
Close Always Forward	When the IP phone disables the always forward.
Open Busy Forward	When the IP phone enables the busy forward.
Close Busy Forward	When the IP phone disables the busy forward.
Open NoAnswer Forward	When the IP phone enables the no answer forward.
Close NoAnswer Forward	When the IP phone disables the no answer forward.
Transfer Call	When the IP phone transfers a call.
Blind Transfer	When the IP phone blind transfers a call.
Attended Transfer	When the IP phone performs the semi-attended/attended transfer.
Hold	When the IP phone places a call on hold.
UnHold	When the IP phone resumes a hold call.
Held	When a call of the IP phone is held.
UnHeld	When a held call is resumed.
Mute	When the IP phone mutes a call.
UnMute	When the IP phone un-mutes a call.
Missed Call	When the IP phone misses a call.
IP Changed	When the IP address of the IP phone changes.
Idle To Busy	When the state of the IP phone changes from idle to busy.
Busy To Idle	When the state of phone changes from busy to idle.
Reject Incoming Call	When the IP phone rejects an incoming call.
Answer New-In Call	When the IP phone answers a new call.
Transfer Failed	When the IP phone fails to transfer a call.
Transfer Finished	When the IP phone completes to transfer a call.
Forward Incoming Call	When the IP phone forwards an incoming call.
Autop Finish	When the IP phone completes auto provisioning via power on.
Open Call Waiting	When the IP phone enables the call waiting.

Event	Description
Close Call Waiting	When the IP phone disables the call waiting.
Headset	When the IP phone presses the HEADSET key.
Handfree	When the IP phone presses the Speakerphone key.
Cancel Call Out	When the IP phone cancels an outgoing call in the ring-back state.
Remote Busy	When an outgoing call is rejected.
Call Remote Canceled	When the remote party cancels the outgoing call in the ringing state.

An HTTP or HTTPS GET request may contain variable name and variable value, separated by “=”. Each variable value starts with \$ in the query part of the URL. The valid URL format is: `http(s)://IP address of server/help.xml?variable name=$variable value`. Variable name can be custom by users, while the variable value is pre-defined. For example, a URL “`http://192.168.1.10/help.xml?mac=$mac`” is specified for the event Mute, \$mac will be dynamically replaced with the MAC address of the IP phone when the IP phone mutes a call.

The following table lists pre-defined variable values.

Variable Value	Description
\$mac	The MAC address of the IP phone.
\$ip	The IP address of the IP phone.
\$model	The IP phone model.
\$firmware	The firmware version of the IP phone.
\$active_url	The SIP URI of the current account when the IP phone places a call, receives an incoming call or establishes a call.
\$active_user	The user part of the SIP URI for the current account when the IP phone places a call, receives an incoming call or establishes a call.
\$active_host	The host part of the SIP URI for the current account when the IP phone places a call, receives an incoming call or establishes a call.
\$local	The SIP URI of the caller when the IP phone places a call. The SIP URI of the callee when the IP phone receives an incoming call.
\$remote	The SIP URI of the callee when the IP phone places a

Variable Value	Description
	call. The SIP URI of the caller when the IP phone receives an incoming call.
\$display_local	The display name of the caller when the IP phone places a call. The display name of the callee when the IP phone receives an incoming call.
\$display_remote	The display name of the callee when the IP phone places a call. The display name of the caller when the IP phone receives an incoming call.
\$call_id	The call-id of the active call.
\$callerID	The display name of the caller when the IP phone receives an incoming call.
\$calledNumber	The phone number of the callee when the IP phone places a call.

Procedure

Action URL can be configured using the configuration files or locally.

Configuration File	<y0000000000xx>.cfg	Configure action URL. Parameters: action_url.setup_completed action_url.registered action_url.unregistered action_url.register_failed action_url.off_hook action_url.on_hook action_url.incoming_call action_url.outgoing_call action_url.call_established action_url.dnd_on action_url.dnd_off action_url.always_fwd_on action_url.always_fwd_off action_url.busy_fwd_on action_url.busy_fwd_off
---------------------------	---------------------	--

		<p> action_url.no_answer_fwd_on action_url.no_answer_fwd_off action_url.transfer_call action_url.blind_transfer_call action_url.attended_transfer_call action_url.hold action_url.unhold action_url.held action_url.unheld action_url.mute action_url.unmute action_url.missed_call action_url.call_terminated action_url.busy_to_idle action_url.idle_to_busy action_url.ip_change action_url.forward_incoming_call action_url.reject_incoming_call action_url.answer_new_incoming_c all action_url.transfer_finished action_url.transfer_failed action_url.setup_autop_finish action_url.call_waiting_on action_url.call_waiting_off action_url.headset action_url.handfree action_url.cancel_callout action_url.remote_busy action_url.call_remote_canceled </p>
<p>Local</p>	<p>Web User Interface</p>	<p>Configure action URL.</p> <p>Navigate to:</p> <p>http://<phoneIPAddress>/servlet?p =features-actionurl&q=load</p>

Details of Configuration Parameters:

Parameters	Permitted Values	Default
action_url.setup_completed	URL within 511 characters	Blank
<p>Description: Configures the action URL the IP phone sends after startup. The value format is: http(s)://IP address of server/help.xml? variable name=variable value.</p> <p>Valid variable values are:</p> <ul style="list-style-type: none"> • \$mac • \$ip • \$model • \$firmware • \$active_url • \$active_user • \$active_host • \$local • \$remote • \$display_local • \$display_remote • \$call_id • \$callerID • \$calledNumber <p>Example: action_url.setup_completed = http://192.168.0.20/help.xml?IP=\$ip</p> <p>Web User Interface: Features->Action URL->Setup Completed</p> <p>Phone User Interface: None</p>		
action_url.registered	URL within 511 characters	Blank
<p>Description: Configures the action URL the IP phone sends after an account is registered.</p> <p>Example: action_url.registered = http://192.168.0.20/help.xml?IP=\$ip</p>		

Parameters	Permitted Values	Default
<p>Web User Interface: Features->Action URL->Registered</p> <p>Phone User Interface: None</p>		
action_url.unregistered	URL within 511 characters	Blank
<p>Description: Configures the action URL the IP phone sends after an account is unregistered.</p> <p>Example: action_url.unregistered = http://192.168.0.20/help.xml?IP=\$ip</p> <p>Web User Interface: Features->Action URL->Unregistered</p> <p>Phone User Interface: None</p>		
action_url.register_failed	URL within 511 characters	Blank
<p>Description: Configures the action URL the IP phone sends after a register failed.</p> <p>Example: action_url.register_failed = http://192.168.0.20/help.xml?IP=\$ip</p> <p>Web User Interface: Features->Action URL->Register Failed</p> <p>Phone User Interface: None</p>		
action_url.off_hook	URL within 511 characters	Blank
<p>Description: Configures the action URL the IP phone sends when off hook.</p> <p>Example: action_url.off_hook = http://192.168.0.20/help.xml?IP=\$ip</p> <p>Web User Interface: Features->Action URL->Off Hook</p>		

Parameters	Permitted Values	Default
Phone User Interface: None		
action_url.on_hook	URL within 511 characters	Blank
Description: Configures the action URL the IP phone sends when on hook. Example: action_url.on_hook = http://192.168.0.20/help.xml?IP=\$ip Web User Interface: Features->Action URL->On Hook Phone User Interface: None		
action_url.incoming_call	URL within 511 characters	Blank
Description: Configures the action URL the IP phone sends when receiving an incoming call. Example: action_url.incoming_call = http://192.168.0.20/help.xml?IP=\$ip Web User Interface: Features->Action URL->Incoming Call Phone User Interface: None		
action_url.outgoing_call	URL within 511 characters	Blank
Description: Configures the action URL the IP phone sends when placing a call. Example: action_url.outgoing_call = http://192.168.0.20/help.xml?IP=\$ip Web User Interface: Features->Action URL->Outgoing Call Phone User Interface: None		

Parameters	Permitted Values	Default
action_url.call_established	URL within 511 characters	Blank
<p>Description: Configures the action URL the IP phone sends when establishing a call.</p> <p>Example: action_url.call_established = http://192.168.0.20/help.xml?IP=\$ip</p> <p>Web User Interface: Features->Action URL->Established</p> <p>Phone User Interface: None</p>		
action_url.dnd_on	URL within 511 characters	Blank
<p>Description: Configures the action URL the IP phone sends when DND feature is enabled.</p> <p>Example: action_url.dnd_on = http://192.168.0.20/help.xml?IP=\$ip</p> <p>Web User Interface: Features->Action URL->Open DND</p> <p>Phone User Interface: None</p>		
action_url.dnd_off	URL within 511 characters	Blank
<p>Description: Configures the action URL the IP phone sends when DND feature is disabled.</p> <p>Example: action_url.dnd_off = http://192.168.0.20/help.xml?IP=\$ip</p> <p>Web User Interface: Features->Action URL->Close DND</p> <p>Phone User Interface: None</p>		
action_url.always_fwd_on	URL within 511 characters	Blank

Parameters	Permitted Values	Default
<p>Description: Configures the action URL the IP phone sends when always forward feature is enabled.</p> <p>Example: action_url.always_fwd_on = http://192.168.0.20/help.xml?IP=\$ip</p> <p>Web User Interface: Features->Action URL->Open Always Forward</p> <p>Phone User Interface: None</p>		
action_url.always_fwd_off	URL within 511 characters	Blank
<p>Description: Configures the action URL the IP phone sends when always forward feature is disabled.</p> <p>Example: action_url.always_fwd_off = http://192.168.0.20/help.xml?IP=\$ip</p> <p>Web User Interface: Features->Action URL->Close Always Forward</p> <p>Phone User Interface: None</p>		
action_url.busy_fwd_on	URL within 511 characters	Blank
<p>Description: Configures the action URL the IP phone sends when busy forward feature is enabled.</p> <p>Example: action_url.busy_fwd_on = http://192.168.0.20/help.xml?IP=\$ip</p> <p>Web User Interface: Features->Action URL->Open Busy Forward</p> <p>Phone User Interface: None</p>		
action_url.busy_fwd_off	URL within 511 characters	Blank

Parameters	Permitted Values	Default
<p>Description: Configures the action URL the IP phone sends when busy forward feature is disabled.</p> <p>Example: action_url.busy_fwd_off = http://192.168.0.20/help.xml?IP=\$ip</p> <p>Web User Interface: Features->Action URL->Close Busy Forward</p> <p>Phone User Interface: None</p>		
action_url.no_answer_fwd_on	URL within 511 characters	Blank
<p>Description: Configures the action URL the IP phone sends when no answer forward feature is enabled.</p> <p>Example: action_url.no_answer_fwd_on = http://192.168.0.20/help.xml?IP=\$ip</p> <p>Web User Interface: Features->Action URL->Open NoAnswer Forward</p> <p>Phone User Interface: None</p>		
action_url.no_answer_fwd_off	URL within 511 characters	Blank
<p>Description: Configures the action URL the IP phone sends when no answer forward feature is disabled.</p> <p>Example: action_url.no_answer_fwd_off = http://192.168.0.20/help.xml?IP=\$ip</p> <p>Web User Interface: Features->Action URL->Close NoAnswer Forward</p> <p>Phone User Interface: None</p>		
action_url.transfer_call	URL within 511 characters	Blank

Parameters	Permitted Values	Default
<p>Description: Configures the action URL the IP phone sends when performing a transfer.</p> <p>Example: action_url.transfer_call = http://192.168.0.20/help.xml?IP=\$ip</p> <p>Web User Interface: Features->Action URL->Transfer Call</p> <p>Phone User Interface: None</p>		
action_url.blind_transfer_call	URL within 511 characters	Blank
<p>Description: Configures the action URL the IP phone sends when performing a blind transfer.</p> <p>Example: action_url.blind_transfer_call = http://192.168.0.20/help.xml?IP=\$ip</p> <p>Web User Interface: Features->Action URL->Blind Transfer</p> <p>Phone User Interface: None</p>		
action_url.attended_transfer_call	URL within 511 characters	Blank
<p>Description: Configures the action URL the IP phone sends when performing an attended/semi-attended transfer.</p> <p>Example: action_url.attended_transfer_call = http://192.168.0.20/help.xml?IP=\$ip</p> <p>Web User Interface: Features->Action URL->Attended Transfer</p> <p>Phone User Interface: None</p>		
action_url.hold	URL within 511 characters	Blank
<p>Description: Configures the action URL the IP phone sends when placing a call on hold.</p>		

Parameters	Permitted Values	Default
<p>Example: action_url.hold = http://192.168.0.20/help.xml?IP=\$ip</p> <p>Web User Interface: Features->Action URL->Hold</p> <p>Phone User Interface: None</p>		
action_url.unhold	URL within 511 characters	Blank
<p>Description: Configures the action URL the IP phone sends when resuming a hold call.</p> <p>Example: action_url.unhold = http://192.168.0.20/help.xml?IP=\$ip</p> <p>Web User Interface: Features->Action URL->UnHold</p> <p>Phone User Interface: None</p>		
action_url.held	URL within 511 characters	Blank
<p>Description: Configures the action URL the IP phone sends when a call is held.</p> <p>Example: action_url.held = http://192.168.0.20/help.xml?IP=\$ip</p> <p>Web User Interface: None</p> <p>Phone User Interface: None</p>		
action_url.unheld	URL within 511 characters	Blank
<p>Description: Configures the action URL the IP phone sends when a call being held is resumed.</p> <p>Example: action_url.unheld = http://192.168.0.20/help.xml?IP=\$ip</p> <p>Web User Interface:</p>		

Parameters	Permitted Values	Default
None Phone User Interface: None		
action_url.mute	URL within 511 characters	Blank
Description: Configures the action URL the IP phone sends when muting a call. Example: action_url.mute = http://192.168.0.20/help.xml?IP=\$ip Web User Interface: Features->Action URL->Mute Phone User Interface: None		
action_url.unmute	URL within 511 characters	Blank
Description: Configures the action URL the IP phone sends when un-muting a call. Example: action_url.unmute = http://192.168.0.20/help.xml?IP=\$ip Web User Interface: Features->Action URL->UnMute Phone User Interface: None		
action_url.missed_call	URL within 511 characters	Blank
Description: Configures the action URL the IP phone sends when missing a call. Example: action_url.missed_call = http://192.168.0.20/help.xml?IP=\$ip Web User Interface: Features->Action URL->Missed Call Phone User Interface: None		

Parameters	Permitted Values	Default
action_url.call_terminated	URL within 511 characters	Blank
<p>Description: Configures the action URL the IP phone sends when terminating a call.</p> <p>Example: action_url.call_terminated = http://192.168.0.20/help.xml?IP=\$ip</p> <p>Web User Interface: Features->Action URL->Terminated</p> <p>Phone User Interface: None</p>		
action_url.busy_to_idle	URL within 511 characters	Blank
<p>Description: Configures the action URL the IP phone sends when changing the state of the IP phone from busy to idle.</p> <p>Example: action_url.busy_to_idle = http://192.168.0.20/help.xml?IP=\$ip</p> <p>Web User Interface: Features->Action URL->Busy To Idle</p> <p>Phone User Interface: None</p>		
action_url.idle_to_busy	URL within 511 characters	Blank
<p>Description: Configures the action URL the IP phone sends when changing the state of the IP phone from idle to busy.</p> <p>Example: action_url.idle_to_busy = http://192.168.0.20/help.xml?IP=\$ip</p> <p>Web User Interface: Features->Action URL->Idle To Busy</p> <p>Phone User Interface: None</p>		

Parameters	Permitted Values	Default
action_url.ip_change	URL within 511 characters	Blank
<p>Description: Configures the action URL the IP phone sends when changing the IP address of the IP phone.</p> <p>Example: action_url.ip_change = http://192.168.0.20/help.xml?IP=\$ip</p> <p>Web User Interface: Features->Action URL->IP Changed</p> <p>Phone User Interface: None</p>		
action_url.forward_incoming_call	URL within 511 characters	Blank
<p>Description: Configures the action URL the IP phone sends when forwarding an incoming call.</p> <p>Example: action_url.forward_incoming_call = http://192.168.0.20/help.xml?IP=\$ip</p> <p>Web User Interface: Features->Action URL->Forward Incoming Call</p> <p>Phone User Interface: None</p>		
action_url.reject_incoming_call	URL within 511 characters	Blank
<p>Description: Configures the action URL the IP phone sends when rejecting an incoming call.</p> <p>Example: action_url.reject_incoming_call = http://192.168.0.20/help.xml?IP=\$ip</p> <p>Web User Interface: Features->Action URL->Reject Incoming Call</p> <p>Phone User Interface: None</p>		

Parameters	Permitted Values	Default
action_url.answer_new_incoming_call	URL within 511 characters	Blank
<p>Description: Configures the action URL the IP phone sends when answering a new incoming call.</p> <p>Example: action_url.answer_new_incoming_call = http://192.168.0.20/help.xml?IP=\$ip</p> <p>Web User Interface: Features->Action URL->Answer New-In Call</p> <p>Phone User Interface: None</p>		
action_url.transfer_finished	URL within 511 characters	Blank
<p>Description: Configures the action URL the IP phone sends when completing a call transfer.</p> <p>Example: action_url.transfer_finished = http://192.168.0.20/help.xml?IP=\$ip</p> <p>Web User Interface: Features->Action URL->Transfer Finished</p> <p>Phone User Interface: None</p>		
action_url.transfer_failed	URL within 511 characters	Blank
<p>Description: Configures the action URL the IP phone sends when failing to transfer a call.</p> <p>Example: action_url.transfer_failed = http://192.168.0.20/help.xml?IP=\$ip</p> <p>Web User Interface: Features->Action URL->Transfer Failed</p> <p>Phone User Interface: None</p>		
action_url.setup_autop_finish	URL within 511 characters	Blank

Parameters	Permitted Values	Default
<p>Description: Configures the action URL the IP phone sends when completing auto provisioning via power on.</p> <p>Example: action_url.setup_autop_finish = http://192.168.0.20/help.xml?IP=\$ip</p> <p>Web User Interface: Features->Action URL->Autop Finish</p> <p>Phone User Interface: None</p>		
action_url.call_waiting_on	URL within 511 characters	Blank
<p>Description: Configures the action URL the IP phone sends when call waiting feature is enabled.</p> <p>Example: action_url.call_waiting_on = http://192.168.0.20/help.xml?IP=\$ip</p> <p>Web User Interface: Features->Action URL->Open Call Waiting</p> <p>Phone User Interface: None</p>		
action_url.call_waiting_off	URL within 511 characters	Blank
<p>Description: Configures the action URL the IP phone sends when call waiting feature is disabled.</p> <p>Example: action_url.call_waiting_off = http://192.168.0.20/help.xml?IP=\$ip</p> <p>Web User Interface: Features->Action URL->Close Call Waiting</p> <p>Phone User Interface: None</p>		
action_url.headset	URL within 511 characters	Blank
<p>Description:</p>		

Parameters	Permitted Values	Default
<p>Configures the action URL the IP phone sends when pressing the HEADSET key.</p> <p>Example: <code>action_url.headset = http://192.168.0.20/help.xml?IP=\$ip</code></p> <p>Web User Interface: Features->Action URL->Headset</p> <p>Phone User Interface: None</p>		
action_url.handfree	URL within 511 characters	Blank
<p>Description: Configures the action URL the IP phone sends when pressing the Speakerphone key.</p> <p>Example: <code>action_url.handfree = http://192.168.0.20/help.xml?IP=\$ip</code></p> <p>Web User Interface: Features->Action URL->Handfree</p> <p>Phone User Interface: None</p>		
action_url.cancel_callout	URL within 511 characters	Blank
<p>Description: Configures the action URL the IP phone sends when cancels the outgoing call in the ring-back state.</p> <p>Example: <code>action_url.cancel_callout = http://192.168.0.20/help.xml?IP=\$ip</code></p> <p>Web User Interface: Features->Action URL->Cancel Call Out</p> <p>Phone User Interface: None</p>		
action_url.remote_busy	URL within 511 characters	Blank

Parameters	Permitted Values	Default
<p>Description: Configures the action URL the IP phone sends when the outgoing call is rejected.</p> <p>Example: action_url.remote_busy = http://192.168.0.20/help.xml?IP=\$ip</p> <p>Web User Interface: Features->Action URL->Remote Busy</p> <p>Phone User Interface: None</p>		
action_url.call_remote_canceled	URL within 511 characters	Blank
<p>Description: Configures the action URL the IP phone sends when the remote party cancels the outgoing call in the ringing state.</p> <p>Example: action_url.call_remote_canceled = http://192.168.0.20/help.xml?IP=\$ip</p> <p>Web User Interface: Features->Action URL->Call Remote Canceled</p> <p>Phone User Interface: None</p>		

To configure action URL via web user interface:

1. Click on **Features->Action URL**.

2. Enter the action URLs in the corresponding fields.

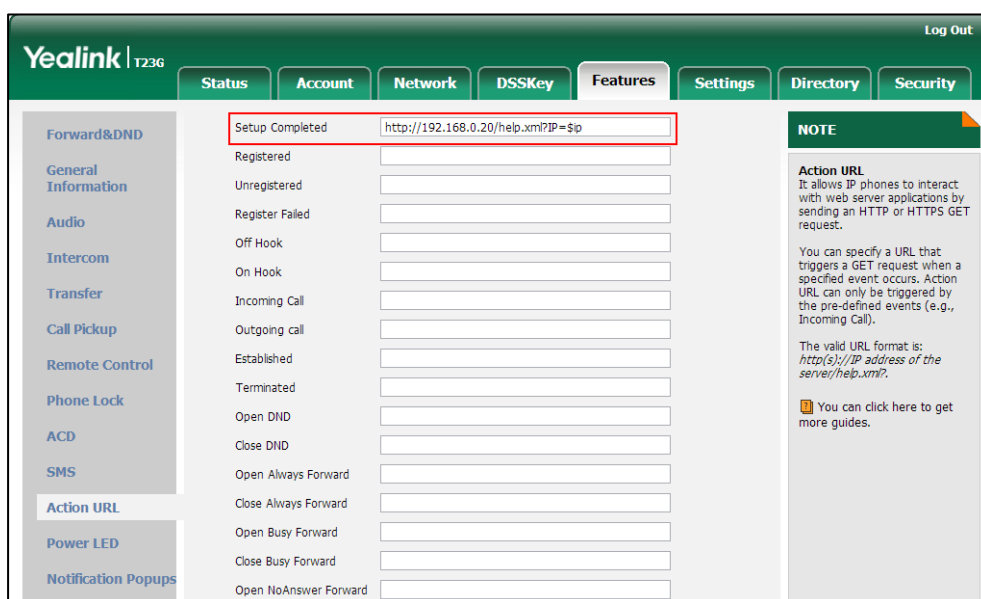

3. Click **Confirm** to accept the change.

Action URI

HTTP/HTTPS GET Request

Opposite to action URL, action URI allows IP phones to interact with web server application by receiving and handling an HTTP or HTTPS GET request. When receiving a GET request, the IP phone will perform the specified action and respond with a 200 OK message. A GET request may contain variable named as “key” and variable value, which are separated by “=”. The valid URI format is: http(s)://phone IP address/servlet?key=variable value. For example: http://10.3.20.10/servlet?key=OK.

SIP Notify Message

In addition, Yealink IP phones support performing the specified action immediately by accepting a SIP NOTIFY message with the “Event: ACTION-URI” header from a SIP proxy server. The message body of the SIP NOTIFY message may contain variable named as “key” and variable value, which are separated by “=”.

This method is especially useful for users always working in the small office/home office where a secure firewall may prevent the HTTP or HTTPS GET request from the external network.

Note

If you want to only accept the SIP NOTIFY message from your SIP server and outbound proxy server, you have to enable the Accept SIP Trust Server Only feature. For more information, refer to [Accept SIP Trust Server Only](#) on page 240.

Example of a SIP Notify with the variable value (OK):

Message Header

NOTIFY sip:3583@10.2.40.10:5062 SIP/2.0
Via: SIP/2.0/UDP 10.2.40.27:5063;branch=z9hG4bK4163876675
From: <sip:3586@10.3.5.199>;tag=2900480538
To: "3583" <sip:3583@10.3.5.199>;tag=490600926
Call-ID: 2923387519@10.2.40.10
CSeq: 4 NOTIFY
Contact: <sip:3586@10.2.40.27:5063>
Max-Forwards: 70
User-Agent: Yealink SIP-T23G
Event: ACTION-URI
Content-Type: message/sipfrag
Content-Length: 6

Message Body

key=OK

The following table lists pre-defined variable values:

Variable Value	Phone Action
OK	Press the OK/v key.
ENTER	Press the Enter soft key.
SPEAKER	Press the Speakerphone key.
F_TRANSFER	Transfers a call to another party.
VOLUME_UP	Increase the volume.
VOLUME_DOWN	Decrease the volume.
MUTE	Mute a call.
F_HOLD	Place an active call on hold.
F_CONFERENCE	Press the Conf soft key.
X	Cancel actions or reject incoming calls or mute or un-mute calls.
0-9*/POUND	Press the keypad (0-9, * or #).
L1-LX	Press the line keys (for SIP-T48G, X=29, for SIP-T46G/T29G, X=27, for SIP-T42G/T41P, X=15, for SIP-T27P, X=21, for SIP-T23P/G, X=3, for SIP-T21(P) E2, X=2).
F1-F4	Press the soft keys.
MSG	Press the MESSAGE key.
HEADSET	Press the HEADSET key.
RD	Press the RD key.
UP/DOWN/LEFT/RIGHT	Press the navigation keys.
Reboot	Reboot the phone.
AutoP	Perform auto provisioning.
DNDOn	Activate the DND mode.
DNDOff	Deactivate the DND mode.
number=xxx&outgoing_uri=y	Place a call to xxx from SIP URI y. Example: http://10.3.20.10/servlet?key=number=1234 &outgoing_uri=1006@10.3.5.199 (1234 means the number you dial out; 1006@10.3.5.199 means the SIP URL you dial from.)

Variable Value	Phone Action
OFFHOOK	Pick up the handset.
ONHOOK	Hang up the handset.
ANSWER	Answer a call.
Reset	Reset a phone.
ATrans=xxx	Perform a semi-attended/attended transfer to xxx.
BTrans=xxx	Perform a blind transfer to xxx.
CALLEND	End a call.
phonecfg=get[&accounts=x][&dnd=x][&fw=x]	<p>Get firmware version, registration, DND or forward configuration information.</p> <p>The valid value of "x" is 0 or 1, 0 means you do not need to get configuration information. 1 means you want to get configuration information.</p> <p>Note: The valid URI is: http(s)://phone IP address/servlet?phonecfg=get[&accounts=x][&dnd=x][&fw=x]</p> <p>Example:</p> <p>http://10.3.20.10/servlet?phonecfg=get[&accounts=1][&dnd=0][&fw=1]</p>

Note

The variable value is not applicable to all events. For example, the variable value "MUTE" is only applicable when the IP phone is during a call.

When authentication is required, you must enter "p=login&q=login&username=xxx&pwd=yyy&jumpto=URI&" before the variable "key". xxx refers to the login user name and yyy refers to the login password.

Configuring Trusted IP Address for Action URI

For security reasons, IP phones do not receive and handle HTTP/HTTPS GET requests by default. You need to specify the trusted IP address for action URI. When the IP phone receives a GET request from the trusted IP address for the first time, the LCD screen prompts the message "Allow Remote Control?". You can specify one or more trusted IP addresses on the IP phone, or configure the IP phone to receive and handle the URI from any IP address.

You can use action URI feature to capture the phone's current screen. For more information, refer to [Capturing the Current Screen of the Phone](#) on page 532.

Procedure

Specify the trusted IP address for action URI using the configuration files or locally.

Configuration File	<y0000000000xx>.cfg	<p>Configure the IP phone to receive the action URI requests.</p> <p>Parameter: features.action_uri.enable</p> <p>Specify the trusted IP address(es) for sending the action URI to the IP phone.</p> <p>Parameter: features.action_uri_limit_ip</p>
Local	Web User Interface	<p>Specify the trusted IP address(es) for sending the action URI to the IP phone.</p> <p>Navigate to: http://<phoneIPAddress>/servlet?ρ=features-remotecontrl&q=load</p>

Details of the Configuration Parameter:

Parameter	Permitted Values	Default
features.action_uri.enable	0 or 1	0
<p>Description: Enables or disables the IP phone to receive the action URI requests.</p> <p>0-Disabled 1-Enabled</p> <p>Web User Interface: None</p> <p>Phone User Interface: None</p>		
features.action_uri_limit_ip	IP address or any	Blank
<p>Description: Configures the IP address of the server from which the IP phone receives the action URI requests.</p> <p>For discontinuous IP addresses, multiple IP addresses are separated by commas.</p>		

Parameter	Permitted Values	Default
<p>For continuous IP addresses, the format likes *.*.* and the "*" stands for the values 0~255.</p> <p>For example: 10.10.*.* stands for the IP addresses that range from 10.10.0.0 to 10.10.255.255.</p> <p>If left blank, the IP phone will reject any HTTP GET request.</p> <p>If it is set to "any", the IP phone will accept and handle HTTP GET requests from any IP address.</p> <p>Example:</p> <p>features.action_uri_limit_ip = any</p> <p>Note: It works only if the value of the parameter "features.action_uri.enable" is set to 1 (Enabled).</p> <p>Web User Interface:</p> <p>Features->Remote Control->Action URI allow IP List</p> <p>Phone User Interface:</p> <p>None</p>		

To configure the trusted IP address(es) for action URI via web user interface:

1. Click on **Features->Remote Control**.
2. Enter the IP address or any in the **Action URI allow IP List** field.

Multiple IP addresses are separated by commas. If you enter "any" in this field, the IP phone can receive and handle GET requests from any IP address. If you leave the field blank, the IP phone cannot receive or handle any HTTP GET request.

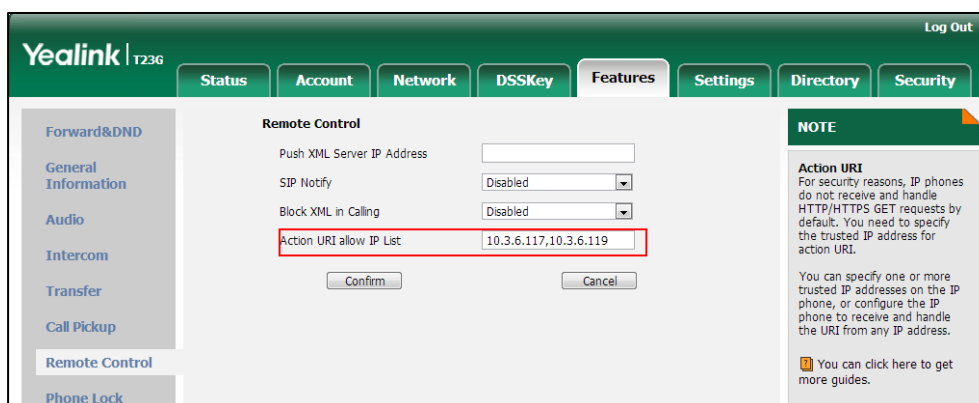

3. Click **Confirm** to accept the change.

Capturing the Current Screen of the Phone

You can capture the screen display of the IP phone using the action URI. IP phones support handling an HTTP or HTTPS GET request. The URI format is

`http(s)://<phoneIPAddress>/screenshot`. The captured picture can be saved as a BMP or JPEG file.

You can also use the URI "`http(s)://<phoneIPAddress>/screenshot/download`" to capture the screen display first, and then download the image (which is saved as a JPG file and named with the phone model and the capture time) to the local system. Before capturing the phone's current screen, ensure that the IP address of the computer is included in the trusted IP address for Action URI on the phone.

When you capture the screen display, the IP phone may prompt you to enter the user name and password of the administrator if web browser does not remember the user name and password for web user interface login.

Note

IP phones also support capturing the screen display using the old URI "`http://<phoneIPAddress>/servlet?command=screenshot`".

To capture the current screen of the phone:

1. Enter request URI (e.g., `http://10.3.20.8/screenshot`) in the browser's address bar and press the Enter key on the keyboard.
2. Do one of the following:
 - If it is the first time you capture the phone's current screen using the computer, the browser will display "Remote control forbidden", and the LCD screen will prompt the message "Allow remote control?".

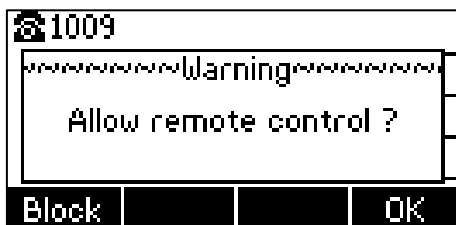

Press **OK** soft key on the phone to allow remote control. The phone will return to the previous screen.

Refresh the web page.

The browser will display an image showing the phone's current screen. You can save the image to your local system.

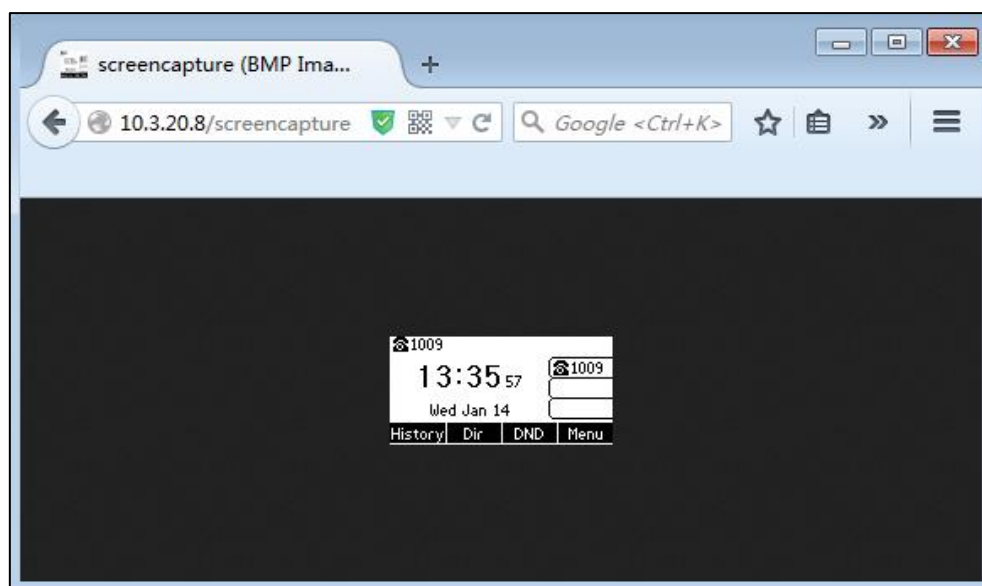

- Else, the browser will display an image showing the phone's current screen directly. You can save the image to your local system.

Note

Frequent capture may affect the phone performance. Yealink recommend you to capture the phone screen display within a minimum interval of 4 seconds.

Server Redundancy

Server redundancy is often required in VoIP deployments to ensure continuity of phone service, for events where the server needs to be taken offline for maintenance, the server fails, or the connection between the IP phone and the server fails.

Two types of redundancy are possible. In some cases, a combination of the two may be deployed:

- **Failover:** In this mode, the full phone system functionality is preserved by having a second equivalent capability call server take over from the one that has gone down/off-line. This mode of operation should be done using the DNS mechanism from the primary to the secondary server.
- **Fallback:** In this mode, a second less featured call server with SIP capability takes over call control to provide basic calling capability, but without some advanced features (for example, shared line, call recording and MWI) offered by the working server. IP phones support configuration of two servers per SIP registration for fallback purpose.

Phone Configuration for Redundancy Implementation

To assist in explaining the redundancy behavior, an illustrative example of how an IP phone may be configured is shown as below. In the example, server redundancy for fallback and failover purposes is deployed. Two separate servers (a working server and a fallback server) are configured for per line registration.

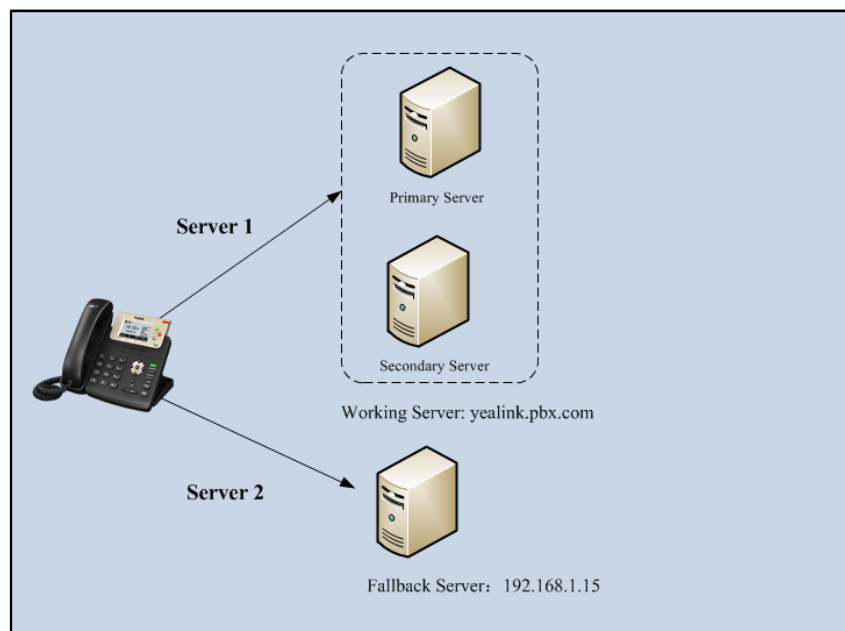

Working Server: Server 1 is configured with the domain name of the working server. For example: yealink.pbx.com. DNS mechanism is used such that the working server is resolved to multiple servers for failover purpose. The working server is deployed in redundant pairs, designated as primary and secondary servers. The primary server has the highest priority server in a cluster of servers resolved by the DNS server. The secondary server backs up a primary server when the primary server fails and offers the same functionality as the primary server.

Fallback Server: Server 2 is configured with the IP address of the fallback server. For example, 192.168.1.15. A fallback server offers less functionality than the working server.

Phone Registration

Registration method of the failover mode:

The IP phone must always register to the primary server first except in failover conditions. If this is unsuccessful, the phone will re-register as many times as configured until the registration is successful. When the primary server registration is unavailable, the secondary server will serve as the working server.

Registration methods of the fallback mode include:

- **Concurrent registration (default):** The IP phone registers to two SIP servers (working server and fallback server) at the same time. In a failure situation, a fallback server can take over the basic calling capability, but without some advanced features (for

example, shared lines, call recording and MWI) offered by the working server. It is not applicable to outbound proxy servers

- **Successive registration:** The IP phone only registers to one server at a time. The IP phone first registers to the working server. In a failure situation, the IP phone registers to the fallback server.

For more information on server redundancy, refer to [Server Redundancy on Yealink IP Phones](#).

Procedure

Server redundancy can be configured using the configuration files or locally.

<p>Configuration File</p>	<p><MAC>.cfg</p>	<p>Configure the SIP server redundancy.</p> <p>Parameters:</p> <p>account.X.sip_server.Y.address account.X.sip_server.Y.port account.X.sip_server.Y.expires account.X.sip_server.Y.retry_counts</p> <p>Configure the outbound proxy server redundancy.</p> <p>Parameters:</p> <p>account.X.outbound_proxy_enable account.X.outbound_host account.X.outbound_port account.X.backup_outbound_host account.X.backup_outbound_port</p> <p>Fallback Mode:</p> <p>account.X.fallback.redundancy_type account.X.fallback.timeout account.X.outbound_proxy_fallback_interval</p> <p>Failover Mode:</p> <p>account.X.sip_server.Y.failback_mode account.X.sip_server.Y.failback_timeout account.X.sip_server.Y.register_on_enable</p>
<p>Local</p>	<p>Web User Interface</p>	<p>Configure the server redundancy on the IP phone.</p> <p>Navigate to:</p> <p>http://<phoneIPAddress>/servlet?p=account-register&q=load&acc=0</p>

Details of Configuration Parameters:

Parameters	Permitted Values	Default
account.X.sip_server.Y.address (X ranges from 1 to 16, Y ranges from 1 to 2)	String within 256 characters	Blank
<p>Description: Configures the IP address or domain name of the SIP server Y for account X. X ranges from 1 to 16 (for SIP-T48G/T46G/T29G) X ranges from 1 to 12 (for SIP-T42G) X ranges from 1 to 6 (for SIP-T41P/T27P) X ranges from 1 to 3 (for SIP-T23P/G) X ranges from 1 to 2 (for SIP-T21(P) E2) X is equal to 1 (for SIP-T19(P) E2)</p> <p>Example: account.1.sip_server.1.address = yealink.pbx.com</p> <p>Web User Interface: Account->Register->SIP Server Y->Server Host</p> <p>Phone User Interface: None</p>		
account.X.sip_server.Y.port (X ranges from 1 to 16, Y ranges from 1 to 2)	Integer from 0 to 65535	5060
<p>Description: Configures the port of the SIP server Y for account X. X ranges from 1 to 16 (for SIP-T48G/T46G/T29G) X ranges from 1 to 12 (for SIP-T42G) X ranges from 1 to 6 (for SIP-T41P/T27P) X ranges from 1 to 3 (for SIP-T23P/G) X ranges from 1 to 2 (for SIP-T21(P) E2) X is equal to 1 (for SIP-T19(P) E2)</p> <p>Example: account.1.sip_server.1.port = 5060</p> <p>Web User Interface: Account->Register->SIP Server Y->Port</p> <p>Phone User Interface: None</p>		

Parameters	Permitted Values	Default
account.X.sip_server.Y.expires (X ranges from 1 to 16, Y ranges from 1 to 2)	Integer from 30 to 2147483647	3600
<p>Description: Configures the registration expiration time (in seconds) of the SIP server Y for account X.</p> <p>X ranges from 1 to 16 (for SIP-T48G/T46G/T29G) X ranges from 1 to 12 (for SIP-T42G) X ranges from 1 to 6 (for SIP-T41P/T27P) X ranges from 1 to 3 (for SIP-T23P/G) X ranges from 1 to 2 (for SIP-T21(P) E2) X is equal to 1 (for SIP-T19(P) E2)</p> <p>Example: account.1.sip_server.1.expires = 3600</p> <p>Web User Interface: Account->Register->SIP Server Y->Server Expires</p> <p>Phone User Interface: None</p>		
account.X.sip_server.Y.retry_counts (X ranges from 1 to 16, Y ranges from 1 to 2)	Integer from 0 to 20	3
<p>Description: Configures the retry times for the IP phone to resend requests when the SIP server Y is unavailable or there is no response from the SIP server Y for account X.</p> <p>X ranges from 1 to 16 (for SIP-T48G/T46G/T29G) X ranges from 1 to 12 (for SIP-T42G) X ranges from 1 to 6 (for SIP-T41P/T27P) X ranges from 1 to 3 (for SIP-T23P/G) X ranges from 1 to 2 (for SIP-T21(P) E2) X is equal to 1 (for SIP-T19(P) E2)</p> <p>Web User Interface: Account->Register->SIP Server Y->Server Retry Counts</p> <p>Phone User Interface: None</p>		
account.X.sip_server.Y.register_on_enable (X ranges from 1 to 16, Y ranges from 1 to 2)	0 or 1	0

Parameters	Permitted Values	Default
<p>Description: Enables or disables the IP phone to send registration requests to the secondary server for account X when encountering a failover.</p> <p>0-Disabled 1-Enabled</p> <p>X ranges from 1 to 16 (for SIP-T48G/T46G/T29G) X ranges from 1 to 12 (for SIP-T42G) X ranges from 1 to 6 (for SIP-T41P/T27P) X ranges from 1 to 3 (for SIP-T23P/G) X ranges from 1 to 2 (for SIP-T21(P) E2) X is equal to 1 (for SIP-T19(P) E2)</p> <p>Web User Interface: None</p> <p>Phone User Interface: None</p>		
account.X.outbound_proxy_enable	0 or 1	0
<p>Description: Enables or disables the IP phone to send requests to the outbound proxy server for account X.</p> <p>0-Disabled 1-Enabled</p> <p>X ranges from 1 to 16 (for SIP-T48G/T46G/T29G) X ranges from 1 to 12 (for SIP-T42G) X ranges from 1 to 6 (for SIP-T41P/T27P) X ranges from 1 to 3 (for SIP-T23P/G) X ranges from 1 to 2 (for SIP-T21(P) E2) X is equal to 1 (for SIP-T19(P) E2)</p> <p>Web User Interface: Account->Register->Enable Outbound Proxy Server</p> <p>Phone User Interface: Menu->Settings->Advanced Settings->Accounts->Outbound Status</p>		
account.X.outbound_host	IP address or domain name	Blank

Parameters	Permitted Values	Default
<p>Description: Configures the IP address or domain name of the outbound proxy server 1 for account X. X ranges from 1 to 16 (for SIP-T48G/T46G/T29G) X ranges from 1 to 12 (for SIP-T42G) X ranges from 1 to 6 (for SIP-T41P/T27P) X ranges from 1 to 3 (for SIP-T23P/G) X ranges from 1 to 2 (for SIP-T21(P) E2) X is equal to 1 (for SIP-T19(P) E2)</p> <p>Note: It works only if the value of the parameter "account.X.outbound_proxy_enable" is set to 1 (Enabled).</p> <p>Web User Interface: Account->Register->Outbound Proxy Server 1</p> <p>Phone User Interface: Menu->Settings->Advanced Settings->Accounts->Outbound Proxy1</p>		
account.X.outbound_port	Integer from 0 to 65535	5060
<p>Description: Configures the port of the outbound proxy server 1 for account X. X ranges from 1 to 16 (for SIP-T48G/T46G/T29G) X ranges from 1 to 12 (for SIP-T42G) X ranges from 1 to 6 (for SIP-T41P/T27P) X ranges from 1 to 3 (for SIP-T23P/G) X ranges from 1 to 2 (for SIP-T21(P) E2) X is equal to 1 (for SIP-T19(P) E2)</p> <p>Example: account.1.outbound_port = 5060</p> <p>Note: It works only if the value of the parameter "account.X.outbound_proxy_enable" is set to 1 (Enabled).</p> <p>Web User Interface: Account->Register->Outbound Proxy Server 1->Port</p> <p>Phone User Interface: None</p>		
account.X.backup_outbound_host	IP address or	Blank

Parameters	Permitted Values	Default
	domain name	
<p>Description: Configures the IP address or domain name of the outbound proxy server 2 for account X. X ranges from 1 to 16 (for SIP-T48G/T46G/T29G) X ranges from 1 to 12 (for SIP-T42G) X ranges from 1 to 6 (for SIP-T41P/T27P) X ranges from 1 to 3 (for SIP-T23P/G) X ranges from 1 to 2 (for SIP-T21(P) E2) X is equal to 1 (for SIP-T19(P) E2) Note: It works only if the value of the parameter "account.X.outbound_proxy_enable" is set to 1 (Enabled). Web User Interface: Account->Register->Outbound Proxy Server 2 Phone User Interface: Menu->Settings->Advanced Settings->Accounts->Outbound Proxy2</p>		
account.X.backup_outbound_port	Integer from 0 to 65535	5060
<p>Description: Configures the port of the outbound proxy server 2 for account X. X ranges from 1 to 16 (for SIP-T48G/T46G/T29G) X ranges from 1 to 12 (for SIP-T42G) X ranges from 1 to 6 (for SIP-T41P/T27P) X ranges from 1 to 3 (for SIP-T23P/G) X ranges from 1 to 2 (for SIP-T21(P) E2) X is equal to 1 (for SIP-T19(P) E2) Example: account.1.backup_outbound_port = 5060 Note: It works only if the value of the parameter "account.X.outbound_proxy_enable" is set to 1 (Enabled). Web User Interface: Account->Register->Outbound Proxy Server 2->Port Phone User Interface: None</p>		

Parameters	Permitted Values	Default
account.X.fallback.redundancy_type	0 or 1	0
<p>Description: Configures the registration mode for the IP phone in fallback mode.</p> <p>0-Concurrent Registration 1-Successive Registration</p> <p>X ranges from 1 to 16 (for SIP-T48G/T46G/T29G) X ranges from 1 to 12 (for SIP-T42G) X ranges from 1 to 6 (for SIP-T41P/T27P) X ranges from 1 to 3 (for SIP-T23P/G) X ranges from 1 to 2 (for SIP-T21(P) E2) X is equal to 1 (for SIP-T19(P) E2)</p> <p>Note: The outbound proxy servers only support Successive Registration, so the parameter is not applicable to outbound proxy servers.</p> <p>Web User Interface: None</p> <p>Phone User Interface: None</p>		
account.X.fallback.timeout	Integer from 10 to 2147483647	120
<p>Description: Configures the time interval (in seconds) for the IP phone to detect whether the working server is available by sending the registration request for account X after the fallback server takes over call control.</p> <p>X ranges from 1 to 16 (for SIP-T48G/T46G/T29G) X ranges from 1 to 12 (for SIP-T42G) X ranges from 1 to 6 (for SIP-T41P/T27P) X ranges from 1 to 3 (for SIP-T23P/G) X ranges from 1 to 2 (for SIP-T21(P) E2) X is equal to 1 (for SIP-T19(P) E2)</p> <p>Note: It works only if the value of the parameter "account.X.fallback.redundancy_type" is set to 1 (Successive Registration) and it is not applicable to outbound proxy servers.</p> <p>Web User Interface: None</p>		

Parameters	Permitted Values	Default
Phone User Interface: None		
account.X.outbound_proxy_fallback_interval	Integer from 0 to 65535	3600
Description: Configures the time interval (in seconds) for the IP phone to detect whether the working outbound proxy server is available by sending the registration request after the fallback server takes over call control. X ranges from 1 to 16 (for SIP-T48G/T46G/T29G) X ranges from 1 to 12 (for SIP-T42G) X ranges from 1 to 6 (for SIP-T41P/T27P) X ranges from 1 to 3 (for SIP-T23P/G) X ranges from 1 to 2 (for SIP-T21(P) E2) X is equal to 1 (for SIP-T19(P) E2) Example: account.1.outbound_proxy_fallback_interval = 3600 Note: It is only applicable to outbound proxy servers. Web User Interface: Account->Register->Proxy Fallback Interval Phone User Interface: Menu->Settings->Advanced Settings->Accounts->Proxy Fallback Interval		
account.X.sip_server.Y.failback_mode (X ranges from 1 to 16, Y ranges from 1 to 2)	0, 1, 2 or 3	0
Description: Configures the mode for the IP phone to retry the primary server in failover for account X. 0 -newRequests: all requests are sent to the primary server first, regardless of the last server that was used. 1 -DNSTTL: the IP phone will send requests to the last registered server first. If the time defined by DNSTTL on the registered server expires, the phone will retry to send requests to the primary server. 2 -Registration: the IP phone will send requests to the last registered server first. If the registration expires, the phone will retry to send requests to the primary server. 3 -duration: the IP phone will send requests to the last registered server first. If the time defined by the "account.X.sip_server.Y.failback_timeout" parameter expires,		

Parameters	Permitted Values	Default
<p>the phone will retry to send requests to the primary server.</p> <p>X ranges from 1 to 16 (for SIP-T48G/T46G/T29G)</p> <p>X ranges from 1 to 12 (for SIP-T42G)</p> <p>X ranges from 1 to 6 (for SIP-T41P/T27P)</p> <p>X ranges from 1 to 3 (for SIP-T23P/G)</p> <p>X ranges from 1 to 2 (for SIP-T21(P) E2)</p> <p>X is equal to 1 (for SIP-T19(P) E2)</p> <p>Web User Interface:</p> <p>None</p> <p>Phone User Interface:</p> <p>None</p>		
<p>account.X.sip_server.Y.failback_timeout (X ranges from 1 to 16, Y ranges from 1 to 2)</p>	<p>0, Integer from 60 to 65535</p>	<p>3600</p>
<p>Description:</p> <p>Configures the time (in seconds) for the phone to retry to send requests to the primary server after failing over to the current working server for account X.</p> <p>If you set the parameter to 0, the IP phone will not send requests to the primary server until a failover event occurs with the current working server.</p> <p>If you set the parameter between 1 and 59, the timeout will be 60 seconds.</p> <p>X ranges from 1 to 16 (for SIP-T48G/T46G/T29G)</p> <p>X ranges from 1 to 12 (for SIP-T42G)</p> <p>X ranges from 1 to 6 (for SIP-T41P/T27P)</p> <p>X ranges from 1 to 3 (for SIP-T23P/G)</p> <p>X ranges from 1 to 2 (for SIP-T21(P) E2)</p> <p>X is equal to 1 (for SIP-T19(P) E2)</p> <p>Note: It works only if the value of the parameter "account.X.sip_server.Y.failback_mode" is set to 3 (duration).</p> <p>Web User Interface:</p> <p>None</p> <p>Phone User Interface:</p> <p>None</p>		

To configure server redundancy for fallback purpose via web user interface:

1. Click on **Account->Register**.
2. Select the desired account from the pull-down list of **Account**.

3. Configure registration parameters of the selected account in the corresponding fields.
4. Configure parameters of SIP server 1 and SIP server 2 in the corresponding fields.

The screenshot displays the 'Account' configuration page for 'Account 1' in the Yealink T236 web interface. The page is divided into several sections: 'Register', 'SIP Server 1', 'SIP Server 2', and 'Outbound Proxy Server'. The 'SIP Server 1' and 'SIP Server 2' sections are highlighted with a red box. The 'SIP Server 1' section includes fields for 'Server Host' (192.168.1.14), 'Transport' (UDP), 'Server Expires' (3600), and 'Server Retry Counts' (3). The 'SIP Server 2' section includes fields for 'Server Host' (192.168.1.15), 'Transport' (UDP), 'Server Expires' (3600), and 'Server Retry Counts' (3). Other fields include 'Register Status' (Registered), 'Line Active' (Enabled), 'Label' (4605), 'Display Name' (4605), 'Register Name' (4605), 'User Name' (4605), 'Password' (*****), 'Enable Outbound Proxy Server' (Disabled), 'Outbound Proxy Server 1' and 'Outbound Proxy Server 2' (empty), 'Proxy Falback Interval' (3600), and 'NAT' (Disabled). A 'NOTE' section on the right provides information about 'Account Registration', 'Server Redundancy', and 'NAT Traversal'.

5. If you use outbound proxy servers, do the following:
 - 1) Select **Enabled** from the pull-down list of **Enable Outbound Proxy Server**.

- 2) Configure parameters of outbound proxy server 1 and outbound proxy server 2 in the corresponding fields.

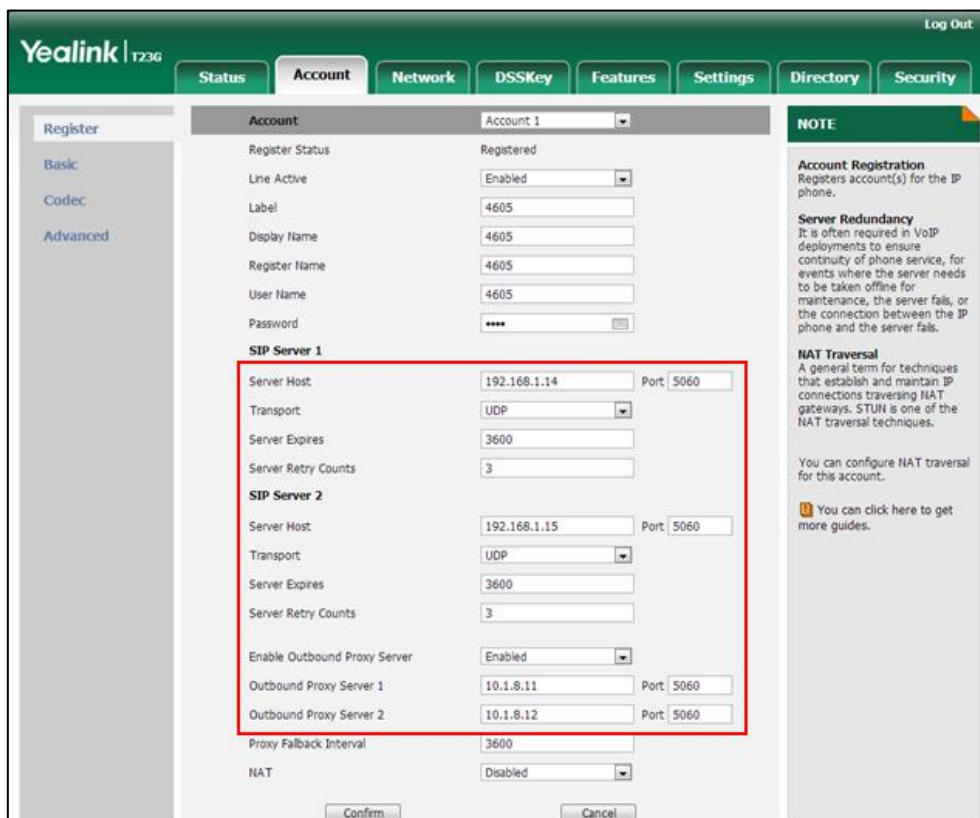

6. Click **Confirm** to accept the change.

To configure server redundancy for failover purpose via web user interface:

1. Click on **Account->Register**.
2. Select the desired account from the pull-down list of **Account**.
3. Configure registration parameters of the selected account in the corresponding fields.
4. Configure parameters of the SIP server 1 or SIP server 2 in the corresponding fields.
You must set the port of SIP server to 0 for NAPTR, SRV and A queries.

5. Select **DNS-NAPTR** from the pull-down list of **Transport**.

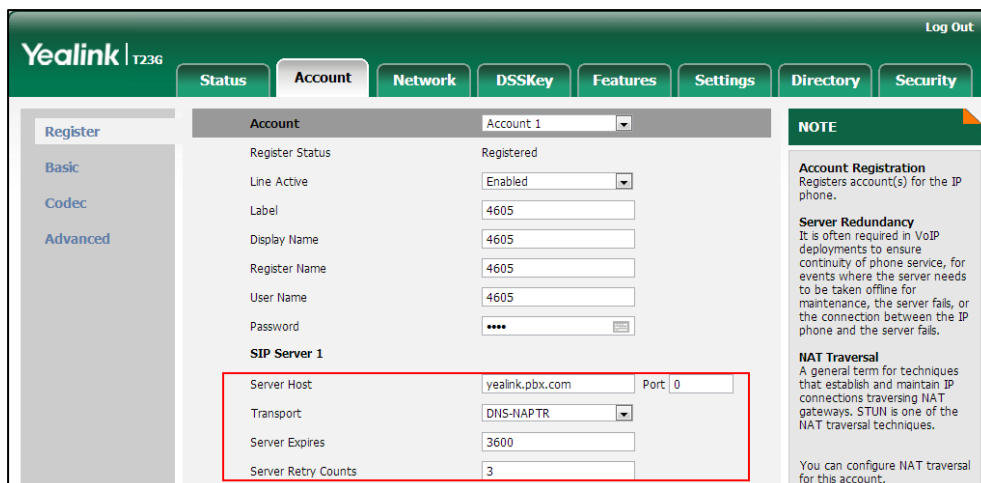

6. If you use outbound proxy servers, do the following:

- 1) Select **Enabled** from the pull-down list of **Enable Outbound Proxy Server**.
- 2) Configure parameters of outbound proxy server 1/2 in the corresponding fields.

You must set the port of outbound proxy server to 0 for NAPTR, SRV and A queries.

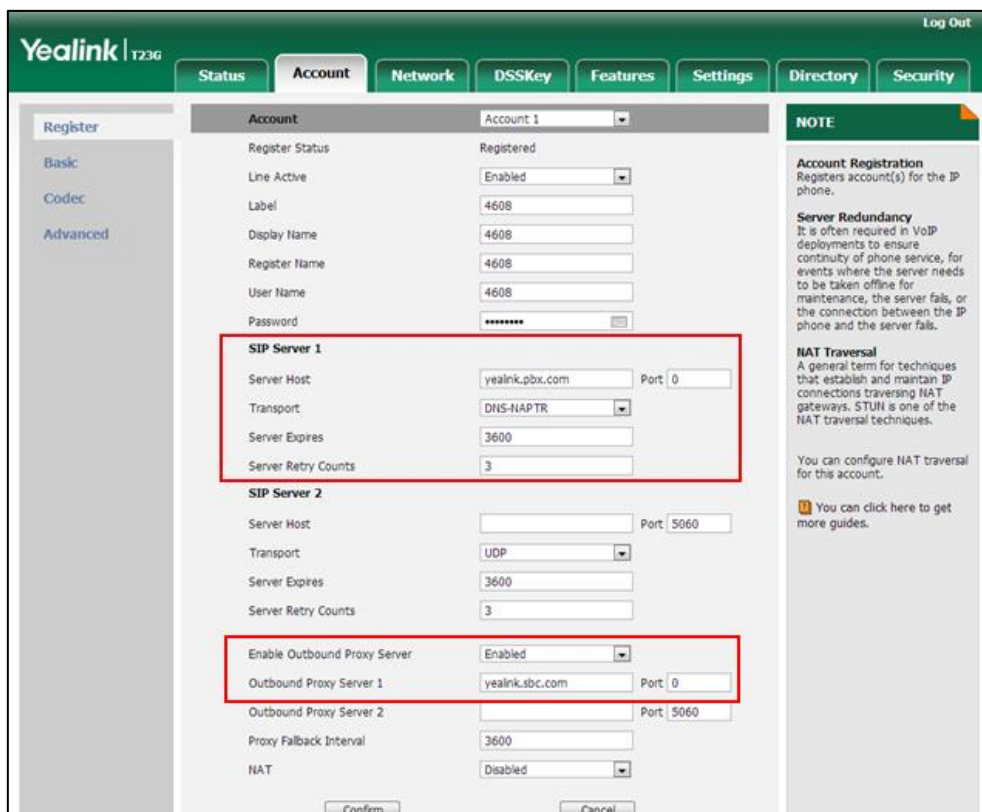

7. Click **Confirm** to accept the change.

Server Domain Name Resolution

If a domain name is configured for a server, the IP address(es) associated with that domain name will be resolved through DNS as specified by RFC 3263. The DNS query involves NAPTR, SRV and A queries, which allows the IP phone to adapt to various deployment environments. The IP phone performs NAPTR query for the NAPTR pointer and transport protocol (UDP, TCP and TLS), the SRV query on the record returned from the NAPTR for the target domain name and the port number, and the A query for the IP addresses.

If an explicit port (except 0) is specified, A query will be performed only. If a server port is set to 0 and the transport type is set to DNS-NAPTR, NAPTR and SRV queries will be tried before falling to A query. If no port is found through the DNS query, 5060 will be used.

The following details the procedures of DNS query for the IP phone to resolve the domain name (e.g., yealink.pbx.com) of working server into the IP address, port and transport protocol.

NAPTR (Naming Authority Pointer)

First, the IP phone sends NAPTR query to get the NAPTR pointer and transport protocol.

Example of NAPTR records:

	order	pref	flags	service	regexp	replacement
IN NAPTR	90	50	"s"	"SIP+D2T"	""	_sip._tcp.yealink.pbx.com
IN NAPTR	100	50	"s"	"SIP+D2U"	""	_sip._udp.yealink.pbx.com

Parameters are explained in the following table:

Parameter	Description
order	Specify preferential treatment for the specific record. The order is from lowest to highest, lower order is more preferred.
pref	Specify the preference for processing multiple NAPTR records with the same order value. Lower value is more preferred.
Flags	The flag "s" means to perform an SRV lookup.
service	Specify the transport protocols: SIP+D2U: SIP over UDP SIP+D2T: SIP over TCP SIP+D2S: SIP over SCTP SIPS+D2T: SIPS over TCP
regexp	Always empty for SIP services.
replacement	Specify a domain name for the next query.

The IP phone picks the first record, because its order of 90 is lower than 100. The pref parameter is unimportant as there is no other record with order 90. The flag “s” indicates performing the SRV query next. TCP will be used, targeted to a host determined by an SRV query of “_sip._tcp.yealink.pbx.com”. If the flag of the NAPTR record returned is empty, the IP phone will perform NAPTR query again according to the previous NAPTR query result.

SRV (Service Location Record)

The IP phone performs an SRV query on the record returned from the NAPTR for the host name and the port number. Example of SRV records:

	Priority	Weight	Port	Target
IN SRV	0	1	5060	server1.yealink.pbx.com
IN SRV	0	2	5060	server2.yealink.pbx.com

Parameters are explained in the following table:

Parameter	Description
Priority	Specify preferential treatment for the specific host entry. Lower priority is more preferred.
Weight	When priorities are equal, weight is used to differentiate the preference. The preference is from highest to lowest. Keep the same to load balance.
Port	Identify the port number to be used.
Target	Identify the actual host for an A query.

SRV query returns two records. The two SRV records point to different hosts and have the same priority 0. The weight of the second record is higher than the first one, so the second record will be picked first. The two records also contain a port “5060”, the IP phone uses this port. If the Target is not a numeric IP address, the IP phone performs an A query. So in this case, the IP phone uses “server1.yealink.pbx.com” and “server2.yealink.pbx.com” for the A query.

A (Host IP Address)

The IP phone performs an A query for the IP address of each target host name. Example of A records:

```
Server1.yealink.pbx.com IN A    192.168.1.13
Server2.yealink.pbx.com IN A    192.168.1.14
```

The IP phone picks the IP address “192.168.1.14” first.

Outgoing Call When the Working Server Connection Fails

When a user initiates a call, the IP phone will go through the following steps to connect the call:

1. Sends the INVITE request to the primary server.
2. If the primary server does not respond correctly to the INVITE, then tries to make the call using the secondary server.
3. If the secondary server is also unavailable, the IP phone will try the fallback server until it either succeeds in making a call or exhausts all servers at which point the call will fail.

At the start of a call, server availability is determined by SIP signaling failure. SIP signaling failure depends on the SIP protocol being used as described below:

- If TCP is used, then the signaling fails if the connection or the send fails.
- If UDP is used, then the signaling fails if ICMP is detected or if the signal times out. If the signaling has been attempted through all servers in the list and this is the last server, then the signaling fails after the complete UDP timeout defined in [RFC 3261](#). If it is not the last server in the list, the maximum number of retries depends on the configured retry count.

Procedure

SIP Server Domain Name Resolution can be configured using the configuration files or locally.

Configuration File	<MAC>.cfg	Configure the transport type on the IP phone. Parameters: account.X.sip_server.Y.transport_type account.X.naptr_build
Local	Web User Interface	Configure the transport type on the IP phone. Navigate to: http://<phoneIPAddress>/servlet?p=account-register&q=load&acc=0

Details of Configuration Parameters:

Parameters	Permitted Values	Default
account.X.sip_server.Y.transport_type (X ranges from 1 to 16, Y ranges from 1 to 2)	0, 1, 2 or 3	0

Parameters	Permitted Values	Default
<p>Description: Configures the type of transport protocol for account X.</p> <p>0-UDP 1-TCP 2-TLS 3-DNS-NAPTR</p> <p>If the value of the parameter is set to 3 (DNS-NAPTR) and no server port is given, the IP phone performs the DNS NAPTR and SRV queries for the service type and port.</p> <p>X ranges from 1 to 16 (for SIP-T48G/T46G/T29G) X ranges from 1 to 12 (for SIP-T42G) X ranges from 1 to 6 (for SIP-T41P/T27P) X ranges from 1 to 3 (for SIP-T23P/G) X ranges from 1 to 2 (for SIP-T21(P) E2) X is equal to 1 (for SIP-T19(P) E2)</p> <p>Web User Interface: Account->Register->SIP Server Y->Transport</p> <p>Phone User Interface: None</p>		
account.X.naptr_build	0 or 1	0
<p>Description: Configures the way of SRV query for the IP phone to be performed when no result is returned from NAPTR query for account X.</p> <p>0-SRV query using UDP only 1-SRV query using UDP, TCP and TLS</p> <p>X ranges from 1 to 16 (for SIP-T48G/T46G/T29G) X ranges from 1 to 12 (for SIP-T42G) X ranges from 1 to 6 (for SIP-T41P/T27P) X ranges from 1 to 3 (for SIP-T23P/G) X ranges from 1 to 2 (for SIP-T21(P) E2) X is equal to 1 (for SIP-T19(P) E2)</p> <p>Web User Interface: None</p>		

Parameters	Permitted Values	Default
Phone User Interface:		
None		

Static DNS Cache

Failover redundancy can only be utilized when the configured domain name of the server is resolved to multiple IP addresses. If the IP phone is not configured with a DNS server, or the DNS query returns no result from a DNS server, you can configure a set of DNS NAPTR/SRV/A records into the IP phone. The IP phone will attempt to resolve the domain name of the SIP server with static DNS cache.

When the IP phone is configured with a DNS server, the IP phone will behave as follows to resolve domain name of the server:

- The IP phone performs a DNS query to resolve the domain name from the DNS server.
- If the DNS query returns no results for the domain name, or the returned record cannot be contacted, the values in the static DNS cache (if configured) are used when their configured time intervals are not elapsed.
- If the configured time interval is elapsed, the IP phone will attempt to perform a DNS query again.
- If the DNS query returns a result, the IP phone will use the returned record and ignore the statically configured cache values.

When the IP phone is not configured with a DNS server, it will behave as follow:

- The IP phone attempts to resolve the domain name within the static DNS cache.
- The IP phone will always use the results returned from the static DNS cache.

IP phones can be configured to use static DNS cache preferentially. Static DNS cache is configurable on a per-line basis.

Procedure

Static DNS cache can be configured only using the configuration files.

Configuration File	<y0000000000xx>.cfg	<p>Configure NAPTR/SRV/A records.</p> <p>Parameters:</p> <p>dns_cache_naptr.X.name dns_cache_naptr.X.flags dns_cache_naptr.X.order dns_cache_naptr.X.preference dns_cache_naptr.X.replace dns_cache_naptr.X.service dns_cache_naptr.X.ttl dns_cache_srv.X.name dns_cache_srv.X.port dns_cache_srv.X.priority dns_cache_srv.X.target dns_cache_srv.X.weight dns_cache_srv.X.ttl dns_cache_a.X.name dns_cache_a.X.ip dns_cache_a.X.ttl</p>
	<MAC>.cfg	<p>Configure the IP phone whether to cache the additional DNS records.</p> <p>Parameter:</p> <p>account.X.dns_cache_type</p> <p>Configure the IP phone whether to use static DNS cache preferentially.</p> <p>Parameter:</p> <p>account.X.static_cache_pri</p>

Details of Configuration Parameters:

Parameters	Permitted Values	Default
<p>dns_cache_naptr.X.name (X ranges from 1 to 12)</p>	<p>Domain name</p>	<p>Blank</p>
<p>Description:</p>		

Parameters	Permitted Values	Default
<p>Configures the domain name to which NAPTR record X refers.</p> <p>Example: <code>dns_cache_naptr.1.name = yealink.pbx.com</code></p> <p>Web User Interface: None</p> <p>Phone User Interface: None</p>		
<p>dns_cache_naptr.X.flags (X ranges from 1 to 12)</p>	<p>S, A, U or P</p>	<p>Blank</p>
<p>Description: Configures the flag of NAPTR record X. (Always "S" for SIP, which means to do an SRV lookup on whatever is in the replacement field).</p> <p>S-Do an SRV lookup next A-Do an A lookup next U-No need to do a DNS query next P-Service custom by the user</p> <p>Example: <code>dns_cache_naptr.1.flags = S</code></p> <p>Web User Interface: None</p> <p>Phone User Interface: None</p>		
<p>dns_cache_naptr.X.order (X ranges from 1 to 12)</p>	<p>Integer from 0 to 65535</p>	<p>0</p>
<p>Description: Configures the order of NAPTR record X. NAPTR record with lower order is more preferred.</p> <p>Example: <code>dns_cache_naptr.1.order = 90</code></p> <p>Web User Interface: None</p> <p>Phone User Interface: None</p>		

Parameters	Permitted Values	Default
dns_cache_naptr.X.preference (X ranges from 1 to 12)	Integer from 0 to 65535	0
<p>Description: Configures the preference of NAPTR record X. NAPTR record with lower preference is more preferred.</p> <p>Example: dns_cache_naptr.1.preference = 50</p> <p>Web User Interface: None</p> <p>Phone User Interface: None</p>		
dns_cache_naptr.X.replace (X ranges from 1 to 12)	Domain name	Blank
<p>Description: Configures a domain name to be used for the next SRV query in NAPTR record X.</p> <p>Example: dns_cache_naptr.1.replace = _sip_tcp.yealink.pbx.com</p> <p>Web User Interface: None</p> <p>Phone User Interface: None</p>		
dns_cache_naptr.X.service (X ranges from 1 to 12)	String within 32 characters	Blank
<p>Description: Configures the transport protocol available for the server in NAPTR record X.</p> <p>SIP+D2U: SIP over UDP</p> <p>SIP+D2T: SIP over TCP</p> <p>SIP+D2S: SIP over SCTP</p> <p>SIPS+D2T: SIPS over TCP</p> <p>Example: dns_cache_naptr.1.service = SIP+D2T</p> <p>Web User Interface:</p>		

Parameters	Permitted Values	Default
None Phone User Interface: None		
dns_cache_naptr.X.ttl (X ranges from 1 to 12)	Integer from 30 to 2147483647	300
Description: Configures the time interval (in seconds) that NAPTR record X may be cached before the record should be consulted again. Example: dns_cache_naptr.1.ttl = 3600 Web User Interface: None Phone User Interface: None		
dns_cache_srv.X.name (X ranges from 1 to 12)	Domain name	Blank
Description: Configures the domain name in SRV record X. Example: dns_cache_srv.1.name = _sip._tcp.yealink.pbx.com Web User Interface: None Phone User Interface: None		
dns_cache_srv.X.port (X ranges from 1 to 12)	Integer from 0 to 65535	0
Description: Configures the port to be used in SRV record X. Example: dns_cache_srv.1.port = 5060 Web User Interface: None		

Parameters	Permitted Values	Default
Phone User Interface: None		
dns_cache_srv.X.priority (X ranges from 1 to 12)	Integer from 0 to 65535	0
Description: Configures the priority for the target host in SRV record X. Lower priority is more preferred. Web User Interface: None Phone User Interface: None		
dns_cache_srv.X.target (X ranges from 1 to 12)	Domain name	Blank
Description: Configures the domain name of the target host for an A query in SRV record X. Example: dns_cache_srv.1.target = server1.yealink.pbx.com Web User Interface: None Phone User Interface: None		
dns_cache_srv.X.weight (X ranges from 1 to 12)	Integer from 0 to 65535	0
Description: Configures the weight of the target host in SRV record X. When priorities are equal, weight is used to differentiate the preference. Higher weight is more preferred. Example: dns_cache_srv.1.weight = 1 Web User Interface: None Phone User Interface:		

Parameters	Permitted Values	Default
None		
dns_cache_srv.X.ttl (X ranges from 1 to 12)	Integer from 30 to 2147483647	300
<p>Description: Configures the time interval (in seconds) that SRV record X may be cached before the record should be consulted again.</p> <p>Example: dns_cache_srv.1.ttl = 3600</p> <p>Web User Interface: None</p> <p>Phone User Interface: None</p>		
dns_cache_a.X.name (X ranges from 1 to 12)	Domain name	Blank
<p>Description: Configures the domain name in A record X.</p> <p>Example: dns_cache_a.1.name = yealink.pbx.com</p> <p>Web User Interface: None</p> <p>Phone User Interface: None</p>		
dns_cache_a.X.ip (X ranges from 1 to 12)	IP address	Blank
<p>Description: Configures the IP address that the domain name in A record X maps to.</p> <p>Example: dns_cache_a.1.ip = 192.168.1.13</p> <p>Web User Interface: None</p> <p>Phone User Interface: None</p>		

Parameters	Permitted Values	Default
dns_cache_a.X.ttl (X ranges from 1 to 12)	Integer from 30 to 2147483647	300
<p>Description: Configures the time interval (in seconds) that A record X may be cached before the record should be consulted again.</p> <p>Example: dns_cache_a.1.ttl = 3600</p> <p>Web User Interface: None</p> <p>Phone User Interface: None</p>		
account.X.dns_cache_type	0, 1 or 2	1
<p>Description: Configures whether the IP phone uses the DNS cache for domain name resolution of the server and caches the additional DNS records for account X.</p> <p>0-Perform real-time DNS query rather than using DNS cache. 1-Use DNS cache, but do not cache the additional DNS records. 2-Use DNS cache and cache the additional DNS records.</p> <p>X ranges from 1 to 16 (for SIP-T48G/T46G/T29G) X ranges from 1 to 12 (for SIP-T42G) X ranges from 1 to 6 (for SIP-T41P/T27P) X ranges from 1 to 3 (for SIP-T23P/G) X ranges from 1 to 2 (for SIP-T21(P) E2) X is equal to 1 (for SIP-T19(P) E2)</p> <p>Example: account.1.dns_cache_type = 1</p> <p>Web User Interface: None</p> <p>Phone User Interface: None</p>		
account.X.static_cache_pri	0 or 1	0

Parameters	Permitted Values	Default
<p>Description: Configures whether preferentially to use the static DNS cache for domain name resolution of the server for account X.</p> <p>0-Use domain name resolution from the DNS server preferentially 1-Use static DNS cache preferentially</p> <p>X ranges from 1 to 16 (for SIP-T48G/T46G/T29G) X ranges from 1 to 12 (for SIP-T42G) X ranges from 1 to 6 (for SIP-T41P/T27P) X ranges from 1 to 3 (for SIP-T23P/G) X ranges from 1 to 2 (for SIP-T21(P) E2) X is equal to 1 (for SIP-T19(P) E2)</p> <p>Example: account.1.static_cache_pri = 1</p> <p>Web User Interface: None</p> <p>Phone User Interface: None</p>		

VLAN

VLAN (Virtual Local Area Network) is used to logically divide a physical network into several broadcast domains. VLAN membership can be configured through software instead of physically relocating devices or connections. Grouping devices with a common set of requirements regardless of their physical location can greatly simplify network design. VLANs can address issues such as scalability, security and network management.

The purpose of VLAN configurations on the IP phone is to insert tag with VLAN information to the packets generated by the IP phone. When VLAN is properly configured for the ports (Internet port and PC port) on the IP phone, the IP phone will tag all packets from these ports with the VLAN ID. The switch receives and forwards the tagged packets to the corresponding VLAN according to the VLAN ID in the tag as described in IEEE Std 802.3.

VLAN on IP phones allows simultaneous access for a regular PC. This feature allows a PC to be daisy chained to an IP phone and the connection for both PC and IP phone to be trunked through the same physical Ethernet cable.

In addition to manual configuration, the IP phone also supports automatic discovery of VLAN via LLDP, CDP or DHCP. The assignment takes effect in this order: assignment via LLDP/CDP, manual configuration, then assignment via DHCP.

For more information on VLAN, refer to [VLAN Feature on Yealink IP Phones](#).

VLAN assignment method can be configured using the configuration files or locally.

Configuration File	<y0000000000xx>.cfg	Configure the VLAN assignment method. Parameter: network.vlan.vlan_change.enable
---------------------------	---------------------	---

Details of Configuration Parameters:

Parameters	Permitted Values	Default
network.vlan.vlan_change.enable	0 or 1	0
<p>Description: Enables or disables the IP phone to obtain VLAN ID using lower priority of VLAN assignment method or disable VLAN feature when the IP phone cannot obtain VLAN ID using the current VLAN assignment method.</p> <p>0-Disabled 1-Enabled</p> <p>The priority of each method is: LLDP/CDP>Manual>DHCP VLAN.</p> <p>If it is set to 1 (Enabled), the IP phone will attempt to use the lower priority of VLAN assignment method when failing to obtain the VLAN ID using higher priority of VLAN assignment method. If all the methods are attempted, the phone will disable VLAN feature.</p> <p>Note: If you change this parameter, the IP phone will reboot to make the change take effect.</p> <p>Web User Interface: None</p> <p>Phone User Interface: None</p>		

LLDP

LLDP (Linker Layer Discovery Protocol) is a vendor-neutral Link Layer protocol, which allows IP phones to receive and/or transmit device-related information from/to directly

connected devices on the network that are also using the protocol, and store the information about other devices.

When LLDP feature is enabled on IP phones, the IP phones periodically advertise their own information to the directly connected LLDP-enabled switch. The IP phones can also receive LLDP packets from the connected switch. When the application type is "voice", IP phones decide whether to update the VLAN configurations obtained from the LLDP packets. When the VLAN configurations on the IP phones are different from the ones sent by the switch, the IP phones perform an update and reboot. This allows the IP phones to be plugged into any switch, obtain their VLAN IDs, and then start communications with the call control.

Procedure

LLDP can be configured using the configuration files or locally.

Configuration File	<y0000000000xx>.cfg	Configure LLDP. Parameters: network.lldp.enable network.lldp.packet_interval
Local	Web User Interface	Configure LLDP. Navigate to: http://<phoneIPAddress>/servlet?p=network-adv&q=load
	Phone User Interface	Configure LLDP feature.

Details of Configuration Parameters:

Parameters	Permitted Values	Default
network.lldp.enable	0 or 1	1
<p>Description: Enables or disables the LLDP (Linker Layer Discovery Protocol) feature on the IP phone. 0-Disabled 1-Enabled</p> <p>Note: If you change this parameter, the IP phone will reboot to make the change take effect.</p> <p>Web User Interface: Network->Advanced->LLDP->Active</p> <p>Phone User Interface:</p>		

Parameters	Permitted Values	Default
Menu->Settings->Advanced Settings (default password: admin) ->Network->LLDP->LLDP Status		
network.lldp.packet_interval	Integer from 1 to 3600	60
<p>Description: Configures the interval (in seconds) for the IP phone to send the LLDP (Linker Layer Discovery Protocol) request.</p> <p>Note: It works only if the value of the parameter “network.lldp.enable” is set to 1 (Enabled). If you change this parameter, the IP phone will reboot to make the change take effect.</p> <p>Web User Interface: Network->Advanced->LLDP->Packet Interval (1~3600s)</p> <p>Phone User Interface: Menu->Settings->Advanced Settings (default password: admin) ->Network->LLDP->Packet Interval</p>		

To configure LLDP via web user interface:

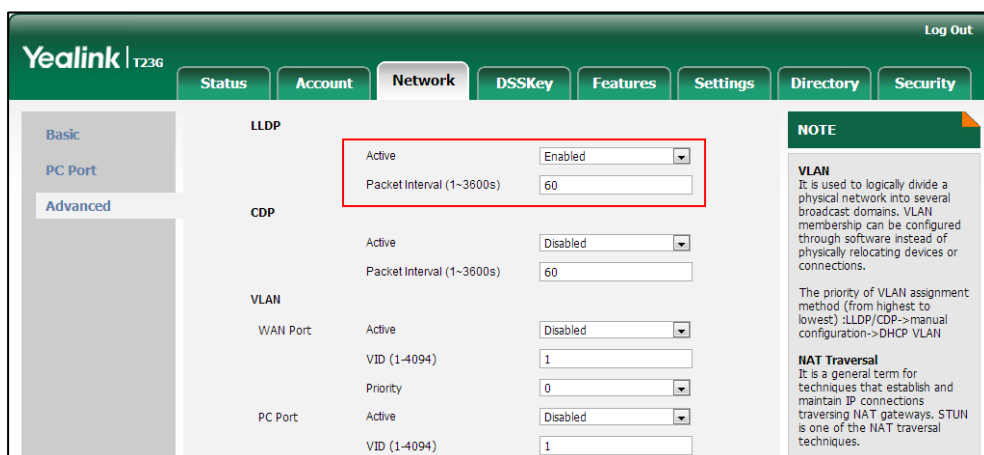

1. Click on **Network->Advanced**.
2. In the **LLDP** block, select the desired value from the pull-down list of **Active**.
3. Enter the desired time interval in the **Packet Interval (1~3600s)** field.



4. Click **Confirm** to accept the change.
A dialog box pops up to prompt that settings will take effect after a reboot.
5. Click **OK** to reboot the phone.

To configure LLDP feature via phone user interface:

1. Press **Menu->Settings->Advanced Settings (default password: admin)**
->**Network->LLDP->LLDP Status**.

2. Press  or , or the **Switch** soft key to select the desired value from the **LLDP Status** field.
3. Enter the priority value (1-3600s) in the **Packet Interval** field.
4. Press the **Save** soft key to accept the change.

The IP phone reboots automatically to make settings effective after a period of time.

CDP

CDP (Cisco Discovery Protocol) allows IP phones to receive and/or transmit device-related information from/to directly connected devices on the network that are also using the protocol, and store the information about other devices.

When CDP feature is enabled on IP phones, the IP phones periodically advertise their own information to the directly connected CDP-enabled switch. The IP phones can also receive CDP packets from the connected switch. When the VLAN configurations on the IP phones are different from the ones sent by the switch, the IP phones perform an update and reboot. This allows the IP phones to be plugged into any switch, obtain their VLAN IDs, and then start communications with the call control.

Procedure

CDP can be configured using the configuration files or locally.

Configuration File	<y0000000000xx>.cfg	Configure CDP. Parameters: network.cdp.enable network.cdp.packet_interval
Local	Web User Interface	Configure CDP. Navigate to: http://<phoneIPAddress>/servlet?<p=network-adv&q=load
	Phone User Interface	Configure CDP feature.

Details of Configuration Parameters:

Parameters	Permitted Values	Default
network.cdp.enable	0 or 1	0
Description: Enables or disables the CDP (Cisco Discovery Protocol) feature on the IP phone. 0-Disabled		

Parameters	Permitted Values	Default
<p>1-Enabled</p> <p>Note: If it is set to 1, the IP phone will attempt to determine its VLAN ID through CDP. If you change this parameter, the IP phone will reboot to make the change take effect.</p> <p>Web User Interface: Network->Advanced->CDP->Active</p> <p>Phone User Interface: Menu->Settings->Advanced Settings (default password: admin) ->Network->CDP->CDP Status</p>		
network.cdp.packet_interval	Integer from 1 to 3600	60
<p>Description: Configures the interval (in seconds) for the IP phone to send the CDP (Cisco Discovery Protocol) request.</p> <p>Note: It works only if the value of the parameter "network.cdp.enable" is set to 1 (Enabled). If you change this parameter, the IP phone will reboot to make the change take effect.</p> <p>Web User Interface: Network->Advanced->CDP->Packet Interval (1~3600s)</p> <p>Phone User Interface: Menu->Settings->Advanced Settings (default password: admin) ->Network->CDP->Packet Interval</p>		

To configure CDP via web user interface:

1. Click on **Network->Advanced**.
2. In the **CDP** block, select the desired value from the pull-down list of **Active**.
3. Enter the desired time interval in the **Packet Interval (1~3600s)** field.

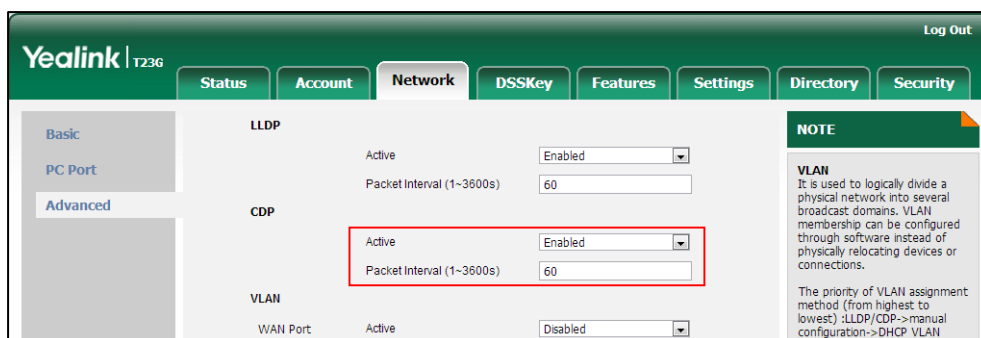



4. Click **Confirm** to accept the change.

A dialog box pops up to prompt that settings will take effect after a reboot.

5. Click **OK** to reboot the phone.

To configure CDP feature via phone user interface:

1. Press **Menu->Settings->Advanced Settings (default password: admin)**
->**Network->CDP->CDP Status**.
2. Press  or , or the **Switch** soft key to select the desired value from the **CDP Status** field.
3. Enter the priority value (1-3600s) in the **Packet Interval** field.
4. Press the **Save** soft key to accept the change.

The IP phone reboots automatically to make settings effective after a period of time.

Manual Configuration for VLAN

VLAN is disabled on IP phones by default. You can configure VLAN for the Internet port and PC port manually. Before configuring VLAN on the IP phone, you need to obtain the VLAN ID from your network administrator.

Procedure

VLAN can be configured using the configuration files or locally.

<p>Configuration File</p>	<p><y0000000000xx>.cfg</p>	<p>Configure VLAN for the Internet port and PC port manually.</p> <p>Parameters:</p> <p>network.vlan.internet_port_enable network.vlan.internet_port_vid network.vlan.internet_port_priority network.vlan.pc_port_enable network.vlan.pc_port_vid network.vlan.pc_port_priority</p>
<p>Local</p>	<p>Web User Interface</p>	<p>Configure VLAN for the Internet port and PC port manually.</p> <p>Navigate to:</p> <p>http://<phoneIPAddress>/servlet?p=network-adv&q=load</p>
	<p>Phone User Interface</p>	<p>Configure VLAN for the Internet port and PC port manually.</p>

Details of Configuration Parameters:

Parameters	Permitted Values	Default
network.vlan.internet_port_enable	0 or 1	0
<p>Description: Enables or disables VLAN for the Internet (WAN) port.</p> <p>0-Disabled 1-Enabled</p> <p>Note: If you change this parameter, the IP phone will reboot to make the change take effect.</p> <p>Web User Interface: Network->Advanced->VLAN->WAN Port->Active</p> <p>Phone User Interface: Menu->Settings->Advanced Settings (default password: admin) ->Network->VLAN->WAN Port->VLAN Status</p>		
network.vlan.internet_port_vid	Integer from 1 to 4094	1
<p>Description: Configures VLAN ID for the Internet (WAN) port.</p> <p>Note: If you change this parameter, the IP phone will reboot to make the change take effect.</p> <p>Web User Interface: Network->Advanced->VLAN->WAN Port->VID (1-4094)</p> <p>Phone User Interface: Menu->Settings->Advanced Settings (default password: admin) ->Network->VLAN->WAN Port->VID</p>		
network.vlan.internet_port_priority	Integer from 0 to 7	0
<p>Description: Configures VLAN priority for the Internet (WAN) port.</p> <p>7 is the highest priority, 0 is the lowest priority.</p> <p>Note: If you change this parameter, the IP phone will reboot to make the change take effect.</p> <p>Web User Interface: Network->Advanced->VLAN->WAN Port->Priority</p>		

Parameters	Permitted Values	Default
Phone User Interface: Menu->Settings->Advanced Settings (default password: admin) ->Network->VLAN->WAN Port->Priority		
network.vlan.pc_port_enable	0 or 1	0
Description: Enables or disables VLAN for the PC (LAN) port. 0-Disabled 1-Enabled Note: If you change this parameter, the IP phone will reboot to make the change take effect. Web User Interface: Network->Advanced->VLAN->PC Port->Active Phone User Interface: Menu->Settings->Advanced Settings (default password: admin) ->Network->VLAN->PC Port->VLAN Status		
network.vlan.pc_port_vid	Integer from 1 to 4094	1
Description: Configures VLAN ID for the PC (LAN) port. Note: If you change this parameter, the IP phone will reboot to make the change take effect. Web User Interface: Network->Advanced->VLAN->PC Port->VID (1-4094) Phone User Interface: Menu->Settings->Advanced Settings (default password: admin) ->Network->VLAN->PC Port->VID		
network.vlan.pc_port_priority	Integer from 0 to 7	0
Description: Configures VLAN priority for the PC (LAN) port. 7 is the highest priority, 0 is the lowest priority. Note: If you change this parameter, the IP phone will reboot to make the change take effect. Web User Interface:		

Parameters	Permitted Values	Default
Network->Advanced->VLAN >PC Port->Priority Phone User Interface: Menu->Settings->Advanced Settings (default password: admin) ->Network->VLAN->PC Port->Priority		

To configure VLAN for Internet port via web user interface:

1. Click on **Network->Advanced**.
2. In the **VLAN** block, select the desired value from the pull-down list of **WAN Port Active**.
3. Enter the VLAN ID in the **VID (1-4094)** field.
4. Select the desired value (0-7) from the pull-down list of **Priority**.

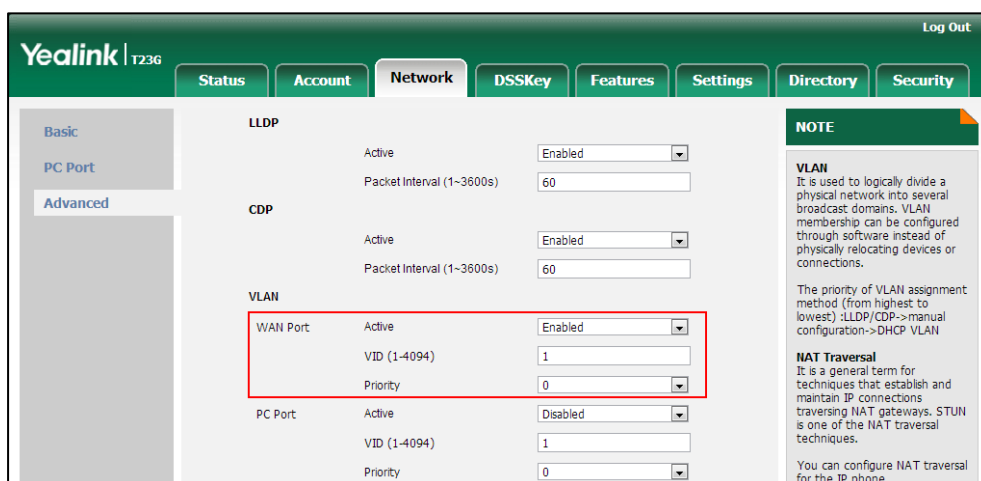

5. Click **Confirm** to accept the change.
 A dialog box pops up to prompt that the settings will take effect after a reboot.
6. Click **OK** to reboot the phone.

To configure VLAN for PC port via web user interface:

1. Click on **Network->Advanced**.
2. In the **VLAN** block, select the desired value from the pull-down list of **PC Port Active**.
3. Enter the VLAN ID in the **VID (1-4094)** field.

- Select the desired value (0-7) from the pull-down list of **Priority**.

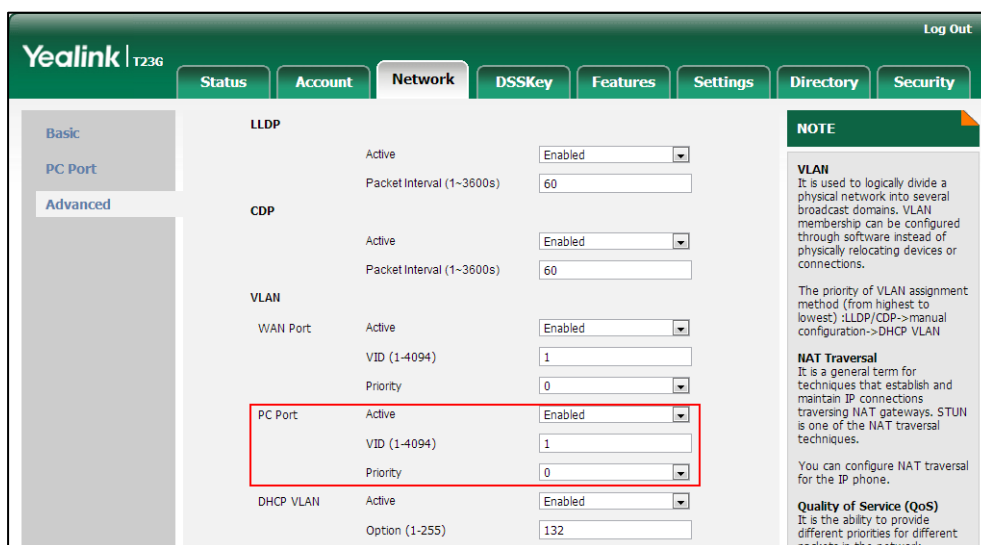

- Click **Confirm** to accept the change.
A dialog box pops up to prompt that the settings will take effect after a reboot.
- Click **OK** to reboot the phone.

To configure VLAN for Internet port (or PC port) via phone user interface:

- Press **Menu->Settings->Advanced Settings** (default password: admin) **->Network->VLAN->WAN Port** (or **PC Port**).
- Press **◀** or **▶** , or the **Switch** soft key to select the desired value from the **VLAN Status** field.
- Enter the VLAN ID (1-4094) in the **VID** field.
- Enter the priority value (0-7) in the **Priority** field.
- Press the **Save** soft key to accept the change.

The IP phone reboots automatically to make settings effective after a period of time.

DHCP VLAN

IP phones support VLAN discovery via DHCP. When the VLAN Discovery method is set to DHCP, the IP phone will examine DHCP option for a valid VLAN ID. The predefined option 132 is used to supply the VLAN ID by default. You can customize the DHCP option used to request the VLAN ID.

Procedure

DHCP VLAN can be configured using the configuration files or locally.

Configuration File	<y0000000000xx>.cfg	Configure DHCP VLAN discovery feature.
---------------------------	---------------------	--

		Parameters: network.vlan.dhcp_enable network.vlan.dhcp_option
Local	Web User Interface	Configure DHCP VLAN discovery feature. Navigate to: http://<phoneIPAddress>/servlet?p=network-adv&q=load
	Phone User Interface	Configure DHCP VLAN discovery feature.

Details of Configuration Parameters:

Parameters	Permitted Values	Default
network.vlan.dhcp_enable	0 or 1	1
Description: Enables or disables DHCP VLAN discovery feature on the IP phone. 0-Disabled 1-Enabled Note: If you change this parameter, the IP phone will reboot to make the change take effect. Web User Interface: Network->Advanced->VLAN->DHCP VLAN->Active Phone User Interface: Menu->Settings->Advanced Settings (default password: admin) ->Network->VLAN->DHCP VLAN->DHCP VLAN		
network.vlan.dhcp_option	Integer from 1 to 255	132
Description: Configures the DHCP option from which the IP phone will obtain the VLAN settings. You can configure at most five DHCP options and separate them by commas. Note: If you change this parameter, the IP phone will reboot to make the change take effect. Web User Interface: Network->Advanced->VLAN->DHCP VLAN->Option (1-255) Phone User Interface: Menu->Settings->Advanced Settings (default password: admin)		

Parameters	Permitted Values	Default
->Network->VLAN->DHCP VLAN->Option		

To configure DHCP VLAN discovery via web user interface:

1. Click on **Network->Advanced**.
2. In the **VLAN** block, select the desired value from the pull-down list of **DHCP VLAN Active**.
3. Enter the desired option in the **Option (1-255)** field.

The default option is 132.

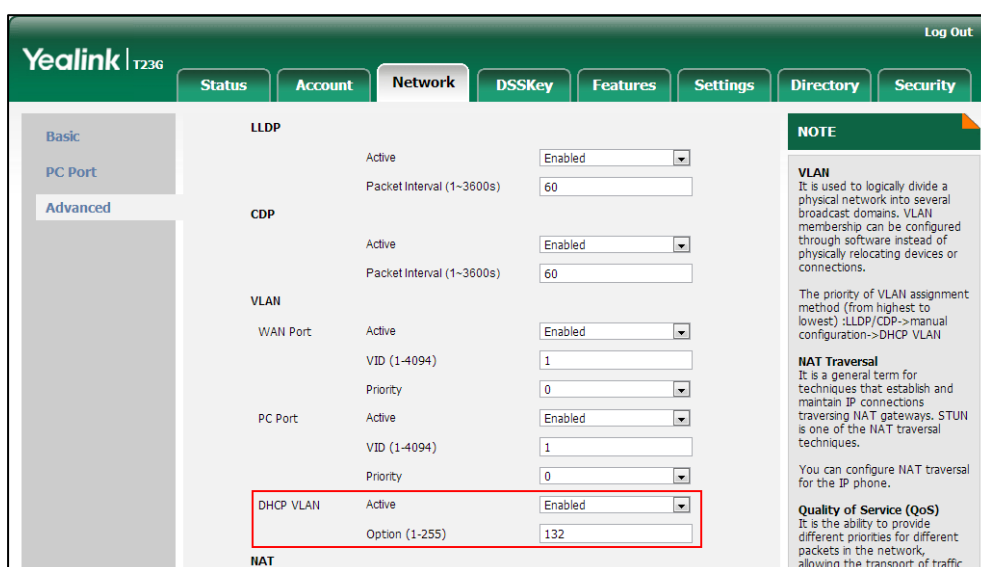

4. Click **Confirm** to accept the change.
A dialog box pops up to prompt that settings will take effect after a reboot.
5. Click **OK** to reboot the phone.

To configure DHCP VLAN discovery via phone user interface:

1. Press **Menu->Settings->Advanced Settings** (default password: admin)
->**Network->VLAN->DHCP VLAN**.
2. Press **◀** or **▶**, or the **Switch** soft key to select the desired value from the **DHCP VLAN** field.
3. Enter the desired option in the **Option** field.
4. Press the **Save** soft key to accept the change.

The IP phone reboots automatically to make settings effective after a period of time.

VPN

VPN (Virtual Private Network) is a secured private network connection built on top of public telecommunication infrastructure, such as the Internet. It has become more prevalent due to benefits of scalability, reliability, convenience and security. VPN provides remote offices or individual users with secure access to their organization's network. There are two types of VPN access: remote-access VPN (connecting an individual device to a network) and site-to-site VPN (connecting two networks together). Remote-access VPN allows employees to access their company's intranet from home or outside the office, and site-to-site VPN allows employees in geographically separated offices to share one cohesive virtual network. VPN can be also classified by the protocols used to tunnel the traffic. It provides security through tunneling protocols: IPSec, SSL, L2TP and PPTP.

IP phones support SSL VPN, which provides remote-access VPN capabilities through SSL. OpenVPN is a full featured SSL VPN software solution that creates secure connections in remote access facilities, designed to work with the TUN/TAP virtual network interface. TUN and TAP are virtual network kernel devices. TAP simulates a link layer device and provides a virtual point-to-point connection, while TUN simulates a network layer device and provides a virtual network segment. IP phones use OpenVPN to achieve VPN feature. To prevent disclosure of private information, tunnel endpoints must authenticate each other before secure VPN tunnel is established. After VPN feature is configured properly on the IP phone, the IP phone acts as a VPN client and uses the certificates to authenticate the VPN server.

To use VPN, the compressed package of VPN-related files should be uploaded to the IP phone in advance. The file format of the compressed package must be *.tar. The related VPN files are: certificates (ca.crt and client.crt), key (client.key) and the configuration file (vpn.cnf) of the VPN client.

The following table lists the unified directories of the OpenVPN certificates and key in the configuration file (vpn.cnf) for Yealink IP phones:

VPN files	Description	Unified Directories
ca.crt	CA certificate	/config/openvpn/keys/ca.crt
client.crt	Server certificate	/config/openvpn/keys/client.crt
client.key	Private key of the client	/config/openvpn/keys/client.key

For more information, refer to [OpenVPN Feature on Yealink IP Phones](#).

Note

VPN is not applicable to SIP-T19(P) E2 IP phones.

Procedure

VPN can be configured using the configuration files or locally.

Configuration File	<y0000000000xx>.cfg	Configure VPN feature and upload a TAR file to the IP phone. Parameters: network.vpn_enable openvpn.url
Local	Web User Interface	Configure VPN feature and upload a TAR package to the IP phone. Navigate to: http://<phoneIPAddress>/servlet?parameter=network-adv&q=load
	Phone User Interface	Configure VPN feature.

Details of Configuration Parameters:

Parameters	Permitted Values	Default
network.vpn_enable	0 or 1	0
<p>Description: Enables or disables OpenVPN feature on the IP phone.</p> <p>0-Disabled 1-Enabled</p> <p>Note: If you change this parameter, the IP phone will reboot to make the change take effect. It is not applicable to SIP-T19(P) E2 IP phones.</p> <p>Web User Interface: Network->Advanced->VPN->Active</p> <p>Phone User Interface: Menu->Settings->Advanced Settings (default: admin) ->Network->VPN->VPN Active</p>		
openvpn.url	URL within 511 characters	Blank
<p>Description: Configures the access URL of the *.tar file for OpenVPN.</p> <p>Example:</p>		

Parameters	Permitted Values	Default
openvpn.url = http://192.168.10.25/OpenVPN.tar Note: It is not applicable to SIP-T19(P) E2 IP phones. Web User Interface: Network->Advanced->VPN->Upload VPN Config Phone User Interface: None		

To upload a TAR file and configure VPN via web user interface:

1. Click on **Network->Advanced**.
2. Click **Browser** to locate the TAR file from the local system.
3. Click **Upload** to upload the TAR file.

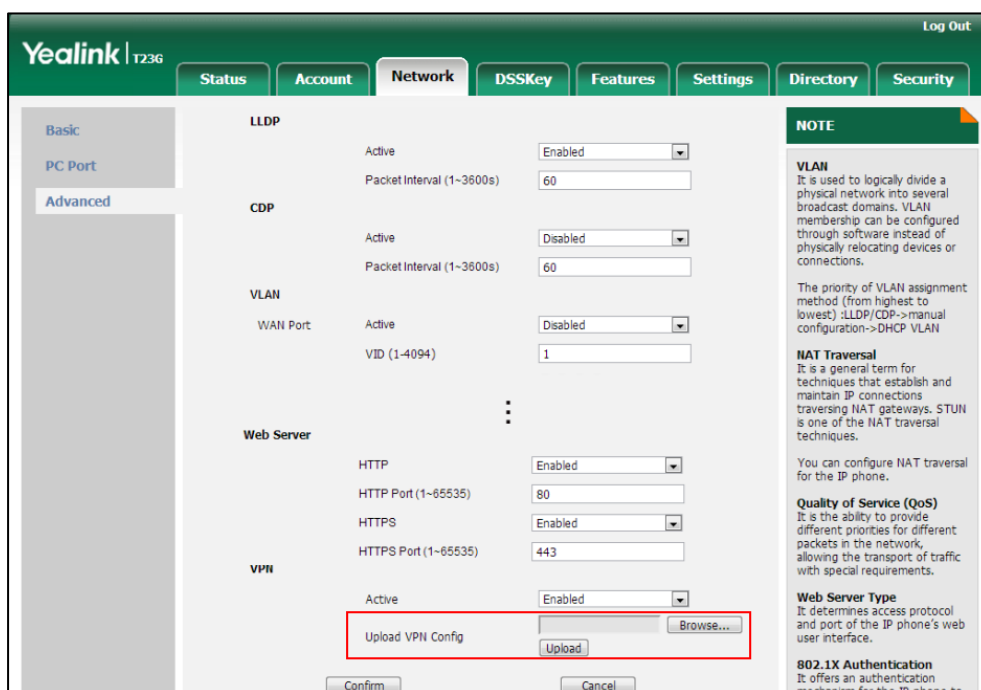

The web user interface prompts the message “Import config...”.

4. In the **VPN** block, select the desired value from the pull-down list of **Active**.
5. Click **Confirm** to accept the change.

A dialog box pops up to prompt that settings will take effect after a reboot.

6. Click **OK** to reboot the phone.

To configure VPN via phone user interface after uploading a TAR file:

1. Press **Menu->Settings->Advanced Settings** (default password: admin) **->Network->VPN**.
2. Press **◀** or **▶**, or the **Switch** soft key to select the desired value from the **VPN**

Active field.

You must upload the OpenVPN TAR file using configuration files or via web user interface in advance.

3. Press the **Save** soft key to accept the change.

The IP phone reboots automatically to make settings effective after a period of time.

Voice Quality Monitoring

Voice quality monitoring feature allows the IP phones to generate various quality metrics for listening quality and conversational quality. These metrics can be sent between the phones in RTCP-XR packets. These metrics can also be sent in SIP PUBLISH messages to a central voice quality report collector. Two mechanisms for voice quality monitoring are supported by Yealink IP phones:

- RTCP-XR
- VQ-RTCPXR

RTCP-XR

The RTCP-XR mechanism, compliant with [RFC 3611-RTP Control Extended Reports \(RTCP-XR\)](#), provides the metrics contained in RTCP-XR packets for monitoring the quality of calls. These metrics include network packet loss, delay metrics, analog metrics and voice quality metrics.

Procedure

RTCP-XR can be configured using the configuration files.

Configuration File	<y0000000000xx>.cfg	Configure RTCP-XR. Parameter: voice.rtcp_xr.enable phone_setting.rtcp_xr_report.enable
---------------------------	---------------------	--

Details of Configuration Parameters:

Parameters	Permitted Values	Default
voice.rtcp_xr.enable	0 or 1	0
Description: Enables or disables the IP phone to send RTCP-XR packets. 0-Disabled		

Parameters	Permitted Values	Default
1-Enabled Note: If you change this parameter, the IP phone will reboot to make the change take effect. Web User Interface: None Phone User Interface: None		
<code>phone_setting.rtcp_xr_report.enable</code>	0 or 1	0
Description: Enables or disables the IP phone to periodically (every 5 seconds) send RTCP-XR packets to another participating phone during a call for call quality monitoring and diagnosing. 0-Disabled 1-Enabled Note: It works only if the value of the parameter “voice.rtcp_xr.enable” is set to 1 (Enabled). If you change this parameter, the IP phone will reboot to make the change take effect. Web User Interface: None Phone User Interface: None		

VQ-RTCPXR

The VQ-RTCPXR mechanism, compliant with [RFC 6035](#), sends the service quality metric reports contained in SIP PUBLISH messages to the central report collector. Three types of quality reports can be enabled:

- **Session:** Generated at the end of a call.
- **Interval:** Generated during a call at a configurable period.
- **Alert:** Generated when the call quality degrades below a configurable threshold.

A wide range of performance metrics are generated in the following two ways:

- Based on current values, such as jitter, jitter buffer max and round trip delay.
- Computed using other metrics as input, such as listening Mean Opinion Score (MOS-LQ) and conversational Mean Opinion Score (MOS-CQ).

To operate with central report collector, IP phones must be configured to forward their voice quality reports to the specified report collector. You can specify the report collector on a per-line basis.

Users can check the voice quality data of the last call via web user interface or phone user interface. Users can also specify the options of the RTP status to be displayed on the phone user interface. Options of the RTP status to be displayed on the web user interface cannot be specified.

Procedure

VQ-RTCPXR can be configured using the configuration files or locally.

<p>Configuration File</p>	<p><y0000000000xx>.cfg</p>	<p>Configure the generation of session packets.</p> <p>Parameter:</p> <p>phone_setting.vq_rtcpxr.session_report.enable</p> <p>Configure the generation of interval packets.</p> <p>Parameters:</p> <p>phone_setting.vq_rtcpxr.interval_report.enable</p> <p>phone_setting.vq_rtcpxr_interval_period</p> <p>Configure the generation of alert packets.</p> <p>Parameters:</p> <p>phone_setting.vq_rtcpxr_moslq_threshold_warning</p> <p>phone_setting.vq_rtcpxr_moslq_threshold_critical</p> <p>phone_setting.vq_rtcpxr_delay_threshold_warning</p> <p>phone_setting.vq_rtcpxr_delay_threshold_critical</p> <p>Configure the phone to display RTP status showing the voice quality report of the last call on the web user interface.</p> <p>Parameter:</p> <p>phone_setting.vq_rtcpxr.states_show_on_web.enable</p> <p>Configure the phone to display RTP status showing the voice quality report of the last call or the current call on the phone</p>
----------------------------------	----------------------------------	---

		<p>user interface.</p> <p>Parameter:</p> <p>phone_setting.vq_rtcpxr.states_show_on_gui.enable</p> <p>Configure the options of the RTP status displayed on the phone user interface.</p> <p>Parameters:</p> <p>phone_setting.vq_rtcpxr_display_start_time.enable</p> <p>phone_setting.vq_rtcpxr_display_stop_time.enable</p> <p>phone_setting.vq_rtcpxr_display_local_call_id.enable</p> <p>phone_setting.vq_rtcpxr_display_remote_call_id.enable</p> <p>phone_setting.vq_rtcpxr_display_local_codec.enable</p> <p>phone_setting.vq_rtcpxr_display_remote_codec.enable</p> <p>phone_setting.vq_rtcpxr_display_jitter.enable</p> <p>phone_setting.vq_rtcpxr_display_jitter_buffer_max.enable</p> <p>phone_setting.vq_rtcpxr_display_packets_lost.enable</p> <p>phone_setting.vq_rtcpxr_display_symm_oneway_delay.enable</p> <p>phone_setting.vq_rtcpxr_display_round_trip_delay.enable</p> <p>phone_setting.vq_rtcpxr_display_moslq.enable</p> <p>phone_setting.vq_rtcpxr_display_mosqc.enable</p>
	<p><MAC>.cfg</p>	<p>Configure the central report collector.</p> <p>Parameters:</p> <p>account.X.vq_rtcpxr.collector_name</p> <p>account.X.vq_rtcpxr.collector_server_host</p> <p>account.X.vq_rtcpxr.collector_server_port</p>
<p>Local</p>	<p>Web User Interface</p>	<p>Configure VQ-RTCPXR.</p>

		<p>Configure the phone to display RTP status showing the voice quality report of the last call on the web user interface.</p> <p>Configure the phone to display RTP status showing the voice quality report of the last call or the current call on the phone user interface.</p> <p>Configure the options of the RTP status displayed on the phone user interface.</p> <p>Navigate to: <a href="http://<phoneIPAddress>/servlet?p=settings-voicemonitoring&q=load">http://<phoneIPAddress>/servlet?p=settings-voicemonitoring&q=load</p> <p>Configure the central report collector.</p> <p>Navigate to: <a href="http://<phoneIPAddress>/servlet?p=account-adv&q=load&acc=0">http://<phoneIPAddress>/servlet?p=account-adv&q=load&acc=0</p>
--	--	--

Details of Configuration Parameters:

Parameters	Permitted Values	Default
phone_setting.vq_rtcp.r.session_report.enable	0 or 1	0
<p>Description: Enables or disables the IP phone to send a session quality report to the central report collector at the end of each call.</p> <p>0-Disabled 1-Enabled</p> <p>Web User Interface: Settings->Voice Monitoring->VQ RTCP-XR Session Report</p> <p>Phone User Interface: None</p>		
phone_setting.vq_rtcp.r.interval_report.enable	0 or 1	0

Parameters	Permitted Values	Default
<p>Description: Enables or disables the IP phone to send an interval quality report to the central report collector periodically throughout a call.</p> <p>0-Disabled 1-Enabled</p> <p>Web User Interface: Settings->Voice Monitoring->VQ RTCP-XR Interval Report</p> <p>Phone User Interface: None</p>		
phone_setting.vq_rtcpxr_interval_period	Integer from 5 to 20	20
<p>Description: Configures the interval (in seconds) for the IP phone to send an interval quality report to the central report collector periodically throughout a call.</p> <p>Note: It works only if the value of the parameter “phone_setting.vq_rtcpxr.interval_report.enable” is set to 1 (Enabled).</p> <p>Web User Interface: Settings->Voice Monitoring->Period for Interval Report</p> <p>Phone User Interface: None</p>		
phone_setting.vq_rtcpxr_moslq_threshold_warning	15 to 40	Blank
<p>Description: Configures the threshold value of listening MOS score (MOS-LQ) multiplied by 10. The threshold value of MOS-LQ causes the phone to send a warning alert quality report to the central report collector.</p> <p>For example, a configured value of 35 corresponds to the MOS score 3.5. When the MOS-LQ value computed by the phone is less than or equal to 3.5, the phone will send a warning alert quality report to the central report collector. When the MOS-LQ value computed by the phone is greater than 3.5, the phone will not send a warning alert quality report to the central report collector.</p> <p>If it is set to blank, warning alerts are not generated due to MOS-LQ.</p> <p>Web User Interface: Settings->Voice Monitoring->Warning threshold for Moslq</p>		

Parameters	Permitted Values	Default
Phone User Interface: None		
phone_setting.vq_rtcpxr_moslq_threshold_critical	15 to 40	Blank
<p>Description: Configures the desired threshold value of listening MOS score (MOS-LQ) multiplied by 10. The threshold value of MOS-LQ causes the phone to send a critical alert quality report to the central report collector.</p> <p>For example, a configured value of 28 corresponds to the MOS score 2.8. When the MOS-LQ value computed by the phone is less than or equal to 2.8, the phone will send a critical alert quality report to the central report collector. When the MOS-LQ value computed by the phone is greater than 2.8, the phone will not send a critical alert quality report to the central report collector.</p> <p>If it is set to blank, critical alerts are not generated due to MOS-LQ.</p> <p>Web User Interface: Settings->Voice Monitoring->Critical threshold for Moslq</p> <p>Phone User Interface: None</p>		
phone_setting.vq_rtcpxr_delay_threshold_warning	10 to 2000	Blank
<p>Description: Configures the threshold value of one way delay (in milliseconds) that causes the phone to send a warning alert quality report to the central report collector.</p> <p>For example, If it is set to 500, when the value of one way delay computed by the phone is less than or equal to 500, the phone will send a warning alert quality report to the central report collector; when the value of one way delay computed by the phone is greater than 500, the phone will not send a warning alert quality report to the central report collector.</p> <p>If it is set to blank, warning alerts are not generated due to one way delay. One-way delay includes both network delay and end system delay.</p> <p>Web User Interface: Settings->Voice Monitoring->Warning threshold for Delay</p> <p>Phone User Interface: None</p>		
phone_setting.vq_rtcpxr_delay_threshold_critical	10 to 2000	Blank

Parameters	Permitted Values	Default
<p>Description: Configures the threshold value of one way delay (in milliseconds) that causes phone to send a critical alert quality report to the central report collector. For example, If it is set to 500, when the value of one way delay computed by the phone is less than or equal to 500, the phone will send a critical alert quality report to the central report collector; when the value of one way delay computed by the phone is greater than 500, the phone will not send a critical alert quality report to the central report collector. If it is set to blank, critical alerts are not generated due to one way delay. One-way delay includes both network delay and end system delay.</p> <p>Web User Interface: Settings->Voice Monitoring->Critical threshold for Delay</p> <p>Phone User Interface: None</p>		
phone_setting.vq_rtcp.rstates_show_on_web.enable	0 or 1	0
<p>Description: Enables or disables the voice quality data of the last call to be displayed on web interface at path Status->RTP Status. 0-Disabled 1-Enabled</p> <p>Web User Interface: Settings->Voice Monitoring->Display Report options on Web</p> <p>Phone User Interface: None</p>		
phone_setting.vq_rtcp.rstates_show_on_gui.enable	0 or 1	0
<p>Description: Enables or disables the voice quality data of the last call or current call to be displayed on the LCD screen. You can view the voice quality data of the last call on the phone at the path Menu->Status->More->RTP (RTP Status). You can view the voice quality data of the current call by pressing RTP/RTP Status soft key during a call. 0-Disabled 1-Enabled</p> <p>Web User Interface: Settings->Voice Monitoring->Display Report options on phone</p>		

Parameters	Permitted Values	Default
Phone User Interface: None		
phone_setting.vq_rtcpxr_display_start_time.enable	0 or 1	1
Description: Enables or disables the phone to display Start Time on the LCD screen. 0-Disabled 1-Enabled Note: It works only if the value of the parameter "phone_setting.vq_rtcpxr.states_show_on_gui.enable" is set to 1 (Enabled). Web User Interface: Settings->Voice Monitoring->Report options on phone->Start Time Phone User Interface: None		
phone_setting.vq_rtcpxr_display_stop_time.enable	0 or 1	1
Description: Enables or disables the phone to display Current Time or Stop Time on the LCD screen. 0-Disabled 1-Enabled Note: It works only if the value of the parameter "phone_setting.vq_rtcpxr.states_show_on_gui.enable" is set to 1 (Enabled). Web User Interface: Settings->Voice Monitoring->Report options on phone->Current Time Phone User Interface: None		
phone_setting.vq_rtcpxr_display_local_call_id.enable	0 or 1	1
Description: Enables or disables the phone to display Local User on the LCD screen. 0-Disabled 1-Enabled Note: It works only if the value of the parameter "phone_setting.vq_rtcpxr.states_show_on_gui.enable" is set to 1 (Enabled).		

Parameters	Permitted Values	Default
<p>Web User Interface: Settings->Voice Monitoring->Report options on phone->Local User</p> <p>Phone User Interface: None</p>		
phone_setting.vq_rtcp_xr_display_remote_call_id.enable	0 or 1	1
<p>Description: Enables or disables the phone to display Remote User on the LCD screen. 0-Disabled 1-Enabled</p> <p>Note: It works only if the value of the parameter "phone_setting.vq_rtcp_xr_states_show_on_gui.enable" is set to 1 (Enabled).</p> <p>Web User Interface: Settings->Voice Monitoring->Report options on phone->Remote User</p> <p>Phone User Interface: None</p>		
phone_setting.vq_rtcp_xr_display_local_codec.enable	0 or 1	1
<p>Description: Enables or disables the phone to display Local Codec on the LCD screen. 0-Disabled 1-Enabled</p> <p>Note: It works only if the value of the parameter "phone_setting.vq_rtcp_xr_states_show_on_gui.enable" is set to 1 (Enabled).</p> <p>Web User Interface: Settings->Voice Monitoring->Report options on phone->Local Codec</p> <p>Phone User Interface: None</p>		
phone_setting.vq_rtcp_xr_display_remote_codec.enable	0 or 1	1
<p>Description: Enables or disables the phone to display Remote Codec on the LCD screen. 0-Disabled 1-Enabled</p>		

Parameters	Permitted Values	Default
<p>Note: It works only if the value of the parameter "phone_setting.vq_rtcpxr.states_show_on_gui.enable" is set to 1 (Enabled).</p> <p>Web User Interface: Settings->Voice Monitoring->Report options on phone->Remote Codec</p> <p>Phone User Interface: None</p>		
phone_setting.vq_rtcpxr_display_jitter.enable	0 or 1	1
<p>Description: Enables or disables the phone to display Jitter on the LCD screen.</p> <p>0-Disabled 1-Enabled</p> <p>Note: It works only if the value of the parameter "phone_setting.vq_rtcpxr.states_show_on_gui.enable" is set to 1 (Enabled).</p> <p>Web User Interface: Settings->Voice Monitoring->Report options on phone->Jitter</p> <p>Phone User Interface: None</p>		
phone_setting.vq_rtcpxr_display_jitter_buffer_max.enable	0 or 1	1
<p>Description: Enables or disables the phone to display JitteBufferMax on the LCD screen.</p> <p>0-Disabled 1-Enabled</p> <p>Note: It works only if the value of the parameter "phone_setting.vq_rtcpxr.states_show_on_gui.enable" is set to 1 (Enabled).</p> <p>Web User Interface: Settings->Voice Monitoring->Report options on phone->JitteBufferMax</p> <p>Phone User Interface: None</p>		
phone_setting.vq_rtcpxr_display_packets_lost.enable	0 or 1	1

Parameters	Permitted Values	Default
<p>Description: Enables or disables the phone to display Packets Lost on the LCD screen. 0-Disabled 1-Enabled Note: It works only if the value of the parameter "phone_setting.vq_rtcpxr.states_show_on_gui.enable" is set to 1 (Enabled). Web User Interface: Settings->Voice Monitoring->Report options on phone->Packets Lost Phone User Interface: None</p>		
phone_setting.vq_rtcpxr_display_symm_oneway_delay.enable	0 or 1	0
<p>Description: Enables or disables the phone to display SymmOneWayDelay on the LCD screen. 0-Disabled 1-Enabled Note: It works only if the value of the parameter "phone_setting.vq_rtcpxr.states_show_on_gui.enable" is set to 1 (Enabled). Web User Interface: Settings->Voice Monitoring->Report options on phone->SymmOneWayDelay Phone User Interface: None</p>		
phone_setting.vq_rtcpxr_display_round_trip_delay.enable	0 or 1	0
<p>Description: Enables or disables the phone to display RoundTripDelay on the LCD screen. 0-Disabled 1-Enabled Note: It works only if the value of the parameter "phone_setting.vq_rtcpxr.states_show_on_gui.enable" is set to 1 (Enabled). Web User Interface: Settings->Voice Monitoring->Report options on phone->RoundTripDelay Phone User Interface: None</p>		

Parameters	Permitted Values	Default
phone_setting.vq_rtcp_xr_display_moslq.enable	0 or 1	1
<p>Description: Enables or disables the phone to display MOS-LQ on the LCD screen. 0-Disabled 1-Enabled Note: It works only if the value of the parameter "phone_setting.vq_rtcp_xr.states_show_on_gui.enable" is set to 1 (Enabled). Web User Interface: Settings->Voice Monitoring->Report options on phone->MOS-LQ Phone User Interface: None</p>		
phone_setting.vq_rtcp_xr_display_mos_cq.enable	0 or 1	1
<p>Description: Enables or disables the phone to display MOS-CQ on the LCD screen. 0-Disabled 1-Enabled Note: It works only if the value of the parameter "phone_setting.vq_rtcp_xr.states_show_on_gui.enable" is set to 1 (Enabled). Web User Interface: Settings->Voice Monitoring->Report options on phone->MOS-CQ Phone User Interface: None</p>		
account.X.vq_rtcp_xr.collector_name	String within 32 characters	Blank

Parameters	Permitted Values	Default
<p>Description: Configures the host name of the central report collector that accepts voice quality reports contained in SIP PUBLISH messages for account X. X ranges from 1 to 16 (for SIP-T48G/T46G/T29G) X ranges from 1 to 12 (for SIP-T42G) X ranges from 1 to 6 (for SIP-T41P/T27P) X ranges from 1 to 3 (for SIP-T23P/G) X ranges from 1 to 2 (for SIP-T21(P) E2) X is equal to 1 (for SIP-T19(P) E2)</p> <p>Web User Interface: Account->Advanced->VQ RTCP-XR Collector name</p> <p>Phone User Interface: None</p>		
account.X.vq_rtcp_xr.collector_server_host	IPv4 Address	Blank
<p>Description: Configures the IP address of the central report collector that accepts voice quality reports contained in SIP PUBLISH messages for account X. X ranges from 1 to 16 (for SIP-T48G/T46G/T29G) X ranges from 1 to 12 (for SIP-T42G) X ranges from 1 to 6 (for SIP-T41P/T27P) X ranges from 1 to 3 (for SIP-T23P/G) X ranges from 1 to 2 (for SIP-T21(P) E2) X is equal to 1 (for SIP-T19(P) E2)</p> <p>Web User Interface: Account->Advanced->VQ RTCP-XR Collector address</p> <p>Phone User Interface: None</p>		
account.X.vq_rtcp_xr.collector_server_port	Integer from 1 to 65535	5060
<p>Description: Configures the port of the central report collector that accepts voice quality reports contained in SIP PUBLISH messages for account X.</p>		

Parameters	Permitted Values	Default
X ranges from 1 to 16 (for SIP-T48G/T46G/T29G)		
X ranges from 1 to 12 (for SIP-T42G)		
X ranges from 1 to 6 (for SIP-T41P/T27P)		
X ranges from 1 to 3 (for SIP-T23P/G)		
X ranges from 1 to 2 (for SIP-T21(P) E2)		
X is equal to 1 (for SIP-T19(P) E2)		
Web User Interface:		
Account->Advanced->VQ RTCP-XR Collector port		
Phone User Interface:		
None		

To configure session report for VQ-RTCPXR via web user interface:

1. Click on **Settings->Voice Monitoring**.
2. Select the desired value from the pull-down list of **VQ RTCP-XR Session Report**.

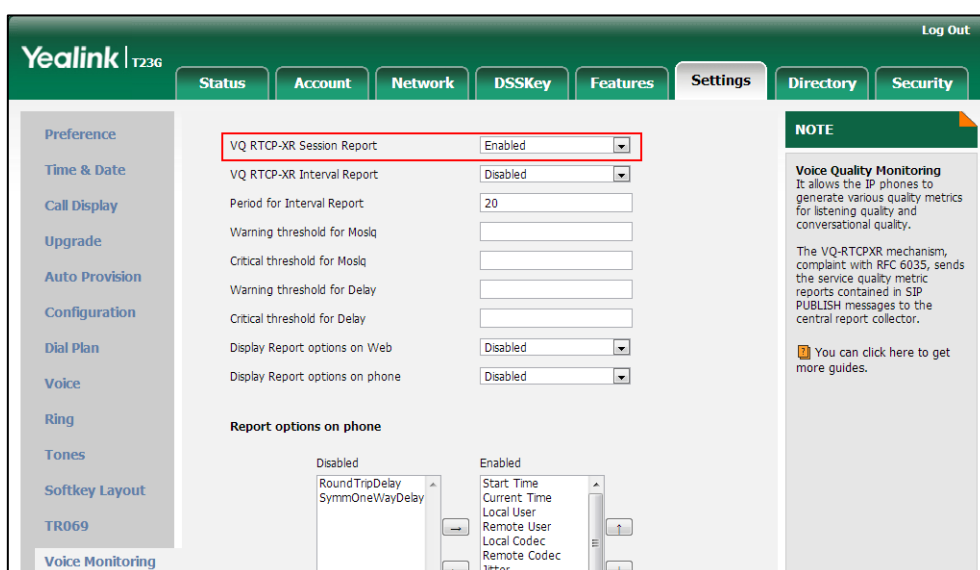

3. Click **Confirm** to accept the change.

To configure interval report for VQ-RTCPXR via web user interface:

1. Click on **Settings->Voice Monitoring**.
2. Select the desired value from the pull-down list of **VQ RTCP-XR Interval Report**.

3. Enter the desired value in the **Period for Interval Report** field.

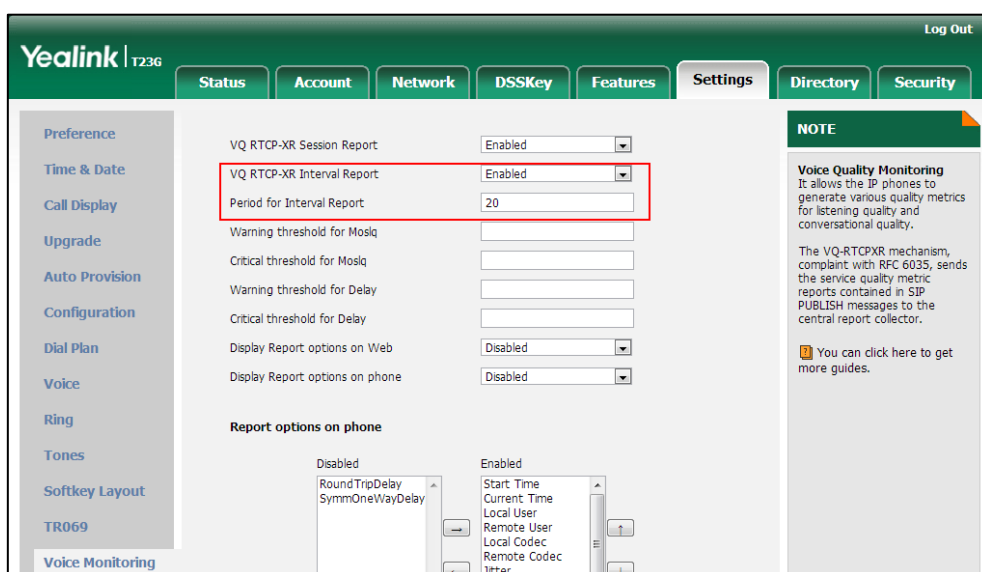

4. Click **Confirm** to accept the change.

To configure alert report for VQ-RTCPXR via web user interface:

1. Click on **Settings->Voice Monitoring**.
2. Enter the desired value in the **Warning threshold for Moslq** field.
3. Enter the desired value in the **Critical threshold for Moslq** field.
4. Enter the desired value in the **Warning threshold for Delay** field.
5. Enter the desired value in the **Critical threshold for Delay** field.

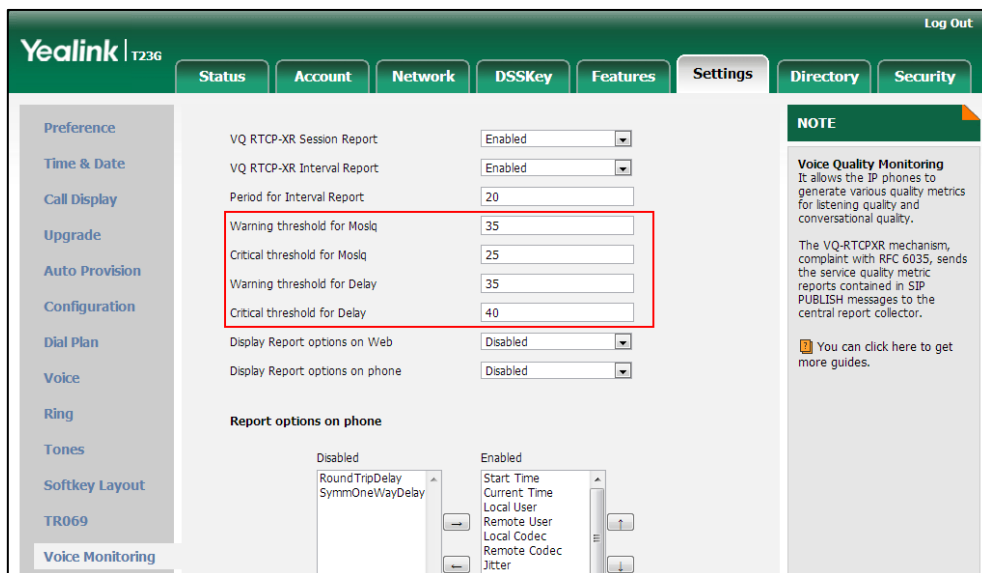

6. Click **Confirm** to accept the change.

To configure RTP status displayed on the web page via web user interface:

1. Click on **Settings->Voice Monitoring**.

2. Select the desired value from the pull-down list of **Display Report options on Web**.

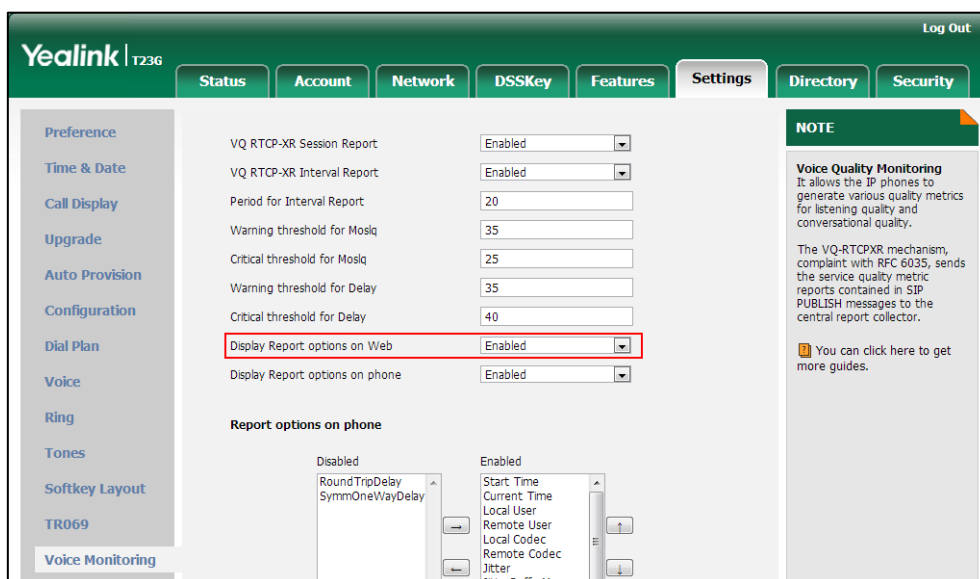

3. Click **Confirm** to accept the change.

The RTP status will appear on the web user interface at the path: **Status->RTP Status**.

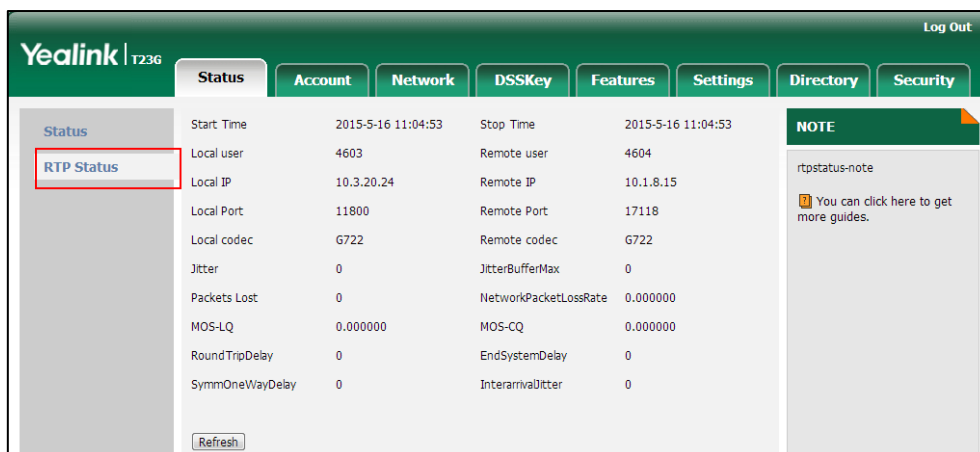

To configure RTP status displayed on the LCD screen via web user interface:

1. Click on **Settings->Voice Monitoring**.

2. Select the desired value from the pull-down list of **Display Report options on phone**.

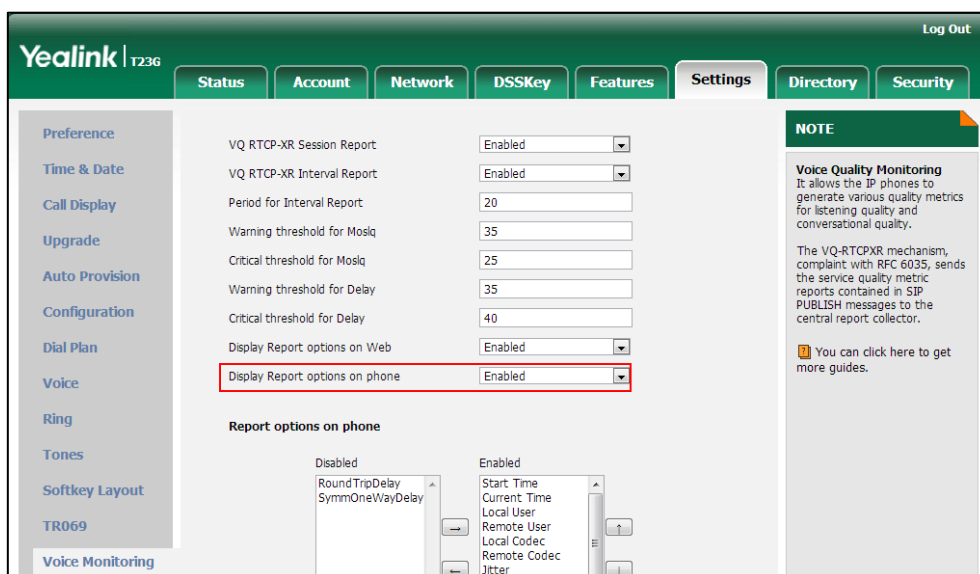

3. Click **Confirm** to accept the change.

The RTP status will appear on the phone user interface at the path:



Menu->Status->More....

To configure the options of the RTP status displayed on the LCD screen via web user interface:

1. Click on **Settings->Voice Monitoring**.
2. In the **Report options on phone** block, select the desired list from the **Disabled** column and then click .

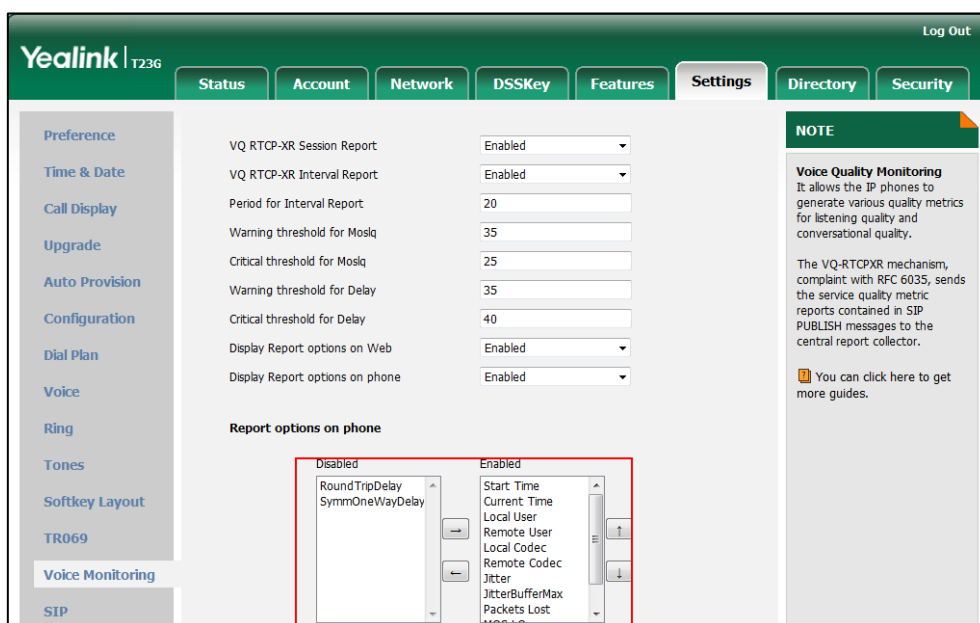
The selected list appears in the **Enabled** column.



3. Repeat step 2 to add more items to the **Enabled** column.
4. To remove an item from the **Enabled** column, select the desired item and then click .
5. To adjust the display order of enabled items, select the desired item and then click  or .

The LCD screen will display the item(s) in the adjusted order.

6. Click **Confirm** to accept the change.

To configure the central report collector via web user interface:

1. Click on **Account->Advanced**.
2. Enter the host name of the central report collector in the **VQ RTCP-XR Collector name** field.
3. Enter the IP address of the central report collector in the **VQ RTCP-XR Collector address** field.

- Enter the port of the central report collector in the **VQ RTPC-XR Collector port** field.

The screenshot shows the Yealink T236 web interface with the 'Account' tab selected. The 'Account 1' configuration page is displayed. The 'VQ RTPC-XR Collector port' field is highlighted with a red box. The configuration includes various fields for account settings, such as 'Keep Alive Type', 'Keep Alive Interval(Seconds)', 'RPort', 'Subscribe Period(Seconds)', 'Shared Line', 'Dialog Info Call Pickup', 'BLA Number', 'BLA Subscription Period', 'SIP Send MAC', 'BLF List Retrieve Call Parked Code', 'Shared Line', 'Call Pull Feature Access Code', 'Dialog Info Call Pickup', 'VQ RTPC-XR Collector name', 'VQ RTPC-XR Collector address', and 'VQ RTPC-XR Collector port'. The 'VQ RTPC-XR Collector port' field is set to 5060. A 'NOTE' section on the right provides information about DTMF, Session Timer, Busy Lamp Field/BLF List, Shared Call Appearance (SCA)/ Bridge Line Appearance (BLA), and Network Conference.

- Click **Confirm** to accept the change.

Quality of Service

Quality of Service (QoS) is the ability to provide different priorities for different packets in the network, allowing the transport of traffic with special requirements. QoS guarantees are important for applications that require fixed bit rate and are delay sensitive when the network capacity is insufficient. There are four major QoS factors to be considered when configuring a modern QoS implementation: bandwidth, delay, jitter and loss.

QoS provides better network service through the following features:

- Supporting dedicated bandwidth
- Improving loss characteristics
- Avoiding and managing network congestion
- Shaping network traffic
- Setting traffic priorities across the network

The Best-Effort service is the default QoS model in IP networks. It provides no guarantees for data delivering, which means delay, jitter, packet loss and bandwidth allocation are unpredictable. Differentiated Services (DiffServ or DS) is the most widely used QoS model. It provides a simple and scalable mechanism for classifying and managing network traffic and providing QoS on modern IP networks. Differentiated Services Code Point (DSCP) is used to define DiffServ classes and stored in the first six bits of the ToS (Type of Service) field. Each router on the network can provide QoS

simply based on the DiffServ class. The DSCP value ranges from 0 to 63 with each DSCP specifying a particular per-hop behavior (PHB) applicable to a packet. A PHB refers to the packet scheduling, queuing, policing, or shaping behavior of a node on any given packet.

Four standard PHBs available to construct a DiffServ-enabled network and achieve QoS:

- **Class Selector PHB** -- backwards compatible with IP precedence. Class Selector code points are of the form "xxx000". The first three bits are the IP precedence bits. These class selector PHBs retain almost the same forwarding behavior as nodes that implement IP precedence-based classification and forwarding.
- **Expedited Forwarding PHB** -- the key ingredient in DiffServ model for providing a low-loss, low-latency, low-jitter and assured bandwidth service.
- **Assured Forwarding PHB** -- defines a method by which BAs (Bandwidth Allocations) can be given different forwarding assurances.
- **Default PHB** -- specifies that a packet marked with a DSCP value of "000000" gets the traditional best effort service from a DS-compliant node.

VoIP is extremely bandwidth and delay-sensitive. QoS is a major issue in VoIP implementations, regarding how to guarantee that packet traffic not be delayed or dropped due to interference from other lower priority traffic. VoIP can guarantee high-quality QoS only if the voice and the SIP packets are given priority over other kinds of network traffic. IP phones support the DiffServ model of QoS.

Voice QoS

In order to make VoIP transmissions intelligible to receivers, voice packets should not be dropped, excessively delayed, or made to suffer varying delay. DiffServ model can guarantee high-quality voice transmission when the voice packets are configured to a higher DSCP value.

SIP QoS

SIP protocol is used for creating, modifying and terminating two-party or multi-party sessions. To ensure good voice quality, SIP packets emanated from IP phones should be configured with a high transmission priority.

DSCPs for voice and SIP packets can be specified respectively.

Procedure

QoS can be configured using the configuration files or locally.

<p>Configuration File</p>	<p><y0000000000xx>.cfg</p>	<p>Configure the DSCPs for voice packets and SIP packets.</p> <p>Parameters:</p>
----------------------------------	----------------------------------	---

		network.qos.rtplos network.qos.signallos
Local	Web User Interface	Configure the DSCPs for voice packets and SIP packets. Navigate to: http://<phoneIPAddress>/servlet?p=network-adv&q=load

Details of Configuration Parameters:

Parameters	Permitted Values	Default
network.qos.rtplos	Integer from 0 to 63	46
<p>Description: Configures the DSCP (Differentiated Services Code Point) for voice packets. The default DSCP value for RTP packets is 46 (Expedited Forwarding). Note: If you change this parameter, the IP phone will reboot to make the change take effect.</p> <p>Web User Interface: Network->Advanced->Voice QoS (0~63)</p> <p>Phone User Interface: None</p>		
network.qos.signallos	Integer from 0 to 63	26
<p>Description: Configures the DSCP (Differentiated Services Code Point) for SIP packets. The default DSCP value for SIP packets is 26 (Assured Forwarding). Note: If you change this parameter, the IP phone will reboot to make the change take effect.</p> <p>Web User Interface: Network->Advanced->SIP QoS (0~63)</p> <p>Phone User Interface: None</p>		

To configure DSCPs for voice packets and SIP packets via web user interface:

1. Click on **Network->Advanced**.
2. Enter the desired value in the **Voice QoS (0~63)** field.
3. Enter the desired value in the **SIP QoS (0~63)** field.

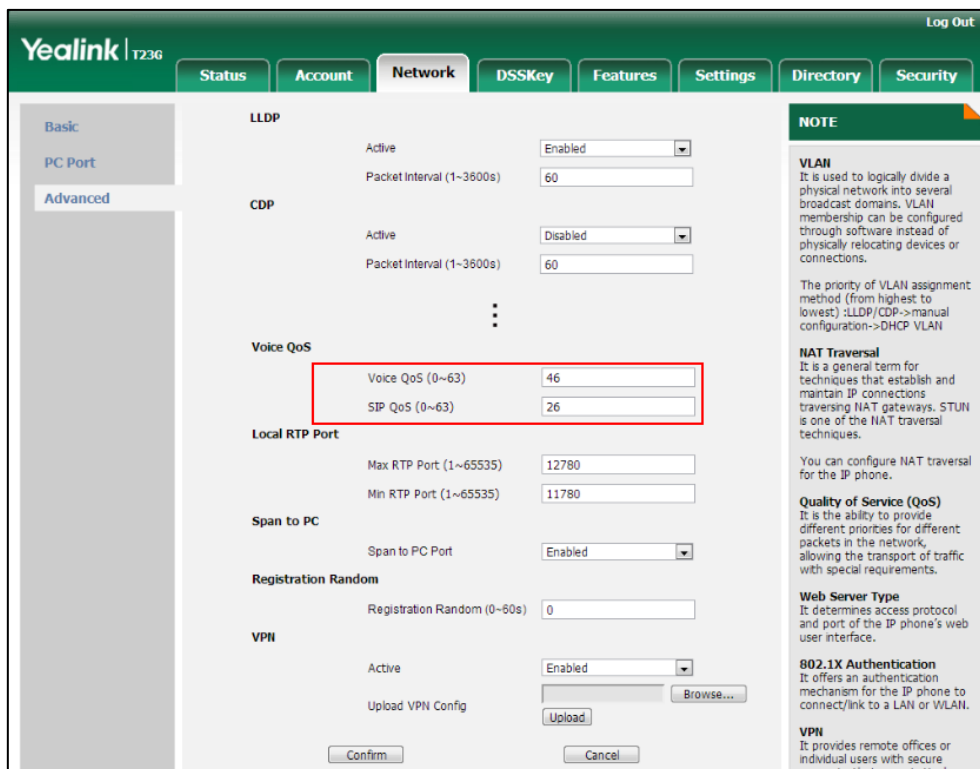

4. Click **Confirm** to accept the change.
A dialog box pops up to prompt that settings will take effect after a reboot.
5. Click **OK** to reboot the phone.

Network Address Translation

Network Address Translation (NAT) is essentially a translation table that maps public IP address and port combinations to private ones. This reduces the need for a large number of public IP addresses. NAT ensures security since each outgoing or incoming request must first go through a translation process.

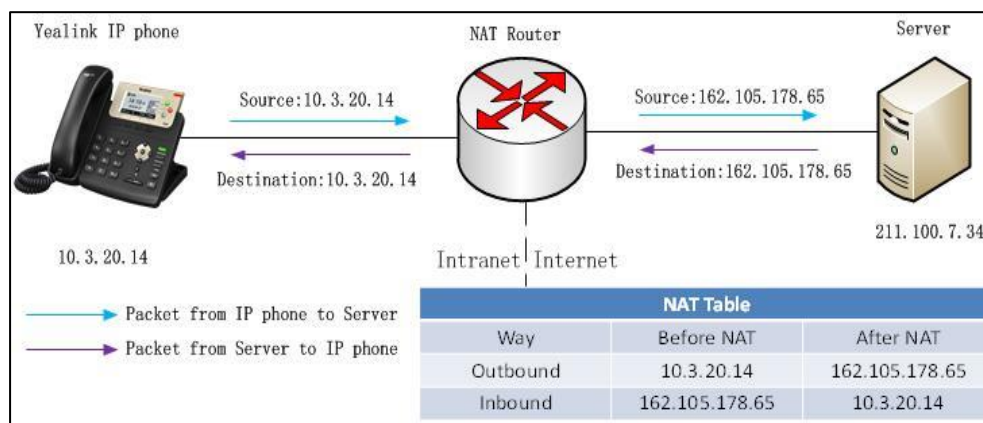

NAT Types

Symmetrical NAT

In symmetrical NAT, the NAT router stores the address and port where the packet was sent. Only packets coming from this address and port are forwarded back to the private address.

Full Cone NAT

In full cone NAT, all packets from a private address (e.g., iAddr: port1) to public network will be sent through a public address (e.g., eAddr: port2). Packets coming from the address of any server to eAddr: port2 will be forwarded back to the private address (e.g., iAddr: port1).

Address Restricted Cone NAT

Restricted cone NAT works similar like full cone NAT. A public host (hAddr: any) can send packets to iAddr: port1 through eAddr: port2 only if iAddr: port1 has previously sent a packet to hAddr: any. "Any" means the port number doesn't matter.

Port Restricted Cone NAT

Port restricted cone NAT works similar like full cone NAT. A public host (hAddr: hPort) can send packets to iAddr: port1 through eAddr: port2 only if iAddr: port1 has previously sent a packet to hAddr: hPort.

NAT Traversal

In the VoIP environment, NAT breaks end-to-end connectivity.

NAT traversal is a general term for techniques that establish and maintain IP connections traversing NAT gateways, typically required for client-to-client networking applications, especially for VoIP deployments. STUN is one of the NAT traversal techniques supported by IP phones.

STUN (Simple Traversal of UDP over NATs)

STUN is a network protocol, used in NAT traversal for applications of real-time voice, video, messaging, and other interactive IP communications. The STUN protocol allows applications to operate behind a NAT to discover the presence of the network address translator, and to obtain the mapped (public) IP address and port number that the NAT has allocated for the UDP connections to remote parties. The protocol requires assistance from a third-party network server (STUN server) usually located on public Internet. The IP phone can be configured to act as a STUN client, to send exploratory STUN messages to the STUN server. The STUN server uses those messages to determine the public IP address and port used, and then informs the client.

SIP and TLS Source Ports for NAT Traversal

You can configure the SIP and TLS source ports on the IP Phone. Previously, the IP phone used default values (5060 for UDP/TCP and 5061 for TLS). In the configuration files, you can use the following parameters to configure the SIP and TLS source ports:

- Local SIP Port
- TLS SIP Port

If NAT is disabled, the port number shows in the Via and Contact SIP headers of SIP messages. If NAT is enabled, the phone uses the NAT port number (and NAT IP address) in the Via and Contact SIP headers of SIP messages, but still use the configured source port.

Procedure

NAT traversal and STUN server can be configured using the configuration files or locally.

Configuration File	<y0000000000xx>.cfg	Configure NAT traversal and STUN server on a phone basis. Parameters: sip.nat_stun.enable sip.nat_stun.server sip.nat_stun.port Configure local SIP port and TLS
---------------------------	---------------------	--

		<p>SIP port.</p> <p>Parameters:</p> <p>sip.listen_port</p> <p>sip.tls_listen_port</p>
	<MAC>.cfg	<p>Configure NAT traversal on a per-line basis.</p> <p>Parameters:</p> <p>account.X.nat.nat_traversal</p>
Local	Web User Interface	<p>Configure NAT traversal and STUN server on a phone basis.</p> <p>Navigate to:</p> <p>http://<phoneIPAddress>/servlet? p=network-adv&q=load</p> <p>Configure local SIP port and TLS SIP port.</p> <p>Navigate to:</p> <p>http://<phoneIPAddress>/servlet?p=settings-sip&q=load</p> <p>Configure NAT traversal on a per-line basis.</p> <p>Navigate to:</p> <p>http://<phoneIPAddress>/servlet?p=account-register&q=load &acc=0</p>
	Phone User Interface	<p>Configure NAT traversal and STUN server on a phone basis.</p> <p>Configure NAT traversal on a per-line basis.</p>

Details of Configuration Parameters:

Parameters	Permitted Values	Default
sip.nat_stun.enable	0 or 1	0
<p>Description:</p> <p>Enables or disables the STUN (Simple Traversal of UDP over NATs) feature on the IP phone.</p> <p>0-Disabled</p>		

Parameters	Permitted Values	Default
<p>1-Enabled</p> <p>Note: If you change this parameter, the IP phone will reboot to make the change take effect.</p> <p>Web User Interface: Network->Advanced->NAT->Active</p> <p>Phone User Interface: Menu->Settings->Advanced Settings (default password: admin) ->Network->NAT->NAT Status</p>		
sip.nat_stun.server	IP address or domain name	Blank
<p>Description: Configures the IP address or the domain name of the STUN (Simple Traversal of UDP over NATs) server.</p> <p>Example: sip.nat_stun.server = 218.107.220.201</p> <p>Note: If you change this parameter, the IP phone will reboot to make the change take effect.</p> <p>Web User Interface: Network->Advanced->NAT->STUN Server</p> <p>Phone User Interface: Menu->Settings->Advanced Settings (default password: admin) ->Network->NAT->STUN Server</p>		
sip.nat_stun.port	Integer from 1024 to 65000	3478
<p>Description: Configures the port of the STUN (Simple Traversal of UDP over NATs) server.</p> <p>Example: sip.nat_stun.port = 3478</p> <p>Note: If you change this parameter, the IP phone will reboot to make the change take effect.</p> <p>Web User Interface: Network->Advanced->NAT->STUN Port(1024~65000)</p> <p>Phone User Interface: Menu->Settings->Advanced Settings (default password: admin)</p>		

Parameters	Permitted Values	Default
->Network->NAT->Port		
account.X.nat.nat_traversal	0 or 1	0
<p>Description: Enables or disables the NAT traversal for account X.</p> <p>0-Disabled 1-STUN</p> <p>Note: It works only if the value of the parameter "sip.nat_stun.enable" is set to 1 (Enabled).</p> <p>X ranges from 1 to 16 (for SIP-T48G/T46G/T29G) X ranges from 1 to 12 (for SIP-T42G) X ranges from 1 to 6 (for SIP-T41P/T27P) X ranges from 1 to 3 (for SIP-T23P/G) X ranges from 1 to 2 (for SIP-T21(P) E2) X is equal to 1 (for SIP-T19(P) E2)</p> <p>Web User Interface: Account->Register->NAT</p> <p>Phone User Interface: Menu->Settings->Advanced Settings->Accounts->AccountX->NAT Status</p>		
sip.listen_port	Integer from 1024 to 65535	5060
<p>Description: Configures the local SIP port.</p> <p>Web User Interface: Settings->SIP->Local SIP Port</p> <p>Phone User Interface: None</p>		
sip.tls_listen_port	Integer from 1024 to 65535	5061
<p>Description: Configures the local TLS listen port.</p> <p>Web User Interface: Settings->SIP->TLS SIP Port</p> <p>Phone User Interface:</p>		

Parameters	Permitted Values	Default
None		

To configure NAT traversal and STUN server via web user interface:

1. Click on **Network->Advanced**.
2. In the **NAT** block, select the desired value from the pull-down list of **Active**.
3. Enter the IP address or the domain name of the STUN server in the **STUN Server** field.
4. Enter the port of the STUN server in the **Port** field.

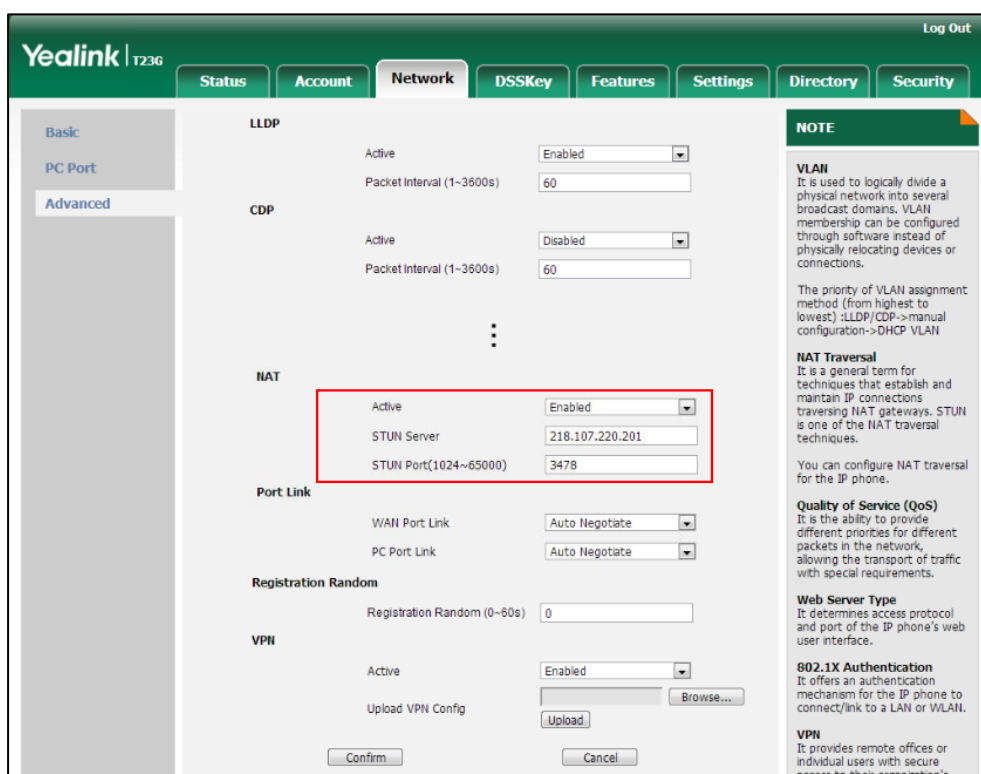

A dialog box pops up to prompt that settings will take effect after a reboot.

5. Click **Confirm** to accept the change.

To configure NAT traversal for account via web user interface:

1. Click on **Account->Register**.
2. Select the desired account from the pull-down list of **Account**.

3. Select **STUN** from the pull-down list of **NAT**.

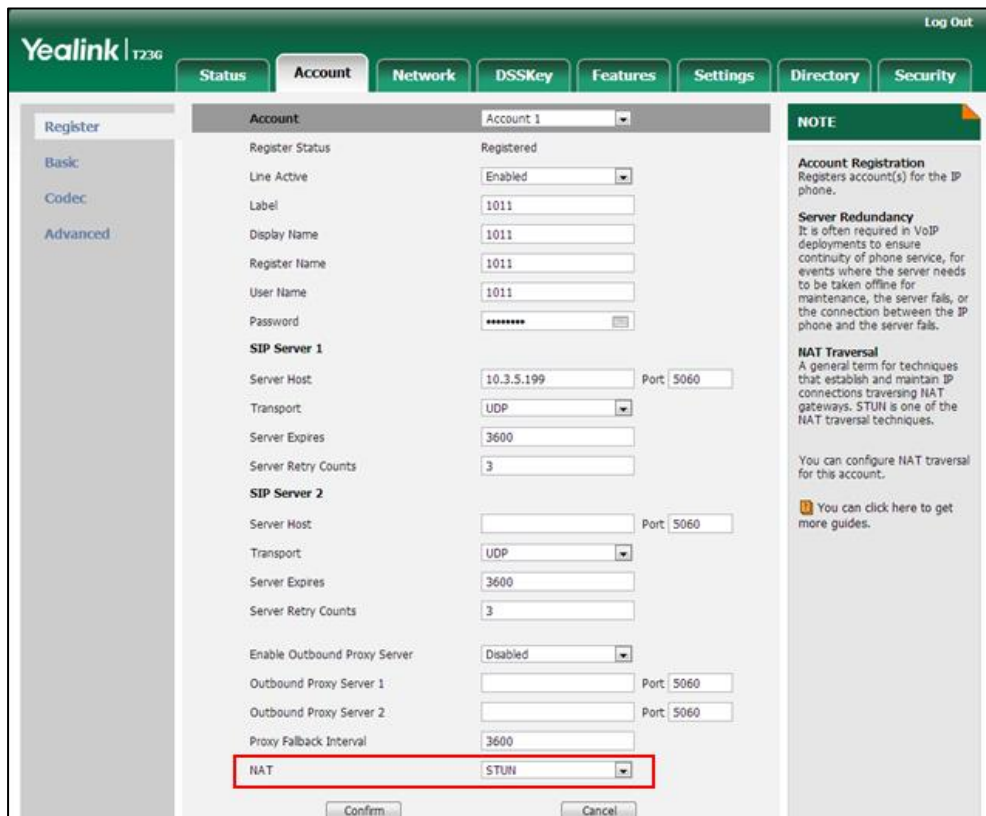

4. Click **Confirm** to accept the change.

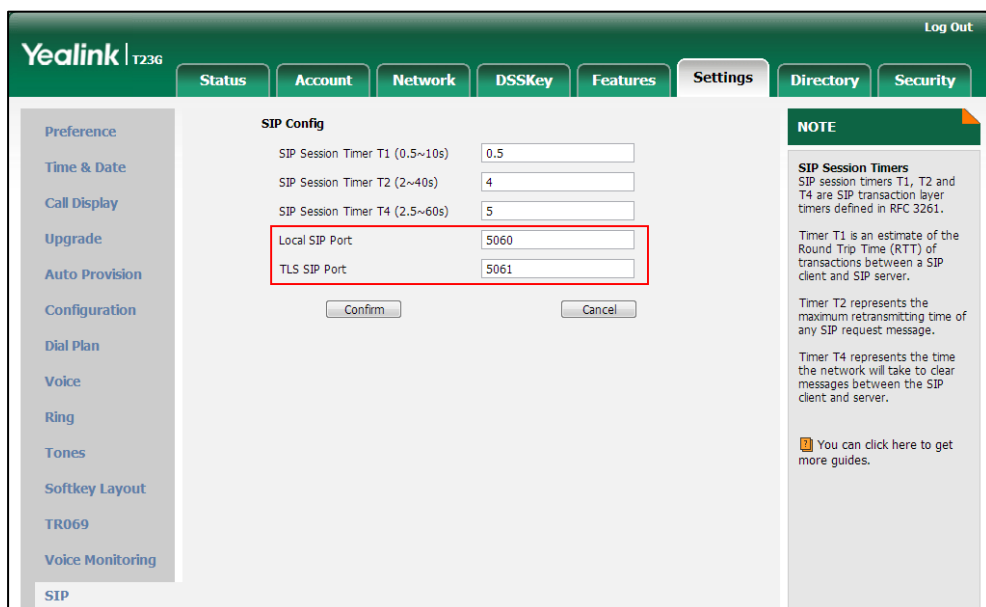

To configure local SIP port and TLS SIP port via web user interface:

1. Click on **Settings->SIP**.
2. Enter the desired local SIP port in the **Local SIP Port** field.
3. Enter the desired TLS SIP port in the **TLS SIP Port** field.







4. Click **Confirm** to accept the change.

To configure NAT traversal and STUN server via phone user interface:

1. Press **Menu->Settings->Advanced Settings** (default password: admin) ->**Network->NAT->NAT Status**.
2. Press  or , or the **Switch** soft key to select the desired value from the **NAT Status** field.
3. Enter the IP address or the domain name of the STUN server in the **STUN Server** field.
4. Enter the port of the STUN server in the **Port** field.
5. Press the **Save** soft key to accept the change.

The IP phone reboots automatically to make settings effective after a period of time.

To configure NAT traversal for a specific account via phone user interface:

1. Press **Menu->Settings->Advanced Settings** (default password: admin) ->**Accounts**.
2. Press  or  to select the desired account and press the **Enter** soft key.
3. Press  or , or the **Switch** soft key to select the desired value from the **NAT Status** field.
4. Press the **Save** soft key to accept the change.

The IP phone reboots automatically to make settings effective after a period of time.

Keep Alive

IP phones can send keep-alive packets to NAT device for keeping the communication port open.

Procedure

Keep alive feature can be configured using the configuration files or locally.

Configuration File	<MAC>.cfg	<p>Configure the type of keep-alive packets on a per-line basis.</p> <p>Parameters:</p> <p>account.X.nat.udp_update_enable</p> <p>Configure the keep-alive interval on a per-line basis.</p> <p>Parameters:</p> <p>account.X.nat.udp_update_time</p>
Local	Web User Interface	<p>Configure the type of keep-alive packets on a per-line basis.</p> <p>Configure the keep-alive interval</p>

		<p>on a per-line basis.</p> <p>Navigate to:</p> <p>http://<phoneIPAddress>/servlet?p=account-adv&q=load&acc=0</p>
--	--	--

Details of Configuration Parameters:

Parameters	Permitted Values	Default
account.X.nat.udp_update_enable	0, 1, 2 or 3	1
<p>Description:</p> <p>Configures the type of keep-alive packets sent by the IP phone to the NAT device to keep the communication port open so that NAT can continue to function for account X.</p> <p>0-Disabled</p> <p>1-Default (the IP phone sends UDP packets to the server)</p> <p>2-Options (the IP phone sends SIP OPTIONS packets to the server)</p> <p>3-Notify (the IP phone sends SIP NOTIFY packets to the server)</p> <p>X ranges from 1 to 16 (for SIPT48G/T46G/T29G)</p> <p>X ranges from 1 to 12 (for SIPT42G)</p> <p>X ranges from 1 to 6 (for SIPT41P/T27P)</p> <p>X ranges from 1 to 3 (for SIPT23P/G)</p> <p>X ranges from 1 to 2 (for SIPT21(P) E2)</p> <p>X is equal to 1 (for SIPT19(P) E2)</p> <p>Web User Interface:</p> <p>Account->Advanced->Keep Alive Type</p> <p>Phone User Interface:</p> <p>None</p>		
account.X.nat.udp_update_time	Integer from 15 to 2147483647	30
<p>Description:</p> <p>Configures the keep-alive interval (in seconds) for account X.</p> <p>X ranges from 1 to 16 (for SIPT48G/T46G/T29G)</p> <p>X ranges from 1 to 12 (for SIPT42G)</p> <p>X ranges from 1 to 6 (for SIPT41P/T27P)</p> <p>X ranges from 1 to 3 (for SIPT23P/G)</p> <p>X ranges from 1 to 2 (for SIPT21(P) E2)</p> <p>X is equal to 1 (for SIPT19(P) E2)</p>		

Parameters	Permitted Values	Default
<p>Example: account.1.nat.udp_update_time = 60</p> <p>Web User Interface: Account->Advanced->Keep Alive Interval(Seconds)</p> <p>Phone User Interface: None</p>		

To configure the type of keep-alive packets and keep-alive interval via web user interface:

1. Click on **Account->Advanced**.
2. Select the desired account from the pull-down list of **Account**.
3. Select the desired value from the pull-down list of **Keep Alive Type**.
4. Enter the keep-alive interval in the **Keep Alive Interval(Seconds)** field.

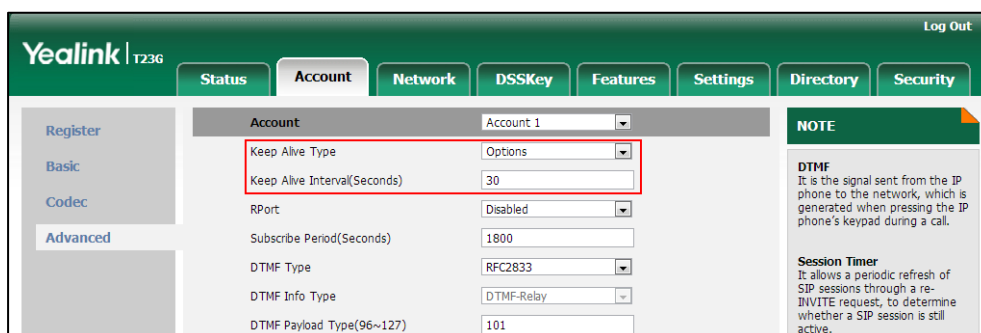

5. Click **Confirm** to accept the change.

Rport

Rport in [RFC 3581](#), allows a client to request that the server sends the response back to the source port from which the request came. Rport feature depends on support from a SIP server.

Procedure

Rport feature can be configured using the configuration files or locally.

Configuration File	<MAC>.cfg	Configure NAT Rport feature for account. Parameters: account.X.nat.rport
Local	Web User Interface	Configure NAT Rport feature for account.

		<p>Navigate to:</p> <p>http://<phoneIPAddress>/servlet?p =account-adv&q=load&acc=0</p>
--	--	---

Details of Configuration Parameters:

Parameters	Permitted Values	Default
account.X.nat.rport	0, 1 or 2	0
<p>Description: Enables or disables NAT Rport feature for account X. 0-Disabled 1-Enabled 2-enable direct process X ranges from 1 to 16 (for SIP-T48G/T46G/T29G) X ranges from 1 to 12 (for SIP-T42G) X ranges from 1 to 6 (for SIP-T41P/T27P) X ranges from 1 to 3 (for SIP-T23P/G) X ranges from 1 to 2 (for SIP-T21(P) E2) X is equal to 1 (for SIP-T19(P) E2)</p> <p>Web User Interface: Account->Advanced->RPort</p> <p>Phone User Interface: None</p>		

To configure Rport feature via web user interface:

1. Click on **Account->Advanced**.
2. Select the desired account from the pull-down list of **Account**.
3. Select the desired value from the pull-down list of **RPort**.

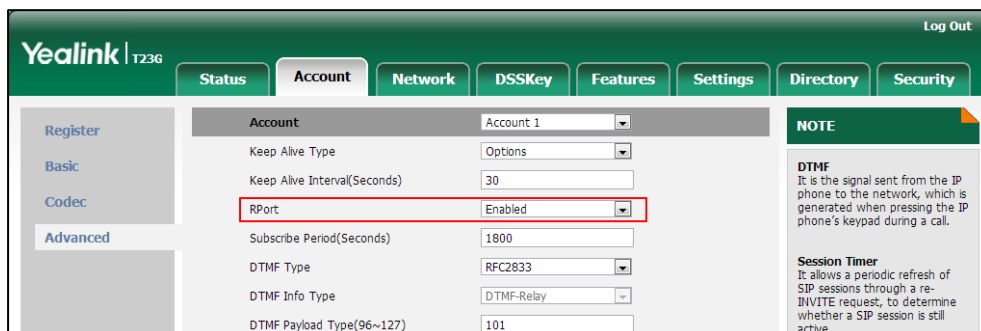

4. Click **Confirm** to accept the change.

Real-Time Transport Protocol

The Real-time Transport Protocol (RTP) is a network protocol for delivering audio and video over IP networks. The UDP port used for RTP streams is traditionally an even-numbered port. For example, the default RTP min port on the IP phones is 11780. The first voice patch sends RTP on port 11780. Additional calls would then use ports 11782, 11784, 11786, etc up to the max port.

Procedure

RTP port can be configured using the configuration files or locally.

Configuration File	<y0000000000xx>.cfg	Configure RTP port. Parameters: network.port.max_rtpport network.port.min_rtpport
Local	Web User Interface	Configure RTP port. Navigate to: http://<phoneIPAddress>/serv let?p=network-adv&q=load

Details of Configuration Parameters:

Parameters	Permitted Values	Default
network.port.max_rtpport	Integer from 1 to 65535	12780
<p>Description: Configures the maximum local RTP port.</p> <p>Note: The value of the maximum local RTP port cannot be less than that of the minimum local RTP port. If you change this parameter, the IP phone will reboot to make the change take effect.</p> <p>Web User Interface: Network->Advanced->Local RTP Port->Max RTP Port(1~65535)</p> <p>Phone User Interface: None</p>		
network.port.min_rtpport	Integer from 1 to 65535	11780
<p>Description: Configures the minimum local RTP port.</p>		

Parameters	Permitted Values	Default
<p>Note: If you change this parameter, the IP phone will reboot to make the change take effect.</p> <p>Web User Interface: Network->Advanced->Local RTP Port->Min RTP Port(1~65535)</p> <p>Phone User Interface: None</p>		

To configure the minimum and maximum RTP port via web user interface:

1. Click on **Network->Advanced**.
2. In the **Local RTP Port** block, enter the max and min RTP port in the **Max RTP Port(1~65535)** and **Min RTP Port(1~65535)** fields respectively.

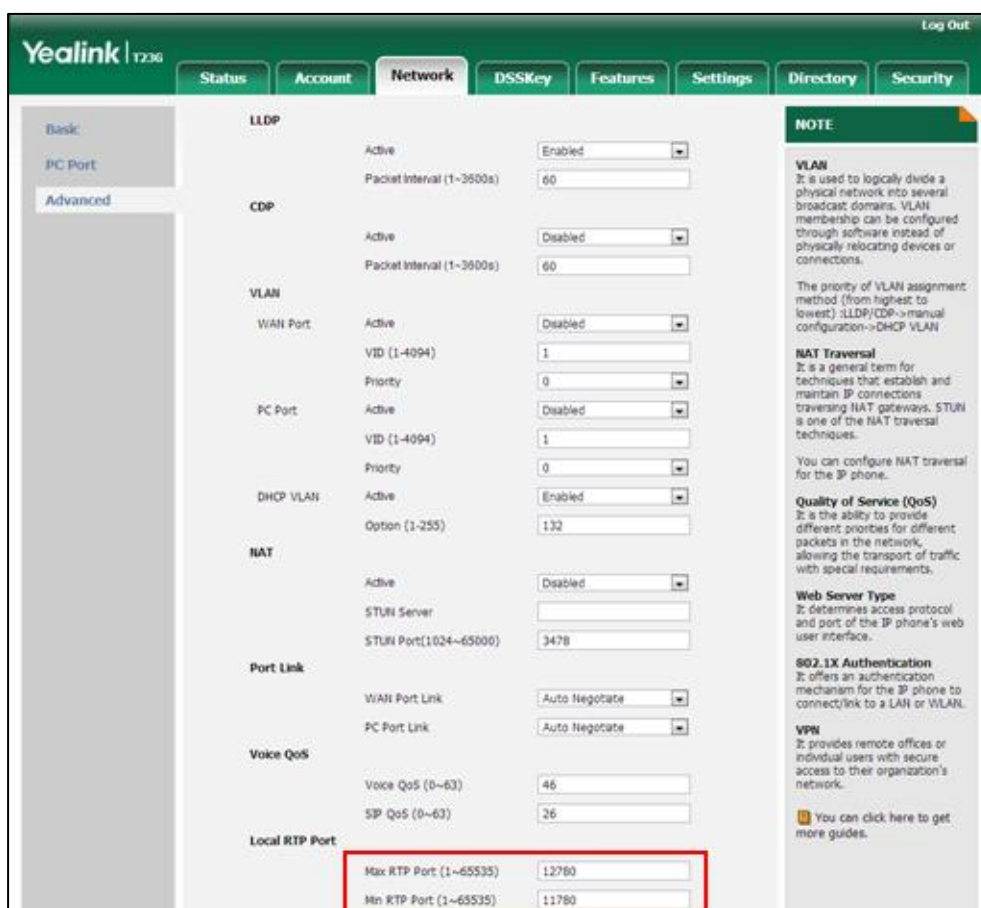

3. Click **Confirm** to accept the change.

TR-069 Device Management

TR-069 is a technical specification defined by the Broadband Forum, which defines a mechanism that encompasses secure auto-configuration of a CPE (Customer-Premises

Equipment), and incorporates other CPE management functions into a common framework. TR-069 uses common transport mechanisms (HTTP and HTTPS) for communication between CPE and ACS (Auto Configuration Servers). The HTTP(S) messages contain XML-RPC methods defined in the standard for configuration and management of the CPE.

TR-069 is intended to support a variety of functionalities to manage a collection of CPEs, including the following primary capabilities:

- Auto-configuration and dynamic service provisioning
- Software or firmware image management
- Status and performance monitoring
- Diagnostics

The following table provides a description of RPC methods supported by IP phones.

RPC Method	Description
GetRPCMethods	This method is used to discover the set of methods supported by the CPE.
SetParameterValues	This method is used to modify the value of one or more CPE parameters.
GetParameterValues	This method is used to obtain the value of one or more CPE parameters.
GetParameterNames	This method is used to discover the parameters accessible on a particular CPE.
GetParameterAttributes	This method is used to read the attributes associated with one or more CPE parameters.
SetParameterAttributes	This method is used to modify attributes associated with one or more CPE parameters.
Reboot	This method causes the CPE to reboot.
Download	This method is used to cause the CPE to download a specified file from the designated location. File types supported by IP phones are: <ul style="list-style-type: none"> • Firmware Image • Configuration File
Upload	This method is used to cause the CPE to upload a specified file to the designated location. File types supported by IP phones are: <ul style="list-style-type: none"> • Configuration File • Log File

RPC Method	Description
ScheduleInform	This method is used to request the CPE to schedule a one-time Inform method call (separate from its periodic Inform method calls) sometime in the future.
FactoryReset	This method resets the CPE to its factory default state.
TransferComplete	This method informs the ACS of the completion (either successful or unsuccessful) of a file transfer initiated by an earlier Download or Upload method call.
AddObject	This method is used to add a new instance of an object defined on the CPE.
DeleteObject	This method is used to remove a particular instance of an object.

For more information on TR-069, refer to [Yealink TR-069 Technote](#).

Procedure

TR-069 can be configured using the configuration files or locally.

Configuration File	<y00000000 00xx>.cfg	Configure TR-069 feature. Parameters: managementserver.enable managementserver.username managementserver.password managementserver.url managementserver.connection_request_username managementserver.connection_request_password managementserver.periodic_inform_enable managementserver.periodic_inform_interval
Local	Web User Interface	Configure TR-069 feature. Navigate to: http://<phoneIPAddress>/servlet?p=settings-tr069&q=load

Details of Configuration Parameters:

Parameters	Permitted Values	Default
managementserver.enable	0 or 1	0

Parameters	Permitted Values	Default
<p>Description: Enables or disables the TR-069 feature.</p> <p>0-Disabled 1-Enabled</p> <p>Web User Interface: Settings->TR069->Enable TR069</p> <p>Phone User Interface: None</p>		
managementserver.username	String within 128 characters	Blank
<p>Description: Configures the user name for the IP phone to authenticate with the ACS (Auto Configuration Servers). Leave it blank if no authentication is required.</p> <p>Example: managementserver.username = tr69</p> <p>Web User Interface: Settings->TR069->ACS Username</p> <p>Phone User Interface: None</p>		
managementserver.password	String within 64 characters	Blank
<p>Description: Configures the password for the IP phone to authenticate with the ACS (Auto Configuration Servers). Leave it blank if no authentication is required.</p> <p>Example: managementserver.password = tr69</p> <p>Web User Interface: Settings->TR069->ACS Password</p> <p>Phone User Interface: None</p>		
managementserver.url	URL within 511 characters	Blank

Parameters	Permitted Values	Default
<p>Description: Configures the access URL of the ACS (Auto Configuration Servers).</p> <p>Example: managementserver.url = http://officetelprov.orangero.net:8080/ftacs-digest/ACS</p> <p>Web User Interface: Settings->TR069->ACS URL</p> <p>Phone User Interface: None</p>		
managementserver.connection_request_username	String within 128 characters	Blank
<p>Description: Configures the user name for the IP phone to authenticate the incoming connection requests.</p> <p>Example: managementserver.connection_request_username = accuser</p> <p>Web User Interface: Settings->TR069->Connection Request Username</p> <p>Phone User Interface: None</p>		
managementserver.connection_request_password	String within 64 characters	Blank
<p>Description: Configures the password for the IP phone to authenticate the incoming connection requests.</p> <p>Example: managementserver.connection_request_password = acspwd</p> <p>Web User Interface: Settings->TR069->Connection Request Password</p> <p>Phone User Interface: None</p>		
managementserver.periodic_inform_enable	0 or 1	1

Parameters	Permitted Values	Default
<p>Description: Enables or disables the IP phone to periodically report its configuration information to the ACS (Auto Configuration Servers).</p> <p>0-Disabled 1-Enabled</p> <p>Web User Interface: Settings->TR069->Enable Periodic Inform</p> <p>Phone User Interface: None</p>		
<p>managementserver.periodic_inform_interval</p>	<p>Integer from 5 to 4294967295</p>	<p>60</p>
<p>Description: Configures the interval (in seconds) for the IP phone to report its configuration to the ACS (Auto Configuration Servers).</p> <p>Note: It works only if the value of the parameter "managementserver.periodic_inform_enable" is set to 1 (Enabled).</p> <p>Web User Interface: Settings->TR069->Periodic Inform Interval (seconds)</p> <p>Phone User Interface: None</p>		

To configure TR-069 via web user interface:

1. Click on **Settings->TR069**.
2. Select **Enabled** from the pull-down list of **Enable TR069**.
3. Enter the user name and password authenticated by the ACS in the **ACS Username** and **ACS Password** fields.
4. Enter the URL of the ACS in the **ACS URL** field.
5. Select the desired value from the pull-down list of **Enable Periodic Inform**.
6. Enter the desired time in the **Periodic Inform Interval (seconds)** field.

- Enter the user name and password authenticated by the IP phone in the **Connection Request Username** and **Connection Request Password** fields.

The screenshot shows the Yealink T23G web interface. The 'Settings' tab is selected, and the 'TR069' configuration page is displayed. A red box highlights the following fields: 'Enable TR069' (set to 'Enabled'), 'ACS Username', 'ACS Password', 'ACS URL', 'Enable Periodic Inform' (set to 'Enabled'), 'Periodic Inform Interval (seconds)' (set to '60'), 'Connection Request Username', and 'Connection Request Password'. Below these fields are 'Confirm' and 'Cancel' buttons. On the right, a 'NOTE' section titled 'TR-069 Device Management' explains that TR-069 is a technical specification defined by the Broadband Forum, which defines a mechanism that encompasses secure auto-configuration of a CPE (Customer-Premises Equipment), and incorporates other CPE management functions into a common framework. A link is provided to get more guides.

- Click **Confirm** to accept the change.

IPv6 Support

IPv6 is the next generation network layer protocol, designed as a replacement for the current IPv4 protocol. IPv6 is developed by the Internet Engineering Task Force (IETF) to deal with the long-anticipated problem of IPv4 address exhaustion. IPv6 uses a 128-bit address, consisting of eight groups of four hexadecimal digits separated by colons. VoIP network based on IPv6 can ensure QoS, a set of service requirements to deliver performance guarantee while transporting traffic over the network.

IPv6 Address Assignment Method

Supported IPv6 address assignment methods:

- Manual Assignment:** An IPv6 address and other configuration parameters (e.g., DNS server) for the IP phone can be statically configured by an administrator.
- Stateless Address Autoconfiguration (SLAAC):** SLAAC is one of the most convenient methods to assign IP addresses to IPv6 nodes. SLAAC requires no manual configuration of the IP phone, minimal (if any) configuration of routers, and no additional servers. To use IPv6 SLAAC, the IP phone must be connected to a network with at least one IPv6 router connected. This router is configured by the network administrator and sends out Router Advertisement announcements onto the link. These announcements can allow the on-link connected IP phone to configure itself with IPv6 address, as specified in RFC 4862.
- Stateful DHCPv6:** The Dynamic Host Configuration Protocol for IPv6 (DHCPv6) has been standardized by the IETF through RFC 3315. DHCPv6 enables DHCP servers to pass configuration parameters such as IPv6 network addresses to IPv6 nodes. It

offers the capability of automatic allocation of reusable network addresses and additional configuration flexibility. This protocol is a stateful counterpart to "IPv6 Stateless Address Autoconfiguration", and can be used separately or in addition to the stateless autoconfiguration to obtain configuration parameters.

Note

Stateful DHCPv6 address assignment method feature is only applicable to SIP-T48G/T46G/T29G IP phones.

If the IP phone enables the SLAAC and DHCPv6 features simultaneously, the IP phone will obtain the IP address via SLAAC and obtain other network parameters via DHCPv6.

Procedure

IPv6 can be configured using the configuration files or locally.

Configuration File	<MAC>.cfg	<p>Configure the IPv6 address assignment method.</p> <p>Parameters:</p> <ul style="list-style-type: none"> network.ip_address_mode network.ipv6_internet_port.type network.ipv6_internet_port.ip network.ipv6_prefix network.ipv6_internet_port.gateway network.ipv6_icmp_v6.enable <p>Configure the IPv6 static DNS address.</p> <p>Parameters:</p> <ul style="list-style-type: none"> network.ipv6_primary_dns network.ipv6_secondary_dns
	<y000000000xx>.cfg	<p>Configure the IPv6 static DNS.</p> <p>Parameter:</p> <ul style="list-style-type: none"> network.ipv6_static_dns_enable
Local	Web User Interface	<p>Configure the IPv6 address assignment method.</p> <p>Configure the IPv6 static DNS.</p> <p>Navigate to:</p> <p><a href="http://<phoneIPAddress>/servlet?parameter=network&q=load">http://<phoneIPAddress>/servlet?parameter=network&q=load</p>
	Phone User Interface	<p>Configure the IPv6 address assignment method.</p> <p>Configure the IPv6 static DNS.</p>

		Configure the IPv6 static DNS address.
--	--	--

Details of Configuration Parameters:

Parameters	Permitted Values	Default
network.ip_address_mode	0, 1 or 2	0
<p>Description: Configures the IP address mode.</p> <p>0-IPv4 1-IPv6 2-IPv4 & IPv6</p> <p>Note: If you change this parameter, the IP phone will reboot to make the change take effect.</p> <p>Web User Interface: Network->Basic->Internet Port->Mode (IPv4/IPv6)</p> <p>Phone User Interface: Menu->Settings->Advanced Settings (default password: admin) ->Network->WAN Port->IP Mode</p>		
network.ipv6_internet_port.type	0 or 1	0
<p>Description: Configures the Internet (WAN) port type for IPv6.</p> <p>0-DHCP 1-Static IP Address</p> <p>Note: It works only if the value of the parameter “network.ip_address_mode” is set to 1 (IPv6) or 2 (IPv4 & IPv6). If you change this parameter, the IP phone will reboot to make the change take effect.</p> <p>Web User Interface: Network->Basic->IPv6 Config</p> <p>Phone User Interface: Menu->Settings->Advanced Settings (default password: admin) ->Network->WAN Port->IPv6</p>		
network.ipv6_static_dns_enable	0 or 1	0
<p>Description:</p>		

Parameters	Permitted Values	Default
<p>Triggers the static IPv6 DNS feature to on or off.</p> <p>0-Off</p> <p>1-On</p> <p>If it is set to 0 (Off), the IP phone will use the IPv6 DNS obtained from DHCP.</p> <p>If it is set to 1 (On), the IP phone will use manually configured static IPv6 DNS.</p> <p>Note: It works only if the value of the parameter "network.ipv6_internet_port.type" is set to 0 (DHCP). If you change this parameter, the IP phone will reboot to make the change take effect.</p> <p>Web User Interface: Network->Basic->IPv6 Config->IPv6 Static DNS</p> <p>Phone User Interface: Menu->Settings->Advanced Settings (default: admin) ->Network->WAN Port->IPv6->DHCP IPv6 Client->Static DNS</p>		
network.ipv6_internet_port.ip	IPv6 address	Blank
<p>Description: Configures the IPv6 address.</p> <p>Example: network.ipv6_internet_port.ip = 2026:1234:1:1:215:65ff:fe1f:caa</p> <p>Note: It works only if the value of the parameter "network.ip_address_mode" is set to 1 (IPv6) or 2 (IPv4 & IPv6), and "network.ipv6_internet_port.type" is set to 1 (Static IP Address). If you change this parameter, the IP phone will reboot to make the change take effect.</p> <p>Web User Interface: Network->Basic->IPv6 Config->Static IP Address->IP Address</p> <p>Phone User Interface: Menu->Settings->Advanced Settings (default password: admin) ->Network->WAN Port->IPv6->Static IPv6 Client->IPv6 IP</p>		
network.ipv6_prefix	Integer from 0 to 128	64
<p>Description: Configures the IPv6 prefix.</p> <p>Note: It works only if the value of the parameter "network.ip_address_mode" is set to 1 (IPv6) or 2 (IPv4 & IPv6), and "network.ipv6_internet_port.type" is set to 1 (Static IP Address). If you change this parameter, the IP phone will reboot to make the</p>		

Parameters	Permitted Values	Default
<p>change take effect.</p> <p>Web User Interface: Network->Basic->IPv6 Config->Static IP Address->IPv6 Prefix(0~128)</p> <p>Phone User Interface: Menu->Settings->Advanced Settings (default password: admin) ->Network->WAN Port->IPv6->Static IPv6 Client->IPv6 IP Prefix</p>		
network.ipv6_internet_port.gateway	IPv6 address	Blank
<p>Description: Configures the IPv6 default gateway.</p> <p>Example: network.ipv6_internet_port.gateway = 3036:1:1:c3c7:c11c:5447:23a6:255</p> <p>Note: It works only if the value of the parameter "network.ip_address_mode" is set to 1 (IPv6) or 2 (IPv4 & IPv6), and "network.ipv6_internet_port.type" is set to 1 (Static IP Address). If you change this parameter, the IP phone will reboot to make the change take effect.</p> <p>Web User Interface: Network->Basic->IPv6 Config->Static IP Address->Gateway</p> <p>Phone User Interface: Menu->Settings->Advanced Settings (default password: admin) ->Network->WAN Port->IPv6->Static IPv6 Client->IPv6 Default Gateway</p>		
network.ipv6_primary_dns	IPv6 address	Blank
<p>Description: Configures the primary IPv6 DNS server.</p> <p>Example: network.ipv6_primary_dns = 3036:1:1:c3c7:c11c:5447:23a6:256</p> <p>Note: It works only if the value of the parameter "network.ip_address_mode" is set to 1 (IPv6) or 2 (IPv4 & IPv6). In DHCP environment, you also need to make sure the value of the parameter "network.ipv6_static_dns_enable" is set to 1 (On). If you change this parameter, the IP phone will reboot to make the change take effect.</p> <p>Web User Interface: Network->Basic->IPv6 Config->Static IP Address->Primary DNS</p> <p>Phone User Interface: Menu->Settings->Advanced Settings (default password: admin)</p>		

Parameters	Permitted Values	Default
<p>->Network->WAN Port->IPv6->Static IPv6 Client->IPv6 Pri.DNS</p> <p>Or Menu->Settings->Advanced Settings (default password: admin)</p> <p>->Network->WAN Port->IPv6->DHCP IPv6 Client->Staic DNS(Enabled) ->IPv6 Pri.DNS</p>		
network.ipv6_secondary_dns	IPv6 address	Blank
<p>Description: Configures the secondary IPv6 DNS server.</p> <p>Example: network.ipv6_secondary_dns = 2026:1234:1:1:c3c7:c11c:5447:23a6</p> <p>Note: It works only if the value of the parameter "network.ip_address_mode" is set to 1 (IPv6) or 2 (IPv4 & IPv6). In DHCP environment, you also need to make sure the value of the parameter "network.ipv6_static_dns_enable" is set to 1 (On). If you change this parameter, the IP phone will reboot to make the change take effect.</p> <p>Web User Interface: Network->Basic->IPv6 Config->Static IP Address->Secondary DNS</p> <p>Phone User Interface: Menu->Settings->Advanced Settings (default password: admin) ->Network->WAN Port->IPv6->Static IPv6 Client->IPv6 Sec.DNS</p> <p>Or Menu->Settings->Advanced Settings (default password: admin) ->Network->WAN Port->IPv6->DHCP IPv6 Client->Staic DNS(Enabled) ->IPv6 Sec.DNS</p>		
network.ipv6_icmp_v6.enable	0 or 1	1
<p>Description: Enables or disables the IP phone to obtain IPv6 network settings via SLAAC (Stateless Address Autoconfiguration) method.</p> <p>0-Disabled 1-Enabled</p> <p>Note: If you change this parameter, the IP phone will reboot to make the change take effect. It is only applicable to SIP-T48G/T46G/T29G IP phones. SLAAC is enabled on SIP-T42G/T41P/T27P/T23P/T23G/T21(P) E2/T19(P) E2 IP phones by default. You are not allowed to configure this parameter for those IP phones.</p> <p>Web User Interface: Network->Advanced->ICMPv6 Status->Active</p> <p>Phone User Interface:</p>		

Parameters	Permitted Values	Default
None		

To configure IPv6 address assignment method via web user interface:

1. Click on **Network->Basic**.
2. Select the desired address mode (IPv6 or IPv4 & IPv6) from the pull-down list of **Mode(IPv4/IPv6)**.
3. In the **IPv6 Config** block, mark the **DHCP** or the **Static IP Address** radio box.
 - If you mark the **Static IP Address** radio box, configure the IPv6 address and other configuration parameters in the corresponding fields.

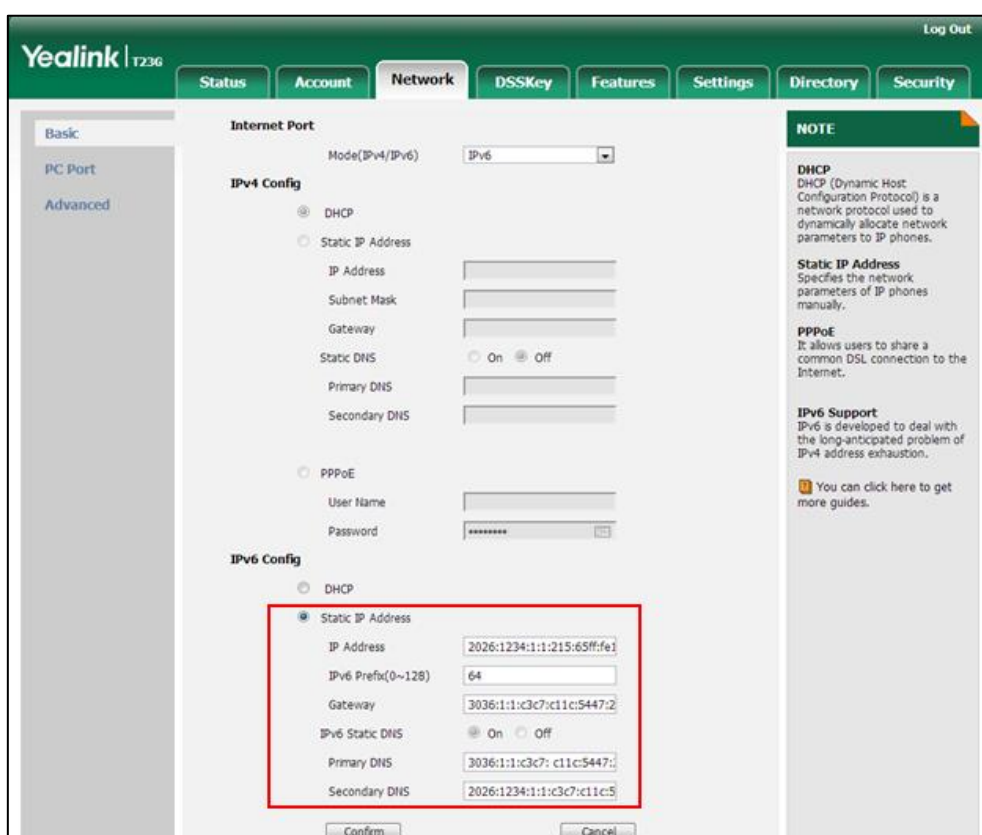

- (Optional.) If you mark the **DHCP** radio box, you can configure the static DNS address in the corresponding fields.

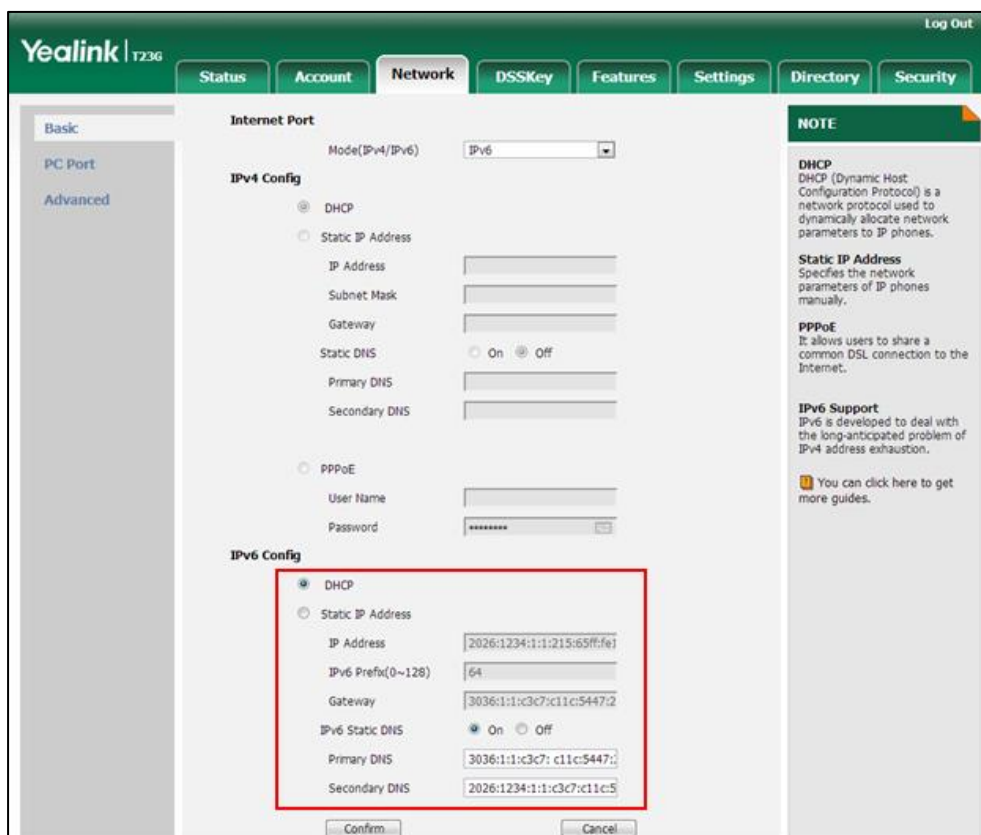

4. Click **Confirm** to accept the change.
A dialog box pops up to prompt that the settings will take effect after a reboot.
5. Click **OK** to reboot the phone.

To configure SLAAC feature via web user interface (only applicable to SIP-T48G/T46G/T29G):

1. Click on **Network->Advanced**.

- In the **ICMPv6 Status** block, select the desired value from the pull-down list of **Active**.

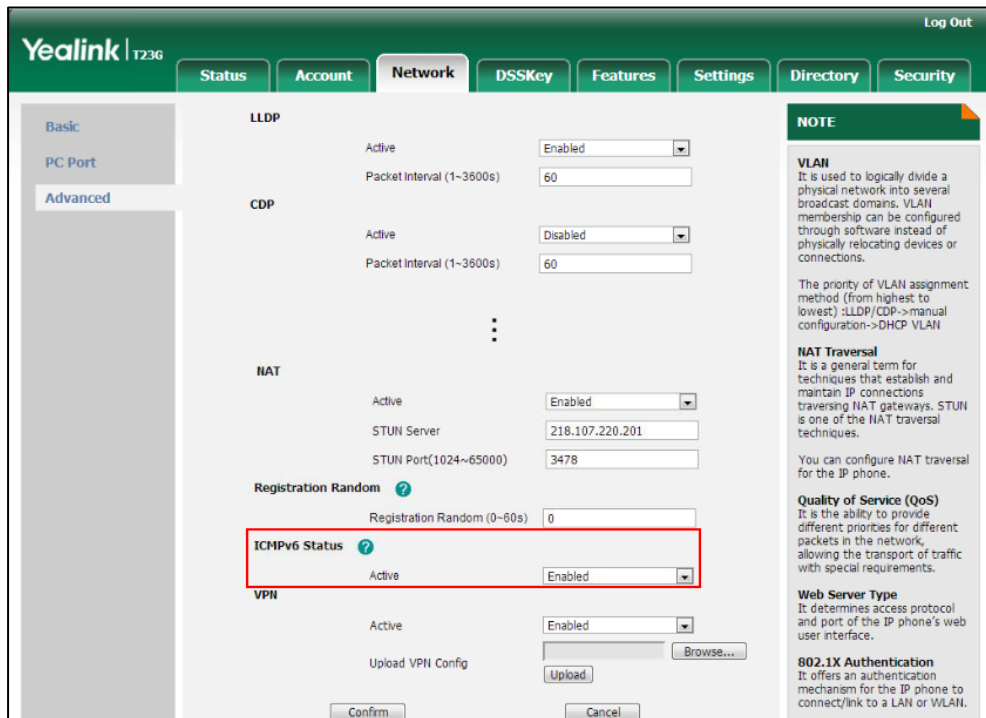

- Click **Confirm** to accept the change.

To configure IPv6 address assignment method via phone user interface:

- Press **Menu->Settings->Advanced Settings (default password: admin) ->Network->WAN Port**.
- Press **◀** or **▶** to select **IPv4 & IPv6** or **IPv6** from the **IP Mode** field.
- Press **▲** or **▼** to highlight **IPv6** and press the **Enter** soft key.
- Press **▲** or **▼** to select the desired IPv6 address assignment method.

If you select the **Static IPv6 Client**, configure the IPv6 address and other network parameters in the corresponding fields.

- Press the **Save** soft key to accept the change.

The IP phone reboots automatically to make settings effective after a period of time.

To configure static DNS when DHCP is used via phone user interface:

- Press **Menu->Settings->Advanced Settings (default password: admin) ->Network->WAN Port->IPv6->DHCP IPv6 Client**.
- Press **◀** or **▶**, or the **Switch** soft key to select **Enabled** from the **Static DNS** field.
- Enter the desired values in the **IPv6 Pri.DNS** and **IPv6 Sec.DNS** fields respectively.
- Press the **Save** soft key to accept the change.

The IP phone reboots automatically to make settings effective after a period of time.

Configuring Audio Features

This chapter provides information for making configuration changes for the following audio features:

- [Ring Tones](#)
- [Distinctive Ring Tones](#)
- [Tones](#)
- [Voice Mail Tone](#)
- [Headset Prior](#)
- [Dual Headset](#)
- [Sending Volume](#)
- [Audio Codecs](#)
- [Acoustic Clarity Technology](#)

Ring Tones

Ring tones are used to indicate incoming calls acoustically. Users can select a built-in system ring tone or a custom ring tone for the phone or account. To set the custom ring tones, you need to upload the custom ring tones to the IP phone in advance.

The ring tone format must meet the following:

Phone Model	Format	Single File Size	Total File Size
SIP-T48G/T46G/T29G	.wav	<=8MB	<=20MB
SIP-T42G/T41P/T27P/T23P/T23G/ T21(P) E2/T19(P) E2	.wav	<=100KB	<=100KB

Note The ring tone file must be PCMU audio format, mono channel, 8K sample rate and 16 bit resolution.

Procedure

Ring tones can be configured using the configuration files or locally.

Configuration File	<y0000000000xx>.cfg	Configure a ring tone for the IP phone. Parameter: phone_setting.ring_type
---------------------------	---------------------	---

		<p>Specify the access URL of the custom ring tone.</p> <p>Parameter: ringtone.url</p> <p>Delete all custom ring tone files.</p> <p>Parameter: ringtone.delete</p>
	<MAC>.cfg	<p>Configure a ring tone on a per-line basis.</p> <p>Parameters: account.X.ringtone.ring_type</p>
Local	Web User Interface	<p>Upload the custom ring tones.</p> <p>Configure a ring tone for the IP phone.</p> <p>Navigate to: http://<phoneIPAddress>/servlet?p=settings-preference&q=load</p> <p>Configure a ring tone on a per-line basis.</p> <p>Navigate to: http://<phoneIPAddress>/servlet?p=account-basic&q=load&acc=0</p>
	Phone User Interface	<p>Configure the ring tone for the IP phone.</p> <p>Configure a ring tone for the account.</p>

Details of the Configuration Parameter:

Parameters	Permitted Values	Default
phone_setting.ring_type	Refer to the following content	Ring1.wav
<p>Description: Configures a ring tone for the IP phone.</p> <p>Example:</p>		

Parameters	Permitted Values	Default
<p>To configure a phone built-in ring tone (e.g., Ring1.wav): phone_setting.ring_type = Ring1.wav</p> <p>To configure a custom ring tone (e.g., Customring.wav): phone_setting.ring_type = Customring.wav</p> <p>Permitted Values:</p> <p>Ring1.wav, Ring2.wav, Ring3.wav, Ring4.wav, Ring5.wav, Ring6.wav, Ring7.wav, Ring8.wav, Silent.wav, Splash.wav or custom ring tone name (e.g., Customring.wav).</p> <p>Web User Interface:</p> <p>Settings->Preference->Ring Type</p> <p>Phone User Interface:</p> <p>Menu->Settings->Basic Settings->Sound->Ring Tones->Common</p>		
account.X.ringtone.ring_type	Refer to the following content	Common
<p>Description:</p> <p>Configures a ring tone for account X.</p> <p>Example:</p> <p>account.1.ringtone.ring_type = Ring3.wav</p> <p>It means configuring Ring3.wav for account1.</p> <p>account.1.ringtone.ring_type = Common</p> <p>It means account1 will use the ring tone selected for the IP phone configured by the parameter "phone_setting.ring_type".</p> <p>Permitted Values:</p> <p>Common, Ring1.wav, Ring2.wav, Ring3.wav, Ring4.wav, Ring5.wav, Ring6.wav, Ring7.wav, Ring8.wav, Silent.wav, Splash.wav or custom ring tone name (e.g., Customring.wav).</p> <p>X ranges from 1 to 16 (for SIP-T48G/T46G/T29G)</p> <p>X ranges from 1 to 12 (for SIP-T42G)</p> <p>X ranges from 1 to 6 (for SIP-T41P/T27P)</p> <p>X ranges from 1 to 3 (for SIP-T23P/G)</p> <p>X ranges from 1 to 2 (for SIP-T21(P) E2)</p> <p>X is equal to 1 (for SIP-T19(P) E2)</p> <p>Web User Interface:</p> <p>Account->Basic->Ring Type</p> <p>Phone User Interface:</p> <p>Menu->Settings->Basic Settings->Sound->Ring Tones->Account X</p>		

Parameters	Permitted Values	Default
ringtone.url	URL within 511 characters	Blank
<p>Description: Configures the access URL of the custom ring tone file.</p> <p>Example: ringtone.url = tftp://192.168.1.100/Customring.wav</p> <p>Web User Interface: Settings->Preference->Upload Ringtone</p> <p>Phone User Interface: None</p>		
ringtone.delete	http://localhost/all	Blank
<p>Description: Delete all custom ring tone files.</p> <p>Example: ringtone.delete = http://localhost/all</p> <p>Web User Interface: None</p> <p>Phone User Interface: None</p>		

To upload a custom ring tone via web user interface:

1. Click on **Settings->Preference**.
2. In the **Upload Ringtone** field, click **Browse** to locate a ring tone file (the file format must be *.wav) from your local system.
3. Click **Upload** to upload the file.

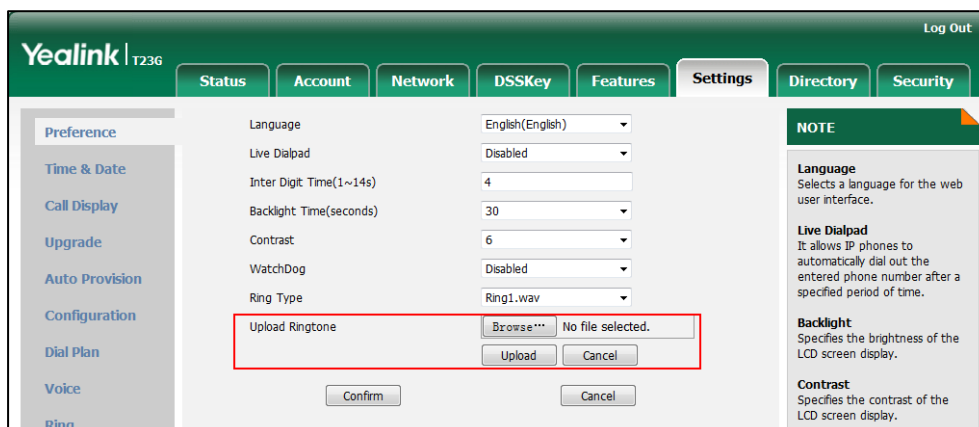

The custom ring tone appears in the pull-down list of **Ring Type**.

To change the ring tone for the phone via web user interface:

1. Click on **Settings->Preference**.
2. Select the desired ring tone from the pull-down list of **Ring Type**.

The screenshot shows the Yealink T236 web interface. The 'Settings' tab is active, and the 'Preference' sub-tab is selected. The 'Ring Type' dropdown menu is highlighted with a red box and set to 'Ring1.wav'. The 'Upload Ringtone' section shows a 'Browse...' button and 'Upload' and 'Cancel' buttons. A 'Confirm' button is at the bottom. A 'NOTE' section on the right provides details for Language, Live Dialpad, Backlight, and Contrast settings.

3. Click **Confirm** to accept the change.

To change the ring tone for the account via web user interface:

1. Click on **Account->Basic**.
2. Select the desired account from the pull-down list of **Account**.
3. Select the desired ring tone from the pull-down list of **Ring Type**.





The screenshot shows the Yealink T236 web interface. The 'Account' tab is active, and the 'Basic' sub-tab is selected. The 'Ring Type' dropdown menu is highlighted with a red box and set to 'Common'. The 'Account' dropdown menu is set to 'Account 1'. The 'Confirm' and 'Cancel' buttons are visible at the bottom. A 'NOTE' section on the right provides details for Anonymous Call and Anonymous Call Rejection settings.

4. Click **Confirm** to accept the change.

To select a ring tone for the phone via phone user interface:

1. Press **Menu->Settings->Basic Settings->Sound->Ring Tones->Common**.
2. Press **▲** or **▼** to select the desired ring tone.
3. Press the **Save** soft key to accept the change or the **Back** soft key to cancel.

To select a ring tone for the account via phone user interface:

1. Press **Menu->Settings->Basic Settings->Sound->Ring Tones**.
2. Press  or  to select the desired account and then press the **Enter** soft key.
3. Press  or  to select the desired ring tone.
If **Common** is selected, this account will use the ring tone selected for the phone.
4. Press the **Save** soft key to accept the change or the **Back** soft key to cancel.

Distinctive Ring Tones

Distinctive ring tones allows certain incoming calls to trigger IP phones to play distinctive ring tones. The IP phone inspects the INVITE request for an "Alert-Info" header when receiving an incoming call. If the INVITE request contains an "Alert-Info" header, the IP phone strips out the URL or keyword parameter and maps it to the appropriate ring tone.

Note

If the caller already exists in the local directory, the ring tone assigned to the caller should be preferentially played.

Alert-Info headers in the following four formats:

Alert-Info: 127.0.0.1/Bellcore-drN (or Alert-Info: Bellcore-drN)

Alert-Info: ringtone-N (or Alert-Info: MyMelodyN)

Alert-Info: <URL>

Alert-Info: info=info text;x-line-id=0

- When the Alter-Info header contains the keyword "Bellcore-drN", the IP phone will play the Bellcore-drN (N=1, 2, 3, 4 or 5) ring tone if the value of the parameter "features.alert_info_tone" is set to 1, or play the corresponding local ring tone (RingN.wav) in about 10 seconds if the value of the parameter "features.alert_info_tone" is set to 0.

Example:

Alert-Info: http://127.0.0.1/Bellcore-dr1

The following table identifies the different Bellcore ring tone patterns and cadences (These ring tones are designed for the BroadWorks server).

Bellcore Tone	Pattern ID	Pattern	Cade nce	Minimum Duration (ms)	Nominal Duration (ms)	Maximum Duration (ms)
Bellcore-dr1 (standard)	1	Ringing		1800	2000	2200
		Silent		3600	4000	4400
Bellcore-dr2	2	Ringing	Long	630	800	1025
		Silent		315	400	525

Bellcore Tone	Pattern ID	Pattern	Cadence	Minimum Duration (ms)	Nominal Duration (ms)	Maximum Duration (ms)
		Ring	Long	630	800	1025
		Silent		3475	4000	4400
Bellcore-dr3	3	Ring	Short	315	400	525
		Silent		145	200	525
		Ring	Short	315	400	525
		Silent		145	200	525
		Ring	Long	630	800	1025
		Silent		2975	4000	4400
Bellcore-dr4	4	Ring	Short	200	300	525
		Silent		145	200	525
		Ring	Long	800	1000	1100
		Silent		145	200	525
		Ring	Short	200	300	525
		Silent		2975	4000	4400
Bellcore-dr5	5	Ring		450	500	550

Note “Bellcore-dr5” is a ring splash tone that reminds the user that the DND or Always Call Forward feature is enabled on the server side.

- When the Alter-Info header contains the keyword “ringtone-N” or “MyMelodyN”, the IP phone will play the corresponding local ring tone (RingN.wav), or play the first local ring tone (Ring1.wav) in about 10 seconds if “N” is greater than 10 or less than 1.

Example:

Alert-Info: ringtone-2

Alert-Info: MyMelody2

The following table identifies the corresponding local ring tone:

Value of N	Ring Tone
1	Ring1.wav
2	Ring2.wav
3	Ring3.wav

Value of N	Ring Tone
4	Ring4.wav
5	Ring5.wav
6	Ring6.wav
7	Ring7.wav
8	Ring8.wav
9	Silent.wav
10	Splash.wav
N<1 or N>10	Ring1.wav

- When the Alert-Info header contains a remote URL, the IP phone will try to download the WAV ring tone file from the URL and then play the remote ring tone if the value of the parameter "account.X.alert_info_url_enable" is set to 1 (or the item called "Distinctive Ring Tones" on the web user interface is Enabled), or play the preconfigured local ring tone in about 10 seconds if the value of the parameter "account.X.alert_info_url_enable" is set to 0 or if the IP phone fails to download the remote ring tone.

Example:

Alert-Info: http://192.168.0.12:8080/Custom.wav

- When the Alert-Info header contains an info text, the IP phone will map the text with the internal ringer text preconfigured on the IP phone, and then play the ring tone associated with the internal ringer text. If no internal ringer text maps, the IP phone will play the preconfigured local ring tone in about 10 seconds.

Example:

Alert-Info: info=family;x-line-id=0

Auto Answer

If the Alert-Info header contains the following type of strings, the IP phone will answer incoming calls automatically without playing the ring tone:

- Alert-Info: Auto Answer
- Alert-Info: info = alert-autoanswer
- Alert-Info: answer-after = 0 (or Alert-Info: Answer-After = 0)

Note

If the Alert-Info header contains multiple types of keywords, the IP phone will process the keywords in the following order:
AutoAnswer>URL>"Bellcore-drN/ringtone-N/MyMelodyN">info text.

Procedure

Distinctive ring tones can be configured using the configuration files or locally.

Configuration File	<MAC>.cfg	Configure distinctive ring tones. Parameter: account.X.alert_info_url_enable
	<y0000000000xx>.cfg	Configure the internal ringer text and internal ringer file. Parameters: features.alert_info_tone distinctive_ring_tones.alert_info.X.text distinctive_ring_tones.alert_info.X.ringer
Local	Web User Interface	Configure distinctive ring tones. Navigate to: http://<phoneIPAddress>/servlet?p=account-adv&q=load&acc=0 Configure the internal ringer text and internal ringer file. Navigate to: http://<phoneIPAddress>/servlet?p=settings-ring&q=load

Details of Configuration Parameters:

Parameters	Permitted Values	Default
account.X.alert_info_url_enable	0 or 1	1
<p>Description: Enables or disables the IP phone to download the ring tone from the URL contained in the Alert-Info header for account X.</p> <p>0-Disabled 1-Enabled</p> <p>X ranges from 1 to 16 (for SIP-T48G/T46G/T29G) X ranges from 1 to 12 (for SIP-T42G) X ranges from 1 to 6 (for SIP-T41P/T27P)</p>		

Parameters	Permitted Values	Default
<p>X ranges from 1 to 3 (for SIP-T23P/G) X ranges from 1 to 2 (for SIP-T21(P) E2) X is equal to 1 (for SIP-T19(P) E2)</p> <p>Web User Interface: Account->Advanced->Distinctive Ring Tones</p> <p>Phone User Interface: None</p>		
features.alert_info_tone	0 or 1	0
<p>Description: Enables or disables the IP phone to map the keywords in the Alert-info header to the specified Bellcore ring tones.</p> <p>0-Disabled 1-Enabled</p> <p>Web User Interface: None</p> <p>Phone User Interface: None</p>		
distinctive_ring_tones.alert_info.X.text (X ranges from 1 to 10)	String within 32 characters	Blank
<p>Description: Configures the internal ringer text to map the keywords contained in the Alert-Info header.</p> <p>Example: distinctive_ring_tones.alert_info.1.text = Family</p> <p>Web User Interface: Settings->Ring->Internal Ringer Text</p> <p>Phone User Interface: None</p>		
distinctive_ring_tones.alert_info.X.ringer (X ranges from 1 to 10)	Integer from 1 to 10	1
<p>Description: Configures the desired ring tones for each internal ringer text. The value ranges from 1 to 10, the digit stands for the appropriate ring tone.</p>		

Parameters	Permitted Values	Default
1-Ring1.wav		
2-Ring2.wav		
3-Ring3.wav		
4-Ring4.wav		
5-Ring5.wav		
6-Ring6.wav		
7-Ring7.wav		
8-Ring8.wav		
9-Silent.wav		
10-Splash.wav		
Web User Interface:		
Settings->Ring->Internal Ringer File		
Phone User Interface:		
None		

To configure distinctive ring tones via web user interface:

1. Click on **Account->Advanced**.
2. Select the desired account from the pull-down list of **Account**.
3. Select the desired value from the pull-down list of **Distinctive Ring Tones**.

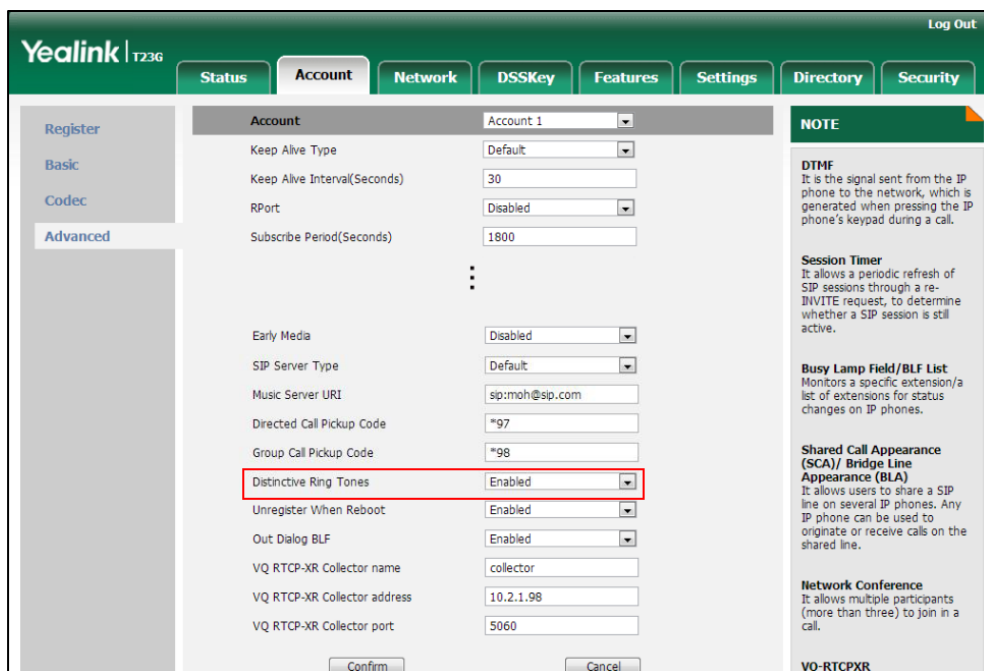

4. Click **Confirm** to accept the change.

To configure the internal ringer text and internal ringer file via web user interface:

1. Click on **Settings->Ring**.
2. Enter the keywords in the **Internal Ringer Text** fields.
3. Select the desired ring tones for each text from the pull-down lists of **Internal Ringer File**.

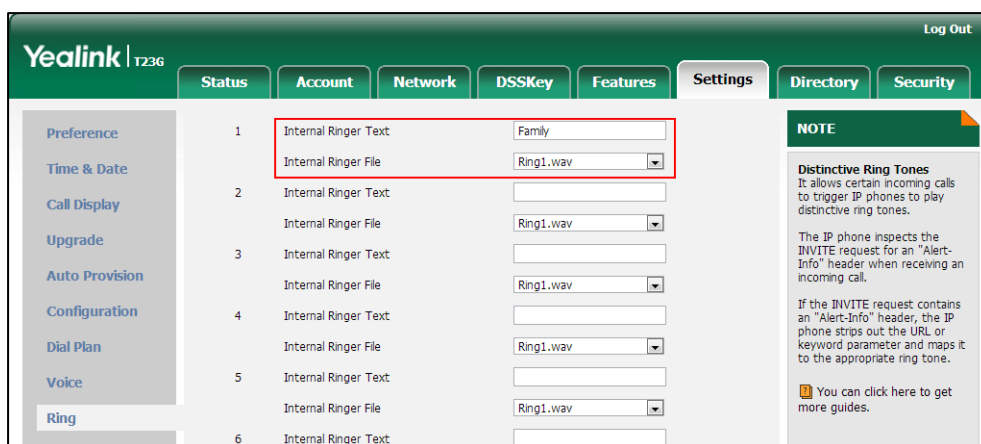

4. Click **Confirm** to accept the change.

Tones

When receiving a message, the IP phone will play a warning tone. You can customize tones or select specialized tone sets (vary from country to country) to indicate different conditions of the IP phone. The default tones used on IP phones are the US tone sets.

Available tone sets for IP phones:

- Australia
- Austria
- Brazil
- Belgium
- China
- Czech
- Denmark
- Finland
- France
- Germany
- Great Britain
- Greece
- Hungary
- Lithuania
- India

- Italy
- Japan
- Mexico
- New Zealand
- Netherlands
- Norway
- Portugal
- Spain
- Switzerland
- Sweden
- Russia
- United States
- Chile
- Czech ETSI

Configured tones can be heard on IP phones for the following conditions.

Condition	Description
Dial	When in the pre-dialing interface
Ring Back	Ring-back tone
Busy	When the callee is busy
Congestion	When the network is congested
Call Waiting	Call waiting tone
Dial Recall	When receiving a call back
Info	When receiving a special message
Stutter	When receiving a voice mail
Message	When receiving a text message
Auto Answer	When automatically answering a call

Procedure

Tones can be configured using the configuration files or locally.

Configuration File	<y0000000000xx>.cfg	Configure the tones for the IP phone. Parameters: voice.tone.country voice.tone.dial
---------------------------	---------------------	--

		voice.tone.ring voice.tone.busy voice.tone.congestion voice.tone.callwaiting voice.tone.dialrecall voice.tone.info voice.tone.stutter voice.tone.message voice.tone.autoanswer
Local	Web User Interface	Configure the tones for the IP phone. Navigate to: <a href="http://<phoneIPAddress>/servlet?p=settings-tones&q=load">http://<phoneIPAddress>/servlet?p=settings-tones&q=load

Details of Configuration Parameters:

Parameters	Permitted Values	Default
voice.tone.country	Refer to the following content	Custom
<p>Description: Configures the country tone for the IP phone.</p> <p>Permitted Values: Custom, Australia, Austria, Brazil, Belgium, Chile, China, Czech, Czech ETSI, Denmark, Finland, France, Germany, Great Britain, Greece, Hungary, Lithuania, India, Italy, Japan, Mexico, New Zealand, Netherlands, Norway, Portugal, Spain, Switzerland, Sweden, Russia, United States.</p> <p>Example: voice.tone.country = Custom</p> <p>Web User Interface: Settings->Tones->Select Country</p> <p>Phone User Interface: None</p>		
voice.tone.dial	String	Blank
<p>Description: Customizes the dial tone.</p>		

Parameters	Permitted Values	Default
<p>tonelist = element[,element] [,element]...</p> <p>Where</p> <p>element = [!]Freq1[+Freq2][+Freq3][+Freq4] /Duration</p> <p>Freq: the frequency of the tone (ranges from 200 to 4000Hz). If it is set to 0Hz, it means the tone is not played.</p> <p>For SIPT23P/T23G/T21(P) E2/T19(P) E2:</p> <p>A tone is comprised of at most two different frequencies.</p> <p>For SIPT48G/T46G/T42G/T41P/T29G/T27P:</p> <p>A tone is comprised of at most four different frequencies.</p> <p>Duration: the duration (in milliseconds) of the dial tone, ranges from 0 to 30000ms.</p> <p>You can configure at most eight different tones for one condition, and separate them by commas. (e.g., 250/200,0/1000,200+300/500,600+700+800+1000/2000).</p> <p>If you want the IP phone to play tones once, add an exclamation mark “!” before tones (e.g., !250/200,0/1000,200+300/500,600+700+800+1000/2000).</p> <p>Note: It works only if the value of the parameter “voice.tone.country” is set to Custom.</p> <p>Web User Interface:</p> <p>Settings->Tones->Dial</p> <p>Phone User Interface:</p> <p>None</p>		
voice.tone.ring	String	Blank
<p>Description:</p> <p>Customizes the ringback tone.</p> <p>The value format is Freq/Duration. For more information on the value format, refer to the parameter “voice.tone.dial”.</p> <p>Note: It works only if the value of the parameter “voice.tone.country” is set to Custom.</p> <p>Web User Interface:</p> <p>Settings->Tones->Ring Back</p> <p>Phone User Interface:</p> <p>None</p>		
voice.tone.busy	String	Blank
<p>Description:</p>		

Parameters	Permitted Values	Default
<p>Customizes the tone when the callee is busy.</p> <p>The value format is Freq/Duration. For more information on the value format, refer to the parameter "voice.tone.dial".</p> <p>Note: It works only if the value of the parameter "voice.tone.country" is set to Custom.</p> <p>Web User Interface: Settings->Tones->Busy</p> <p>Phone User Interface: None</p>		
voice.tone.congestion	String	Blank
<p>Description:</p> <p>Customizes the tone when the network is congested.</p> <p>The value format is Freq/Duration. For more information on the value format, refer to the parameter "voice.tone.dial".</p> <p>Note: It works only if the value of the parameter "voice.tone.country" is set to Custom.</p> <p>Web User Interface: Settings->Tones->Congestion</p> <p>Phone User Interface: None</p>		
voice.tone.callwaiting	String	Blank
<p>Description:</p> <p>Customizes the call waiting tone.</p> <p>The value format is Freq/Duration. For more information on the value format, refer to the parameter "voice.tone.dial".</p> <p>Note: It works only if the value of the parameter "voice.tone.country" is set to Custom.</p> <p>Web User Interface: Settings->Tones->Call Waiting</p> <p>Phone User Interface: None</p>		
voice.tone.dialrecall	String	Blank

Parameters	Permitted Values	Default
<p>Description: Customizes the call back tone. The value format is Freq/Duration. For more information on the value format, refer to the parameter "voice.tone.dial".</p> <p>Note: It works only if the value of the parameter "voice.tone.country" is set to Custom.</p> <p>Web User Interface: Settings->Tones->Dial Recall</p> <p>Phone User Interface: None</p>		
voice.tone.info	String	Blank
<p>Description: Customizes the info tone. The phone will play the info tone with the special information, for example, the number you are calling is not in service. The value format is Freq/Duration. For more information on the value format, refer to the parameter "voice.tone.dial".</p> <p>Note: It works only if the value of the parameter "voice.tone.country" is set to Custom.</p> <p>Web User Interface: Settings->Tones->Info</p> <p>Phone User Interface: None</p>		
voice.tone.stutter	String	Blank
<p>Description: Customizes the tone when the IP phone receives a voice mail. The value format is Freq/Duration. For more information on the value format, refer to the parameter "voice.tone.dial".</p> <p>Note: It works only if the value of the parameter "voice.tone.country" is set to Custom.</p> <p>Web User Interface: Settings->Tones->Stutter</p> <p>Phone User Interface: None</p>		

Parameters	Permitted Values	Default
voice.tone.message	String	Blank
<p>Description: Customizes the tone when the IP phone receives a text message. The value format is Freq/Duration. For more information on the value format, refer to the parameter "voice.tone.dial".</p> <p>Note: It works only if the value of the parameter "voice.tone.country" is set to Custom.</p> <p>Web User Interface: Settings->Tones->Message</p> <p>Phone User Interface: None</p>		
voice.tone.autoanswer	String	Blank
<p>Description: Customizes the warning tone for auto answer. The value format is Freq/Duration. For more information on the value format, refer to the parameter "voice.tone.dial".</p> <p>Note: It works only if the value of the parameter "voice.tone.country" is set to Custom.</p> <p>Web User Interface: Settings->Tones->Auto Answer</p> <p>Phone User Interface: None</p>		

To configure tones via web user interface:

1. Click on **Settings->Tones**.
2. Select the desired value from the pull-down list of **Select Country**.

If you select **Custom**, you can customize a tone for each condition of the IP phone.

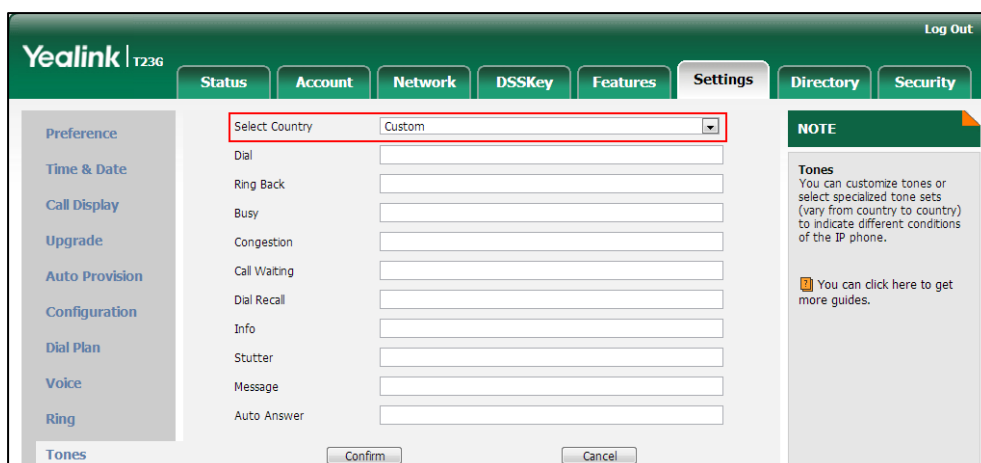

3. Click **Confirm** to accept the change.

Voice Mail Tone

Voice mail tone feature allows the IP phone to play a warning tone when receiving a new voice mail.

Procedure

Voice mail tone can be configured using the configuration files or locally.

Configuration File	<y0000000000xx>.cfg	Configure whether to play a warning tone when the IP phone receives a new voice mail. Parameters: features.voice_mail_tone_enable
Local	Web User Interface	Configure whether to play a warning tone when the IP phone receives a new voice mail. Navigate to: http://<phoneIPAddress>/servlet?p=features-general&q=load

Details of the Configuration Parameter:

Parameter	Permitted Values	Default
features.voice_mail_tone_enable	0 or 1	1

Parameter	Permitted Values	Default
<p>Description: Enables or disables the IP phone to play a warning tone when it receives a new voice mail.</p> <p>0-Disabled 1-Enabled</p> <p>Web User Interface: Features->General Information->Voice Mail Tone</p> <p>Phone User Interface: None</p>		

To configure voice mail tone via web user interface:

1. Click on **Features->General Information**.
2. Select the desired value from the pull-down list of **Voice Mail Tone**.

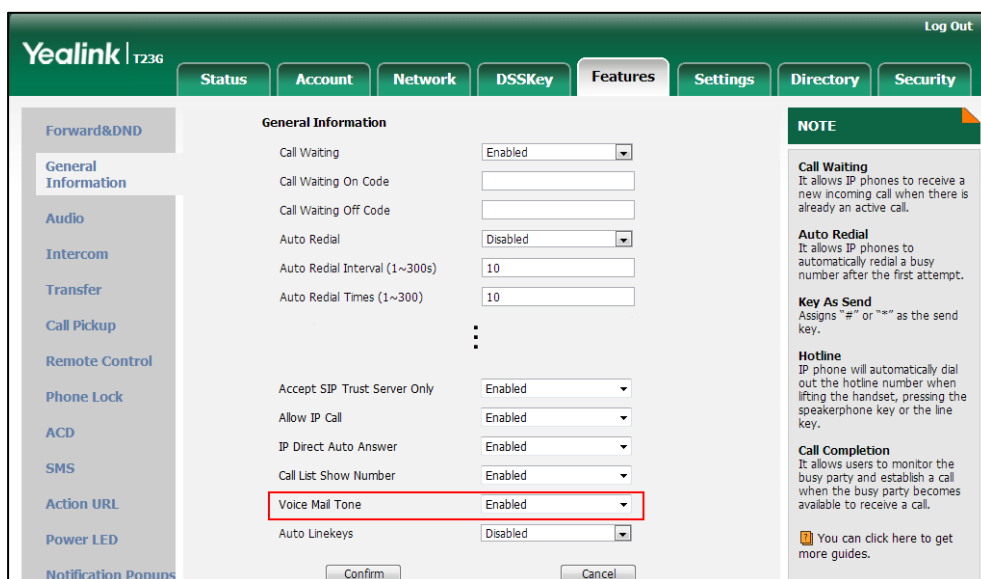

3. Click **Confirm** to accept the change.

Headset Prior

Headset prior allows users to use headset preferentially if a headset is physically connected to the IP phone. This feature is especially useful for permanent or full-time headset users.

Procedure

Headset prior can be configured using the configuration files or locally.

Configuration File	<y0000000000xx>.cfg	Configure headset prior. Parameter: features.headset_prior
Local	Web User Interface	Configure headset prior. Navigate to: http://<phoneIPAddress>/ servlet?p=features-general&q=load

Details of the Configuration Parameter:

Parameter	Permitted Values	Default
features.headset_prior	0 or 1	0
<p>Description: Enables or disables headset prior feature. You need to press the HEADSET key to activate the headset mode in advance.</p> <p>0-Disabled 1-Enabled</p> <p>If it is set to 1 (Enabled), the headset mode will not be deactivated until the user presses the HEADSET key again.</p> <p>If it is set to 0 (Disabled), the headset mode can be deactivated by pressing the speakerphone key or the HEADSET key except the HANDSET key.</p> <p>Web User Interface: Features->General Information->Headset Prior</p> <p>Phone User Interface: None</p>		

To configure headset prior via web user interface:

1. Click on **Features->General Information**.

2. Select the desired value from the pull-down list of **Headset Prior**.

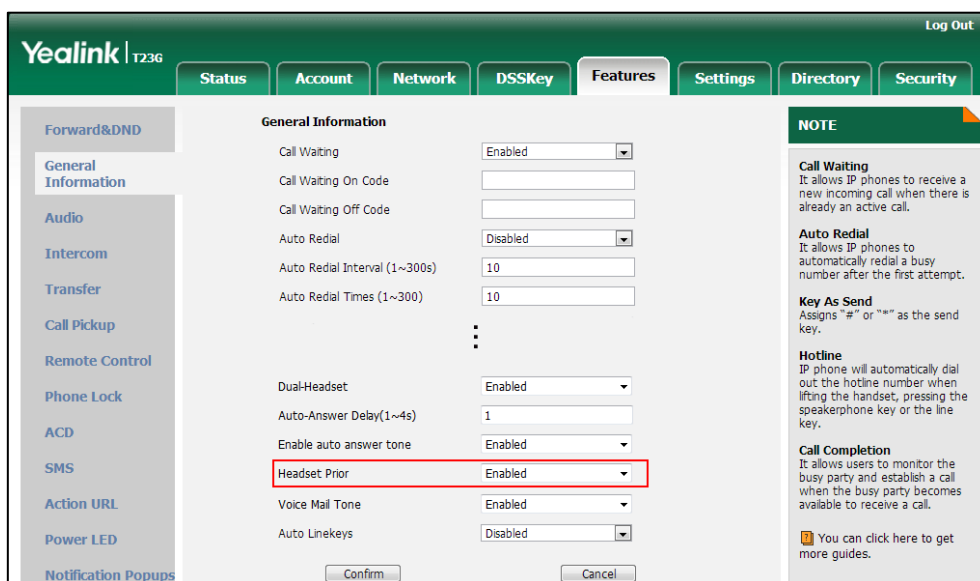

3. Click **Confirm** to accept the change.

Dual Headset

Dual headset allows users to use two headsets on one IP phone. To use this feature, users need to physically connect two headsets to the headset and handset jacks respectively. Once the IP phone connects to a call, the user with the headset connected to the headset jack has full-duplex capabilities, while the user with the headset connected to the handset jack is only able to listen.

Procedure

Dual headset can be configured using the configuration files or locally.

Configuration File	<y0000000000xx>.cfg	Configure dual headset. Parameter: features.headset_training
Local	Web User Interface	Configure dual headset. Navigate to: http://<phoneIPAddress>/se rvlet?p=features-general&q =load

Details of the Configuration Parameter:

Parameter	Permitted Values	Default
features.headset_training	0 or 1	0

Description:
 Enables or disables dual headset feature.
 0-Disabled
 1-Enabled
 If it is set to 1 (Enabled), users can use two headsets on one phone. When the IP phone joins in a call, the users with the headset connected to the headset jack have a full-duplex conversation, while the users with the headset connected to the handset jack are only allowed to listen to.

Web User Interface:
 Features->General Information->Dual-Headset

Phone User Interface:
 None

To configure dual headset via web user interface:

1. Click on **Features->General Information**.
2. Select the desired value from the pull-down list of **Dual-Headset**.

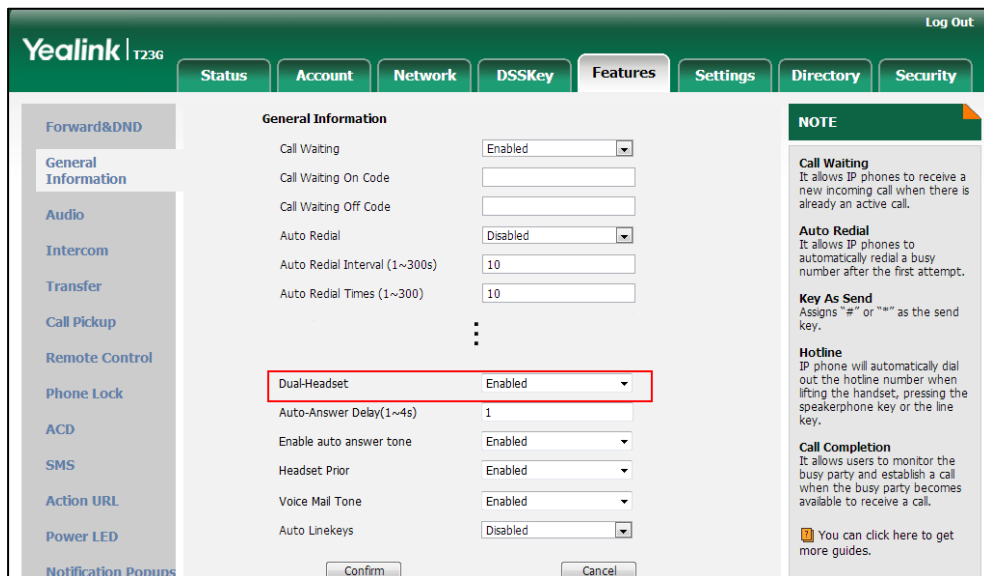

3. Click **Confirm** to accept the change.

Sending Volume

Sending volume allows user to adjust the sending volume of currently engaged audio devices (handset, speakerphone or headset) when the phone is in use.

Procedure

Sending volume can be configured using the configuration files.

Configuration File	<y0000000000xx>.cfg	<p>Configure the sending volume of the speaker.</p> <p>Parameter: voice.handfree_send</p> <p>Configure the sending volume of the handset.</p> <p>Parameter: voice.handset_send</p> <p>Configure the sending volume of the headset.</p> <p>Parameter: voice.headset_send</p>
---------------------------	---------------------	--

Details of the Configuration Parameter:

Parameter	Permitted Values	Default
voice.handfree_send	Integer from -50 to 50	0
<p>Description: Configures the sending volume of the speaker.</p> <p>Note: We recommend that you modify this parameter cautiously. An unreasonable value may render the voice quality bad. If you change this parameter, the IP phone will reboot to make the change take effect.</p> <p>Web User Interface: None</p> <p>Phone User Interface: None</p>		
voice.handset_send	Integer from -50 to 50	0
<p>Description: Configures the sending volume of the handset.</p>		

Parameter	Permitted Values	Default
<p>Note: We recommend that you modify this parameter cautiously. An unreasonable value may render the voice quality bad. If you change this parameter, the IP phone will reboot to make the change take effect.</p> <p>Web User Interface: None</p> <p>Phone User Interface: None</p>		
<code>voice.headset_send</code>	Integer from -50 to 50	0
<p>Description: Configures the sending volume of the headset.</p> <p>Note: We recommend that you modify this parameter cautiously. An unreasonable value may render the voice quality bad. If you change this parameter, the IP phone will reboot to make the change take effect.</p> <p>Web User Interface: None</p> <p>Phone User Interface: None</p>		

Audio Codecs

CODEC is an abbreviation of COmpress-DECompress, capable of coding or decoding a digital data stream or signal by implementing an algorithm. The object of the algorithm is to represent the high-fidelity audio signal with minimum number of bits while retaining the quality. This can effectively reduce the frame size and the bandwidth required for audio transmission.

The audio codec that the phone uses to establish a call should be supported by the SIP server. When placing a call, the IP phone will offer the enabled audio codec list to the server and then use the audio codec negotiated with the called party according to the priority.

The following table lists the audio codecs supported by each phone model:

Phone Model	Supported Audio Codecs	Default Audio Codecs
SIP-T48G/T46G/T42 G/T41P/T29G	G722, PCMA, PCMU, G729, G726-16, G726-24, G726-32, G726-40, iLBC, G723_53, G723_63	G722, PCMA, PCMU, G729

SIP-T27P/T23P/T23G/ T21(P) E2	G722, PCMA, PCMU, G729, G726-16, G726-24, G726-32, G726-40, iLBC	G722, PCMA, PCMU, G729
----------------------------------	--	---------------------------

The following table summarizes the supported audio codecs on IP phones:

Codec	Algorithm	Reference	Bit Rate	Sample Rate	Packetization Time
G722	G.722	RFC 3551	64 Kbps	16 Ksps	20ms
PCMA	G.711 a-law	RFC 3551	64 Kbps	8 Ksps	20ms
PCMU	G.711 u-law	RFC 3551	64 Kbps	8 Ksps	20ms
G729	G.729	RFC 3551	8 Kbps	8 Ksps	20ms
G726-16	G.726	RFC 3551	16 Kbps	8 Ksps	20ms
G726-24	G.726	RFC 3551	24 Kbps	8 Ksps	20ms
G726-32	G.726	RFC 3551	32 Kbps	8 Ksps	20ms
G726-40	G.726	RFC 3551	40 Kbps	8 Ksps	20ms
G723_53/ G723_63	G.723.1	RFC 3951	5.3kbps 6.3kbps	8 Ksps	30ms
iLBC	iLBC	RFC 3952	13.33 Kbps 15.2 Kbps	8 Ksps	20ms 30ms

Packetization Time

Ptime (Packetization Time) is a measurement of the duration (in milliseconds) of the audio data in each RTP packet sent to the destination, and defines how much network bandwidth is used for the RTP stream transfer. Before establishing a conversation, codec and ptime are negotiated through SIP signaling. The valid values of ptime range from 10 to 60, in increments of 10 milliseconds. The default ptime is 20ms. You can also disable the ptime negotiation.

Codecs and priorities of these codecs are configurable on a per-line basis. The attribute "rtpmap" is used to define a mapping from RTP payload codes to a codec, clock rate and other encoding parameters.

The corresponding attributes of the codec are listed as follows:

Codec	Configuration Methods	Priority	RTPmap
G722	Configuration Files Web User Interface	1	9
PCMU	Configuration Files Web User Interface	2	0

Codec	Configuration Methods	Priority	RTPmap
PCMA	Configuration Files Web User Interface	3	8
G729	Configuration Files Web User Interface	4	18
G723_53	Configuration Files Web User Interface	0	4
G723_63	Configuration Files Web User Interface	0	4
G726-16	Configuration Files Web User Interface	0	103
G726-24	Configuration Files Web User Interface	0	104
G726-32	Configuration Files Web User Interface	0	102
G726-40	Configuration Files Web User Interface	0	105
iLBC	Configuration Files Web User Interface	0	106

Procedure

Configuration changes can be performed using the configuration files or locally.

Configuration File	<MAC>.cfg	<p>Configure the codecs to use on a per-line basis.</p> <p>Parameters:</p> <p>account.X.codec.Y.enable account.X.codec.Y.payload_type</p> <p>Configure the priority and rtpmap for the enabled codec.</p> <p>Parameters:</p> <p>account.X.codec.Y.priority account.X.codec.Y.rtpmap</p> <p>Configure the ptime.</p> <p>Parameter:</p> <p>account.X.ptime</p>
--------------------	-----------	---

<p>Local</p>	<p>Web User Interface</p>	<p>Configure the codecs to use on a per-line basis.</p> <p>Configure the priority for the enabled codec.</p> <p>Navigate to: <a href="http://<phoneIPAddress>/servlet?p=account-codec&q=load&acc=0">http://<phoneIPAddress>/servlet?p=account-codec&q=load&acc=0</p> <p>Configure the ptime.</p> <p>Navigate to: <a href="http://<phoneIPAddress>/servlet?p=account-adv&q=load&acc=0">http://<phoneIPAddress>/servlet?p=account-adv&q=load&acc=0</p>
---------------------	---------------------------	--

Details of Configuration Parameters:

Parameters	Permitted Values	Default
<p>account.X.codec.Y.enable (X ranges from 1 to 16, Y ranges from 1 to 11)</p>	<p>0 or 1</p>	<p>Refer to the following content</p>
<p>Description: Enables or disables the specified codec for account X.</p> <p>0-Disabled 1-Enabled</p> <p>X ranges from 1 to 16 (for SIP-T48G/T46G/T29G) X ranges from 1 to 12 (for SIP-T42G) X ranges from 1 to 6 (for SIP-T41P/T27P) X ranges from 1 to 3 (for SIP-T23P/G) X ranges from 1 to 2 (for SIP-T21(P) E2) X is equal to 1 (for SIP-T19(P) E2)</p> <p>Default: For SIP-T48G/T46G/T42G/T41P/T29G: When Y=1, the default value is 1; When Y=2, the default value is 1; When Y=3, the default value is 0; When Y=4, the default value is 0; When Y=5, the default value is 1; When Y=6, the default value is 1; When Y=7, the default value is 0; When Y=8, the default value is 0;</p>		

Parameters	Permitted Values	Default
<p>When Y=9, the default value is 0; When Y=10, the default value is 0; When Y=11, the default value is 0; For SIP-T27P/T23P/T23G/T21(P) E2/T19(P) E2: When Y=1, the default value is 1; When Y=2, the default value is 1; When Y=3, the default value is 1; When Y=4, the default value is 1; When Y=5, the default value is 0; When Y=6, the default value is 0; When Y=7, the default value is 0; When Y=8, the default value is 0; When Y=9, the default value is 0;</p> <p>Example: account.1.codec.1.enable = 1</p> <p>It means that the codec PCMU is enabled on the account 1.</p> <p>Web User Interface: Account->Codec</p> <p>Phone User Interface: None</p>		
<p>account.X.codec.Y.payload_type (X ranges from 1 to 16, Y ranges from 1 to 11)</p>	<p>Refer to the following content</p>	<p>Refer to the following content</p>
<p>Description: Configures the codec for account X. X ranges from 1 to 16 (for SIP-T48G/T46G/T29G) X ranges from 1 to 12 (for SIP-T42G) X ranges from 1 to 6 (for SIP-T41P/T27P) X ranges from 1 to 3 (for SIP-T23P/G) X ranges from 1 to 2 (for SIP-T21(P) E2) X is equal to 1 (for SIP-T19(P) E2)</p> <p>Permitted Values: G722, PCMU, PCMA, G729, G726-16, G726-24, G726-32, G726-40, iLBC, G723_53, G723_63</p>		

Parameters	Permitted Values	Default
<p>For SIP-T48G/T46G/T42G/T41P/T29G: When Y=1, the default value is PCMU; When Y=2, the default value is PCMA; When Y=3, the default value is G723_53; When Y=4, the default value is G723_63; When Y=5, the default value is G729; When Y=6, the default value is G722; When Y=7, the default value is iLBC; When Y=8, the default value is G726-16; When Y=9, the default value is G726-24; When Y=10, the default value is G726-32; When Y=11, the default value is G726-40;</p> <p>For SIP-T27P/T23P/T23G/T21(P) E2/T19(P) E2: When Y=1, the default value is PCMU; When Y=2, the default value is PCMA; When Y=3, the default value is G729; When Y=4, the default value is G722; When Y=5, the default value is iLBC; When Y=6, the default value is G726-16; When Y=7, the default value is G726-24; When Y=8, the default value is G726-32; When Y=9, the default value is G726-40;</p> <p>Example: account.1.codec.1.payload_type = PCMU</p> <p>Web User Interface: Account->Codec</p> <p>Phone User Interface: None</p>		
<p>account.X.codec.Y.priority (X ranges from 1 to 16, Y ranges from 1 to 11)</p>	<p>Integer from 0 to 11</p>	<p>Refer to the following content</p>
<p>Description: Configures the priority of the enabled codec for account X. X ranges from 1 to 16 (for SIP-T48G/T46G/T29G) X ranges from 1 to 12 (for SIP-T42G)</p>		

Parameters	Permitted Values	Default
<p>X ranges from 1 to 6 (for SIP-T41P/T27P) X ranges from 1 to 3 (for SIP-T23P/G) X ranges from 1 to 2 (for SIP-T21(P) E2) X is equal to 1 (for SIP-T19(P) E2)</p> <p>For SIP-T48G/T46G/T42G/T41P/T29G:</p> <p>When Y=1, the default value is 2; When Y=2, the default value is 3; When Y=3, the default value is 0; When Y=4, the default value is 0; When Y=5, the default value is 4; When Y=6, the default value is 1; When Y=7, the default value is 0; When Y=8, the default value is 0; When Y=9, the default value is 0; When Y=10, the default value is 0; When Y=11, the default value is 0;</p> <p>For SIP-T27P/T23P/T23G/T21(P) E2/T19(P) E2:</p> <p>When Y=1, the default value is 2; When Y=2, the default value is 3; When Y=3, the default value is 4; When Y=4, the default value is 1; When Y=5, the default value is 0; When Y=6, the default value is 0; When Y=7, the default value is 0; When Y=8, the default value is 0; When Y=9, the default value is 0;</p> <p>Example: account.1.codec.1.priority = 2</p> <p>Web User Interface: Account->Codec</p> <p>Phone User Interface: None</p>		
<p>account.X.codec.Y.rtpmap (X ranges from 1 to 16, Y ranges from 1 to 11)</p>	<p>Integer from 0 to 127</p>	<p>Refer to the following content</p>



Parameters	Permitted Values	Default
<p>Description: Configures the rtpmap of the audio codec for account X. X ranges from 1 to 16 (for SIP-T48G/T46G/T29G) X ranges from 1 to 12 (for SIP-T42G) X ranges from 1 to 6 (for SIP-T41P/T27P) X ranges from 1 to 3 (for SIP-T23P/G) X ranges from 1 to 2 (for SIP-T21(P) E2) X is equal to 1 (for SIP-T19(P) E2)</p> <p>For SIP-T48G/T46G/T42G/T41P/T29G: When Y=1, the default value is 0; When Y=2, the default value is 8; When Y=3, the default value is 4; When Y=4, the default value is 4; When Y=5, the default value is 18; When Y=6, the default value is 9; When Y=7, the default value is 106; When Y=8, the default value is 103; When Y=9, the default value is 104; When Y=10, the default value is 102; When Y=11, the default value is 105;</p> <p>For SIP-T27P/T23P/T23G/T21(P) E2/T19(P) E2: When Y=1, the default value is 0; When Y=2, the default value is 8; When Y=3, the default value is 18; When Y=4, the default value is 9; When Y=5, the default value is 106; When Y=6, the default value is 103; When Y=7, the default value is 104; When Y=8, the default value is 102; When Y=9, the default value is 105;</p> <p>Example: account.1.codec.1.rtpmap = 0</p> <p>Web User Interface: None</p>		

Parameters	Permitted Values	Default
Phone User Interface: None		
account.X.ptime	0, 10, 20, 30, 40, 50 or 60	20
<p>Description: Configures the ptime (in milliseconds) for the codec for account X.</p> <p>0-Disabled</p> <p>10-10</p> <p>20-20</p> <p>30-30</p> <p>40-40</p> <p>50-50</p> <p>60-60</p> <p>X ranges from 1 to 16 (for SIP-T48G/T46G/T29G)</p> <p>X ranges from 1 to 12 (for SIP-T42G)</p> <p>X ranges from 1 to 6 (for SIP-T41P/T27P)</p> <p>X ranges from 1 to 3 (for SIP-T23P/G)</p> <p>X ranges from 1 to 2 (for SIP-T21(P) E2)</p> <p>X is equal to 1 (for SIP-T19(P) E2)</p> <p>Example: account.1.ptime = 20</p> <p>Web User Interface: Account->Advanced->PTime(ms)</p> <p>Phone User Interface: None</p>		

To configure the codecs to use and adjust the priority of the enabled codecs on a per-line basis via web user interface:

1. Click on **Account**.
2. Select the desired account from the pull-down list of **Account**.
3. Click on **Codec**.
4. Select the desired codec from the **Disable Codecs** column and then click  .
The selected codec appears in the **Enable Codecs** column.
5. Repeat the step 4 to add more codecs to the **Enable Codecs** column.
6. To remove the codec from the **Enable Codecs** column, select the desired codec

and then click  .

- To adjust the priority of codecs, select the desired codec and then click  or  .

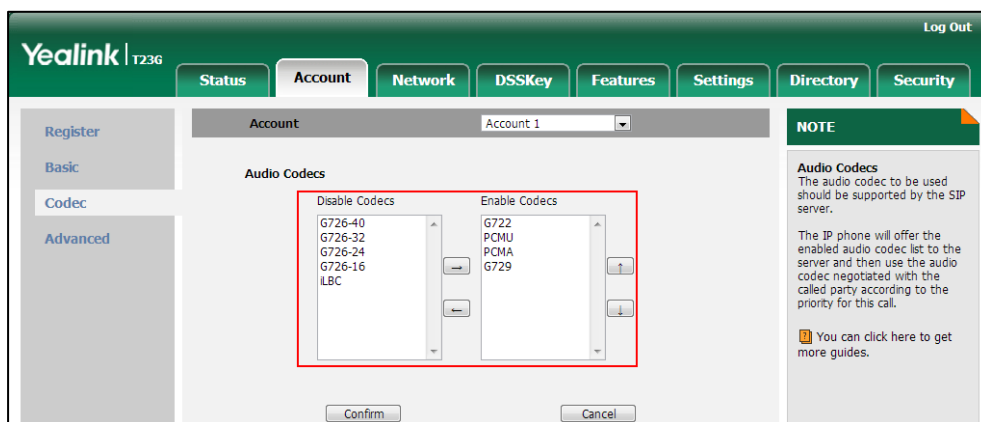

- Click **Confirm** to accept the change.

To configure the ptime for the account via web user interface:

- Click on **Account->Advanced**.
- Select the desired account from the pull-down list of **Account**.
- Select the desired value from the pull-down list of **PTime(ms)**.

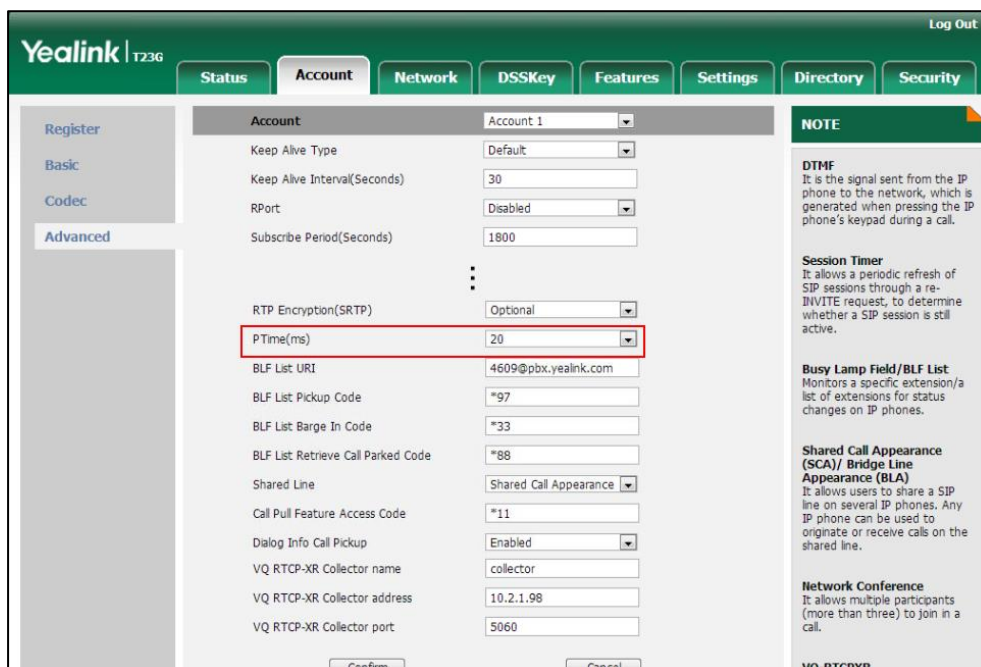

- Click **Confirm** to accept the change.

Acoustic Clarity Technology

Acoustic Echo Cancellation

Acoustic Echo Cancellation (AEC) is used to reduce acoustic echo from a voice call to provide natural full-duplex communication patterns. It also increases the capacity achieved through silence suppression by preventing echo from traveling across a network. IP phones employ advanced AEC for hands-free operation. AEC is not normally required for calls via the handset. In certain situation, where echo is experienced by the remote party, AEC may be used to reduce/avoid echo when the user uses the handset.

Note Utilizing acoustic echo cancellation will introduce a small delay increase into audio path which might cause a lower voice quality.

Procedure

AEC can be configured using the configuration files or locally.

Configuration File	<y0000000000xx>.cfg	Configure AEC. Parameter: voice.echo_cancellation
Local	Web User Interface	Configure AEC. Navigate to: <a href="http://<phoneIPAddress>/servlet?p=settings-voice&q=load">http://<phoneIPAddress>/servlet?p=settings-voice&q=load

Details of the Configuration Parameter:

Parameter	Permitted Values	Default
voice.echo_cancellation	0 or 1	1
Description: Enables or disables the AEC (Acoustic Echo Canceller) feature on the IP phone. 0-Disabled 1-Enabled Web User Interface: Settings->Voice->Echo Cancellation->ECHO		

Parameter	Permitted Values	Default
Phone User Interface:		
	None	

To configure AEC via web user interface:

1. Click on **Settings->Voice**.
2. Select the desired value from the pull-down list of **ECHO**.

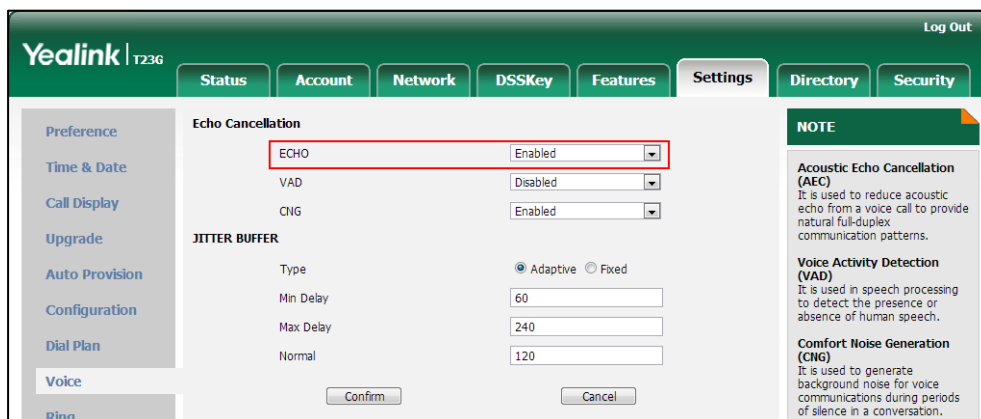

3. Click **Confirm** to accept the change.

Background Noise Suppression

Background noise suppression (BNS) is designed primarily for hands-free operation and reduces background noise to enhance communication in noisy environments.

Automatic Gain Control

Automatic Gain Control (AGC) is applicable to hands-free operation and is used to keep audio output at nearly a constant level by adjusting the gain of signals in certain circumstances. This increases the effective user-phone radius and helps with the intelligibility of talkers.

Voice Activity Detection

Voice Activity Detection (VAD) is used in speech processing to detect the presence or absence of human speech. When detecting period of "silence", VAD replaces that silence efficiently with special packets that indicate silence is occurring. It can facilitate speech processing, and deactivate some processes during non-speech section of an audio session. VAD can avoid unnecessary coding or transmission of silence packets in VoIP applications, saving on computation and network bandwidth.

Procedure

VAD can be configured using the configuration files or locally.

Configuration File	<y0000000000xx>.cfg	Configure VAD. Parameter: voice.vad
Local	Web User Interface	Configure VAD. Navigate to: http://<phoneIPAddress>/servlet?p=settings-voice&q=load

Details of the Configuration Parameter:

Parameter	Permitted Values	Default
voice.vad	0 or 1	0
<p>Description: Enables or disables the VAD (Voice Activity Detection) feature on the IP phone.</p> <p>0-Disabled 1-Enabled</p> <p>Web User Interface: Settings->Voice->Echo Cancellation->VAD</p> <p>Phone User Interface: None</p>		

To configure VAD via web user interface:

1. Click on **Settings->Voice**.
2. Select the desired value from the pull-down list of **VAD**.

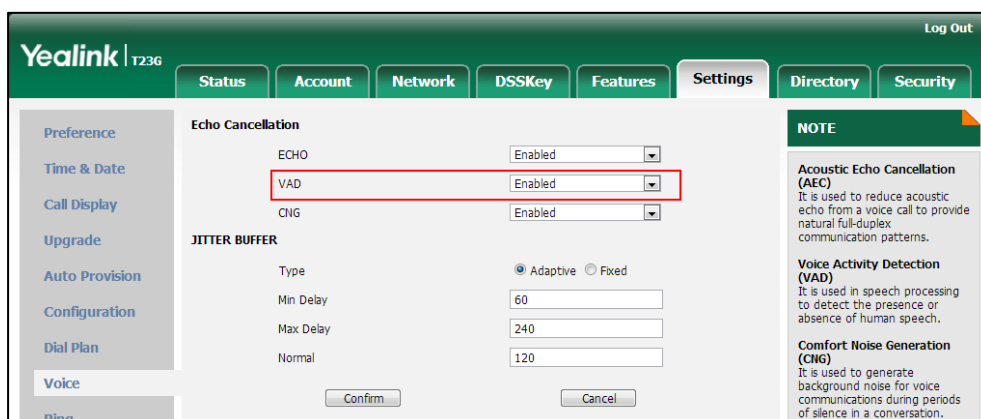

3. Click **Confirm** to accept the change.

Comfort Noise Generation

Comfort Noise Generation (CNG) is used to generate background noise for voice communications during periods of silence in a conversation. It is a part of the silence suppression or VAD handling for VoIP technology. CNG, in conjunction with VAD algorithms, quickly responds when periods of silence occur and inserts artificial noise until voice activity resumes. The insertion of artificial noise gives the illusion of a constant transmission stream, so that background sound is consistent throughout the call and the listener does not think the line has released. The purpose of VAD and CNG is to maintain an acceptable perceived QoS while simultaneously keeping transmission costs and bandwidth usage as low as possible.

Note

VAD is used to send CN packets when phone detect a "silence" period; CNG is used to generate comfortable noise when phone receives CN packets from the other side.

For example, A is talking with B.

A: VAD=1, CNG=1

B: VAD=0, CNG=1

If A mutes the call, since VAD=1, A will send CN packets to B. When receiving CN packets, B will generate comfortable noise.

If B mutes the call, since VAD=0, B will not send CN packets to A. So even if CNG=1 (B), A will not hear comfortable noise.

Procedure

CNG can be configured using the configuration files or locally.

Configuration File	<y0000000000xx>.cfg	Configure CNG. Parameter: voice.cng
Local	Web User Interface	Configure CNG. Navigate to: <a href="http://<phoneIPAddress>/servlet?p=settings-voice&q=load">http://<phoneIPAddress>/servlet?p=settings-voice&q=load

Details of the Configuration Parameter:

Parameter	Permitted Values	Default
voice.cng	0 or 1	1
<p>Description: Enables or disables the CNG (Comfortable Noise Generation) feature on the IP phone.</p> <p>0-Disabled 1-Enabled</p> <p>Web User Interface: Settings->Voice->Echo Cancellation->CNG</p> <p>Phone User Interface: None</p>		

To configure CNG via web user interface:

1. Click on **Settings->Voice**.
2. Select the desired value from the pull-down list of **CNG**.

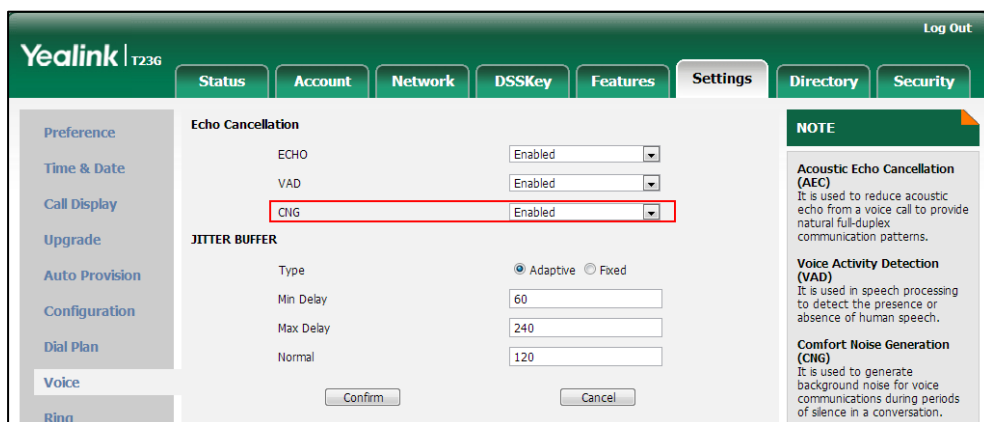

3. Click **Confirm** to accept the change.

Jitter Buffer

Jitter buffer is a shared data area where voice packets can be collected, stored, and sent to the voice processor in even intervals. Jitter is a term indicating variations in packet arrival time, which can occur because of network congestion, timing drift or route changes. The jitter buffer, located at the receiving end of the voice connection, intentionally delays the arriving packets so that the end user experiences a clear connection with very little sound distortion. IP phones support two types of jitter buffers: fixed and adaptive. A fixed jitter buffer adds the fixed delay to voice packets. You can

configure the delay time for the static jitter buffer on IP phones. An adaptive jitter buffer is capable of adapting the changes in the network's delay. The range of the delay time for the dynamic jitter buffer added to packets can be also configured on IP phones.

Procedure

Jitter buffer can be configured using the configuration files or locally.

Configuration File	<y0000000000xx>.cfg	Configure the mode of jitter buffer and the delay time for jitter buffer. Parameters: voice.jib.adaptive voice.jib.min voice.jib.max voice.jib.normal
Local	Web User Interface	Configure the mode of jitter buffer and the delay time for jitter buffer. Navigate to: http://<phoneIPAddress>/servlet?p=settings-voice&q=load

Details of Configuration Parameters:

Parameters	Permitted Values	Default
voice.jib.adaptive	0 or 1	1
Description: Configures the type of jitter buffer. 0-Fixed 1-Adaptive Web User Interface: Settings->Voice->JITTER BUFFER->Type Phone User Interface: None		
voice.jib.min	Integer from 0 to 400	60
Description: Configures the minimum delay time (in milliseconds) of jitter buffer. Note: It works only if the value of the parameter "voice.jib.adaptive" is set to 1		

Parameters	Permitted Values	Default
(Adaptive). Web User Interface: Settings->Voice->JITTER BUFFER->Min Delay Phone User Interface: None		
voice.jib.max	Integer from 0 to 400	240
Description: Configures the maximum delay time (in milliseconds) of jitter buffer. Note: It works only if the value of the parameter "voice.jib.adaptive" is set to 1 (Adaptive). Web User Interface: Settings->Voice->JITTER BUFFER->Max Delay Phone User Interface: None		
voice.jib.normal	Integer from 0 to 400	120
Description: Configures the normal delay time (in milliseconds) of jitter buffer. Note: It works only if the value of the parameter "voice.jib.adaptive" is set to 0 (Fixed). Web User Interface: Settings->Voice->JITTER BUFFER->Normal Phone User Interface: None		

To configure Jitter Buffer via web user interface:

1. Click on **Settings->Voice**.
2. Mark the desired radio box in the **Type** field.
3. Enter the minimum delay time for adaptive jitter buffer in the **Min Delay** field.
The valid value ranges from 0 to 300.
4. Enter the maximum delay time for adaptive jitter buffer in the **Max Delay** field.
The valid value ranges from 0 to 300.
5. Enter the fixed delay time for fixed jitter buffer in the **Normal** field.

The valid value ranges from 0 to 300.

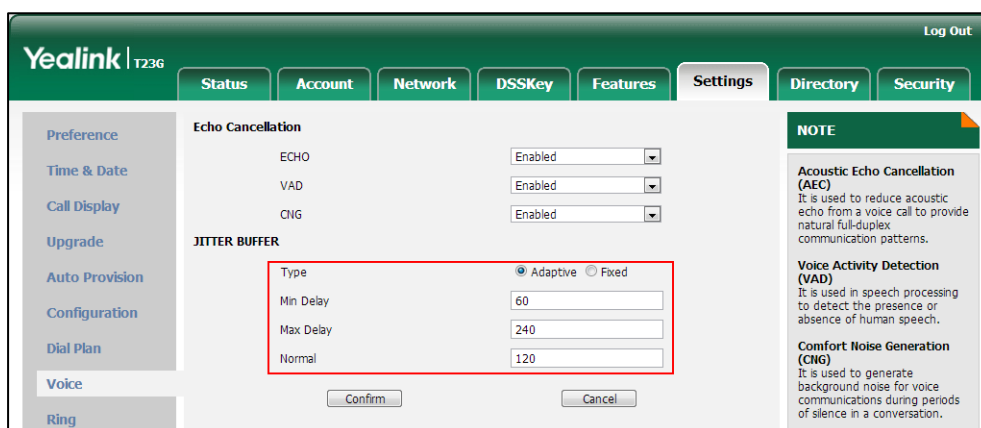

6. Click **Confirm** to accept the change.

Configuring Security Features

This chapter provides information for making configuration changes for the following security-related features:

- [User Password](#)
- [Administrator Password](#)
- [Auto-Logout Time](#)
- [Phone Lock](#)
- [Transport Layer Security](#)
- [Secure Real-Time Transport Protocol](#)
- [Encrypting Configuration Files](#)
- [802.1X Authentication](#)

User Password

Some menu options are protected by two privilege levels, user and administrator, each with its own password. When logging into the web user interface, you need to enter the user name and password to access various menu options.

A user or an administrator can change the user password. The default user password is "user". For security reasons, the user or administrator should change the default user password as soon as possible.

Procedure

User password can be changed using the configuration files or locally.

Configuration File	<y0000000000xx>.cfg	Change the user password of the IP phone. Parameter: security.user_password
Local	Web User Interface	Change the user password of the IP phone. Navigate to: http://<phoneIPAddress>/servlet?p=security&q=load

Details of the Configuration Parameter:

Parameter	Permitted Values	Default
security.user_password	String within 32 characters	user

Description:
 Configures the password of the user for phone's web user interface access.
 The IP phone uses "user" as the default user password.
 The valid value format is username:new password.

Example:
 security.user_password = user:123 means setting the password of user (current user name is "user") to password 123.

Note: IP phones support ASCII characters 32-126(0x20-0x7E) in passwords. You can set the password to be empty via web user interface only.

Web User Interface:
 Security->Password

Phone User Interface:
 None

To change the user password via web user interface:

1. Click on **Security->Password**.
2. Select **user** from the pull-down list of **User Type**.
3. Enter new password in the **New Password** and **Confirm Password** fields.
 Valid characters are ASCII characters 32-126(0x20-0x7E) except 58(3A).

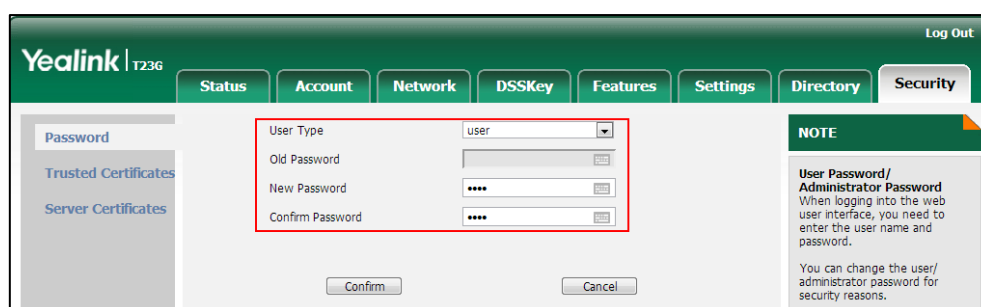

4. Click **Confirm** to accept the change.

Note If logging into the web user interface of the phone with the user credential, you need to enter the old user password in the **Old Password** field.

Administrator Password

Advanced menu options are strictly used by administrators. Users can configure them only if they have administrator privileges. The administrator password can only be changed by an administrator. The default administrator password is “admin”. For security reasons, the administrator should change the default administrator password as soon as possible.

Procedure

Administrator password can be changed using the configuration files or locally.

Configuration File	<y0000000000xx>.cfg	Change the administrator password. Parameter: security.user_password
Local	Web User Interface	Change the administrator password. Navigate to: http://<phoneIPAddress>/servlet?p=security&q=load
	Phone User Interface	Change the administrator password.

Details of the Configuration Parameter:

Parameter	Permitted Values	Default
security.user_password	String within 32 characters	admin
<p>Description: Configures the password of the administrator for phone’s web user interface access. The IP phone uses “admin” as the default administrator password.</p> <p>Example: security.user_password = admin:123 means setting the password of administrator (current user name is “admin”) to password 123.</p> <p>Note: IP phones support ASCII characters 32-126(0x20-0x7E) in passwords. You can set the password to be empty via web user interface only.</p> <p>Web User Interface: Security->Password</p> <p>Phone User Interface:</p>		

Parameter	Permitted Values	Default
Menu->Settings->Advanced Settings->Set Password		

To change the administrator password via web user interface:

1. Click on **Security->Password**.
2. Select **admin** from the pull-down list of **User Type**.
3. Enter the current administrator password in the **Old Password** field.
4. Enter new password in the **New Password** and **Confirm Password** fields.
Valid characters are ASCII characters 32-126(0x20-0x7E) except 58(3A).

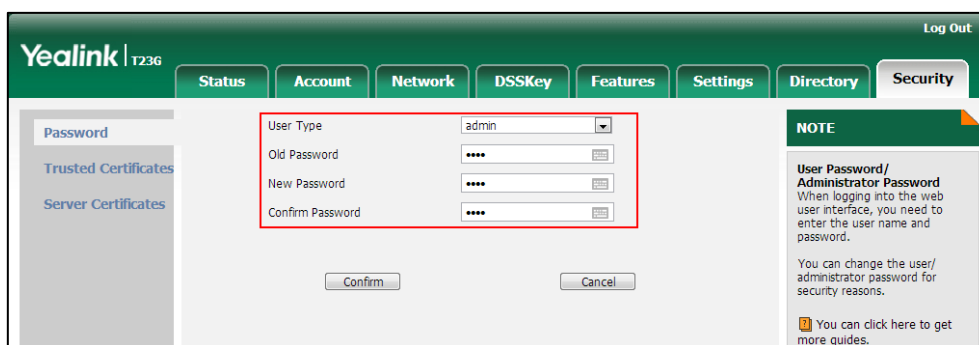

5. Click **Confirm** to accept the change.

To change the administrator password via phone user interface:

1. Press **Menu->Settings->Advanced Settings** (default password: admin) ->**Set Password**.
2. Enter the current administrator password in the **Old PWD** field.
3. Enter new password in the **New PWD** field and **Confirm PWD** field.
Valid characters are ASCII characters 32-126(0x20-0x7E).
4. Press the **Save** soft key to accept the change.

Auto-Logout Time

Auto-logout time defines a specific period of time during which the IP phones will automatically log out if you have not performed any actions via web user interface. Once logging out, you must re-enter username and password for web access authentication.

Procedure

Auto-logout time can be configured using the configuration files or locally.

Configuration File	<y0000000000xx>.cfg	Configure auto-logout time.
---------------------------	---------------------	-----------------------------

		Parameter: features.relog_offtime
Local	Web User Interface	Configure auto-logout time. Navigate to: http://<phoneIPAddress>/servlet ?p=features-general&q=load

Details of the Configuration Parameter:

Parameter	Permitted Values	Default
features.relog_offtime	Integer from 1 to 1000	5
<p>Description: Configures the timeout interval (in minutes) for web access authentication.</p> <p>Example: features.relog_offtime = 5</p> <p>If you log into the web user interface and leave it for 5 minutes, it will automatically log out.</p> <p>Note: If you change this parameter, the IP phone will reboot to make the change take effect.</p> <p>Web User Interface: Features->General Information->Auto-Logout Time(1~1000min)</p> <p>Phone User Interface: None</p>		

To configure the auto-logout time via web user interface:

1. Click on **Features->General Information**.

2. Enter the desired auto-logout time in **Auto-Logout Time(1~1000min)** field.

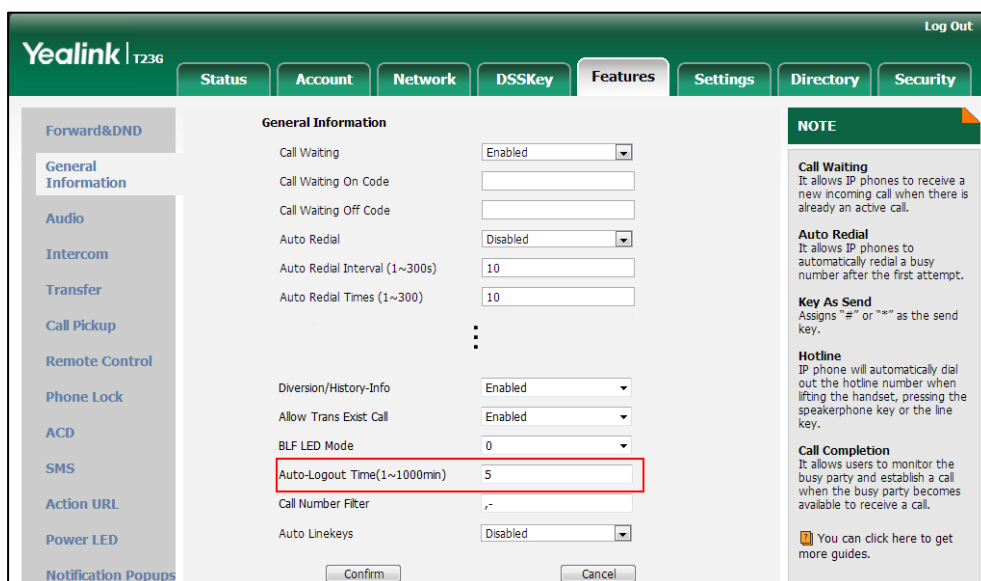

3. Click **Confirm** to accept the change.

Phone Lock

Phone lock is used to lock the IP phone to prevent it from unauthorized use. Once the IP phone is locked, a user must enter the password to unlock it. IP phones offer three types of phone lock: Menu Key, Function Keys and All Keys. The IP phone will not be locked immediately after the phone lock type is configured. One of the following steps is also needed:

- Long press the pound key when the IP phone is idle.
- Press the phone lock key (if configured) when the IP phone is idle.

In addition to the above steps, you can configure the IP phone to automatically lock the phone after a period of time.

Procedure

Phone lock can be configured using the configuration files or locally.

Configuration File	<y0000000000xx>.cfg	Configure the phone lock type. Parameters: phone_setting.phone_lock.enable phone_setting.phone_lock.lock_key_type Change the unlock PIN. Parameter: phone_setting.phone_lock.unlock_pin Configure the IP phone to automatically lock
---------------------------	---------------------	---

		<p>the phone after a time interval.</p> <p>Parameter: phone_setting.phone_lock.lock_time_out</p> <p>Configure emergency numbers.</p> <p>Parameter: phone_setting.emergency.number</p> <p>Assign a phone lock key.</p> <p>Parameter: linekey.X.type/ programablekey.X.type/ expansion_module.X.key.Y.type linekey.X.label/ programablekey.X.label/ expansion_module.X.key.Y.label</p>
Local	Web User Interface	<p>Configure the phone lock type.</p> <p>Change the unlock PIN.</p> <p>Configure the IP phone to automatically lock the phone after a time interval.</p> <p>Configure emergency numbers.</p> <p>Navigate to: <a href="http://<phoneIPAddress>/servlet?p=feature-s-phonelock&q=load">http://<phoneIPAddress>/servlet?p=feature-s-phonelock&q=load</p> <p>Assign a phone lock key.</p> <p>Navigate to: <a href="http://<phoneIPAddress>/servlet?p=dsskey&q=load&model=0">http://<phoneIPAddress>/servlet?p=dsskey&q=load&model=0</p>
	Phone User Interface	<p>Configure the phone lock type.</p> <p>Change the unlock PIN.</p> <p>Configure the IP phone to automatically lock the phone after a time interval.</p> <p>Assign a phone lock key.</p>

Details of Configuration Parameters:

Parameters	Permitted Values	Default
phone_setting.phone_lock.enable	0 or 1	0
<p>Description: Enables or disables the phone lock feature.</p> <p>0-Disabled</p>		

Parameters	Permitted Values	Default
<p>1-Enabled</p> <p>Web User Interface: Features->Phone Lock->Phone Lock Enable</p> <p>Phone User Interface: Menu->Settings->Advanced Settings (default password: admin) ->Phone Lock->Lock Enable</p>		
phone_setting.phone_lock.lock_key_type	0, 1 or 2	0
<p>Description: Configures the type of phone lock.</p> <p>0-All Keys 1-Function Keys 2-Menu Keys</p> <p>For more information, refer to Phone Lock Type on page 677.</p> <p>Note: It is not applicable to SIP-T48G IP phones. It works only if the value of the parameter "phone_setting.phone_lock.enable" is set to 1(Enabled).</p> <p>Web User Interface: Features->Phone Lock->Phone Lock Type</p> <p>Phone User Interface: Menu->Settings->Advanced Settings (default password: admin) ->Phone Lock->Lock Type</p>		
phone_setting.phone_lock.unlock_pin	Characters within 15 digits	123
<p>Description: Configures the password for unlocking the phone.</p> <p>Web User Interface: Features->Phone Lock->Phone Unlock PIN (0~15 Digit)</p> <p>Phone User Interface: Menu->Settings->Basic Settings->Change PIN</p>		
phone_setting.phone_lock.lock_time_out	Integer from 0 to 3600	0
<p>Description: Configures the interval (in seconds) to automatically lock the phone. The default value is 0 (the phone is locked only by long pressing the pound key or pressing the phone lock key).</p>		

Parameters	Permitted Values	Default
<p>Note: It works only if the value of the parameter “phone_setting.phone_lock.enable” is set to 1(Enabled).</p> <p>Web User Interface: Features->Phone Lock->Phone Lock Time Out (0~3600s)</p> <p>Phone User Interface: Menu->Settings->Advanced Settings (default password: admin) ->Phone Lock->Lock Time Out</p>		
phone_setting.emergency.number	String within 99 characters	112,911, 110
<p>Description: Configures emergency numbers. Multiple emergency numbers are separated by commas. If the value of the parameter “phone_setting.phone_lock.enable” is set to 1(Enabled) and “phone_setting.phone_lock.lock_key_type” is set to 0 (All Keys), you can only allow to dial emergency numbers configured by “phone_setting.emergency.number”.</p> <p>Web User Interface: Features->Phone Lock->Emergency</p> <p>Phone User Interface: None</p>		

Phone Lock Type

The following table lists the operation behavior when configuring the type of phone lock:

	All Keys	Function Keys	Menu key
Idle screen	<p>Allow Behavior: You are allowed to press the desired Line Key (key type is line) or the Speakerphone key to enter the pre-dialing screen.</p> <p>Keys not Locked: Line keys (key type is line), digit keys, volume key and Speakerphone key.</p>	The same as All Keys.	The Menu key (key type is menu) is locked.
Incoming call	<p>Allow Behavior: You are allowed to answer or reject incoming calls.</p> <p>Keys not Locked: Answer and Reject soft key; OK/√, X, HEADSET, volume</p>	The same as All Keys.	The Menu key (key type is menu) is

	All Keys	Function Keys	Menu key
	key and Speakerphone key.		locked.
Pre-dialing/Dialing screen	<p>Allow Behavior: You are allowed to press the Line Key (key type is line), input or modify numbers, dial emergency numbers and return to idle screen.</p> <p>Keys not Locked: IME, More, Cancel, Send, Delete and Line soft key; line key (key type is line), X, OK/v, volume key, Speakerphone key, digit keys, HEADSET key and "*" / "#" (key as send).</p>	The same as All Keys, but you can dial any number.	The Menu key (key type is menu) is locked.
Talking	<p>Allow Behavior: You are allowed to end the call, initiate a new call to dial the emergency number and hold/resume a call.</p> <p>Keys not Locked: EndCall, Cancel, Resume, NewCall soft key; line key (key type is line), digit keys, X, volume key, MUTE, HEADSET and Speakerphone key.</p> <p>Note: Pressing X key to end the call is not applicable to SIP-T23P/T23G/T21(P) E2/T19(P) E2 IP phones.</p>	The same as All Keys, but you can dial any number.	The Menu key (key type is menu) is locked.

Phone Lock Key

For more information on how to configure the DSS Key, refer to [Appendix D: Configuring DSS Key](#) on page 751.

Parameter	Permitted Values	Default
linekey.X.type/ programmablekey.X.type/ expansion_module.X.key.Y.type	50	Refer to the following content
<p>Description: Configures a DSS key as a phone lock key on the IP phone. The digit 50 stands for the key type Phone Lock. For line keys: X ranges from 1 to 29 (for SIP-T48G) X ranges from 1 to 27 (for SIP-T46G/T29G)</p>		

Parameter	Permitted Values	Default
<p>X ranges from 1 to 15 (for SIPT42G/T41P)</p> <p>X ranges from 1 to 21 (for SIPT27P)</p> <p>X ranges from 1 to 3 (for SIPT23P/G)</p> <p>X ranges from 1 to 2 (for SIPT21(P) E2)</p> <p>For programable keys:</p> <p>X=1-10, 12-14 (for SIPT48G/T46G)</p> <p>X=1-10, 13 (for SIPT42G/T41P)</p> <p>X=1-14 (for SIPT29G/T27P)</p> <p>X=1-10, 14 (for SIPT23P/T23G/T21(P) E2)</p> <p>X=1-9, 13, 14 (for SIPT19(P) E2)</p> <p>For ext keys:</p> <p>X ranges from 1 to 6, Y ranges from 1 to 20, 22 to 40 (Ext key 21 cannot be configured).</p> <p>Example:</p> <p>linekey.1.type = 50</p> <p>Default:</p> <p>For line keys:</p> <p>For SIPT48G IP phones:</p> <p>The default value of the line key 1-16 is 15, and the default value of the line key 17-29 is 0.</p> <p>For SIPT46G/T29G IP phones:</p> <p>The default value of the line key 1-16 is 15, and the default value of the line key 17-27 is 0.</p> <p>For SIPT42G IP phones:</p> <p>The default value of the line key 1-12 is 15, and the default value of the line key 13-15 is 0.</p> <p>For SIPT41P IP phones:</p> <p>The default value of the line key 1-6 is 15, and the default value of the line key 7-15 is 0.</p> <p>For SIPT27P IP phones:</p> <p>The default value of the line key 1-6 is 15, and the default value of the line key 7-21 is 0.</p> <p>For SIPT23P/T23G/T21(P) E2 IP phones:</p> <p>The default value is 15.</p> <p>For programable keys:</p> <p>For SIPT48G/T46G IP phones:</p>		

Parameter	Permitted Values	Default
<p>When X=1, the default value is 28 (History).</p> <p>When X=2, the default value is 61 (Directory).</p> <p>When X=3, the default value is 5 (DND).</p> <p>When X=4, the default value is 30 (Menu).</p> <p>When X=5, the default value is 28 (History).</p> <p>When X=6, the default value is 61 (Directory).</p> <p>When X=7, the default value is 0 (NA).</p> <p>When X=8, the default value is 0 (NA).</p> <p>When X=9, the default value is 33 (Status).</p> <p>When X=10, the default value is 0 (NA).</p> <p>When X=12, the default value is 0 (NA).</p> <p>When X=13, the default value is 0 (NA).</p> <p>When X=14, the default value is 2 (Forward).</p> <p>For SIP-T42G/T41P IP phones:</p> <p>When X=1, the default value is 28 (History).</p> <p>When X=2, the default value is 61 (Directory).</p> <p>When X=3, the default value is 5 (DND).</p> <p>When X=4, the default value is 30 (Menu).</p> <p>When X=5, the default value is 28 (History).</p> <p>When X=6, the default value is 61 (Directory).</p> <p>When X=7, the default value is 0 (NA).</p> <p>When X=8, the default value is 0 (NA).</p> <p>When X=9, the default value is 33 (Status).</p> <p>When X=10, the default value is 0 (NA).</p> <p>When X=13, the default value is 0 (NA).</p> <p>For SIP-T29G/T27P IP phones:</p> <p>When X=1, the default value is 28 (History).</p> <p>When X=2, the default value is 61 (Directory).</p> <p>When X=3, the default value is 5 (DND).</p> <p>When X=4, the default value is 30 (Menu).</p> <p>When X=5, the default value is 28 (History).</p> <p>When X=6, the default value is 61 (Directory).</p> <p>When X=7, the default value is 0 (NA).</p> <p>When X=8, the default value is 0 (NA).</p> <p>When X=9, the default value is 33 (Status).</p>		

Parameter	Permitted Values	Default
<p>When X=10, the default value is 0 (NA).</p> <p>When X=11, the default value is 0 (NA).</p> <p>When X=12, the default value is 0 (NA).</p> <p>When X=13, the default value is 0 (NA).</p> <p>When X=14, the default value is 2 (Forward).</p> <p>For SIP-T23P/T23G/T21 (P) E2 IP phones:</p> <p>When X=1, the default value is 28 (History).</p> <p>When X=2, the default value is 61 (Directory).</p> <p>When X=3, the default value is 5 (DND).</p> <p>When X=4, the default value is 30 (Menu).</p> <p>When X=5, the default value is 28 (History).</p> <p>When X=6, the default value is 61 (Directory).</p> <p>When X=7, the default value is 0 (NA).</p> <p>When X=8, the default value is 0 (NA).</p> <p>When X=9, the default value is 33 (Status).</p> <p>When X=10, the default value is 0 (NA).</p> <p>When X=14, the default value is 2 (Forward).</p> <p>For SIP-T19(P) E2 IP phones:</p> <p>When X=1, the default value is 28 (History).</p> <p>When X=2, the default value is 61 (Directory).</p> <p>When X=3, the default value is 5 (DND).</p> <p>When X=4, the default value is 30 (Menu).</p> <p>When X=5, the default value is 28 (History).</p> <p>When X=6, the default value is 61 (Directory).</p> <p>When X=7, the default value is 0 (NA).</p> <p>When X=8, the default value is 0 (NA).</p> <p>When X=9, the default value is 33 (Status).</p> <p>When X=13, the default value is 0 (NA).</p> <p>When X=14, the default value is 2 (Forward).</p> <p>Web User Interface:</p> <p>DSSKey->Line Key/ Programable Key->Type</p> <p>Phone User Interface:</p> <p>Menu->Features->DSS Keys->Line Keys X->Type</p>		
<p>linekey.X.label/ programablekey.X.label/</p>	<p>String within 99 characters</p>	<p>Blank</p>

Parameter	Permitted Values	Default
expansion_module.X.key.Y.label		
<p>Description: (Optional.) Configures the label displayed on the LCD screen for each DSS key. For line keys: X ranges from 1 to 29 (for SIP-T48G) X ranges from 1 to 27 (for SIP-T46G/T29G) X ranges from 1 to 15 (for SIP-T42G/T41P) X ranges from 1 to 21 (for SIP-T27P) X ranges from 1 to 3 (for SIP-T23P/G) X ranges from 1 to 2 (for SIP-T21(P) E2) For programmable keys: X ranges from 1 to 4. For ext keys: X ranges from 1 to 6, Y ranges from 1 to 20, 22 to 40 (Ext key 21 cannot be configured).</p> <p>Web User Interface: DSSKey->Line Key/Programable Key->Label</p> <p>Phone User Interface: Menu->Features->DSS Keys->Line Key X->Label</p>		

To configure phone lock via web user interface:

1. Click on **Features->Phone Lock**.
2. Select the desired value from the pull-down list of **Phone Lock Enable**.
3. Select the desired value from the pull-down list of **Phone Lock Type**.
4. Enter the unlock PIN in the **Phone Unlock PIN (0~15 Digit)** field.
5. Enter the desired time in the **Phone Lock Time Out (0~3600s)** field.

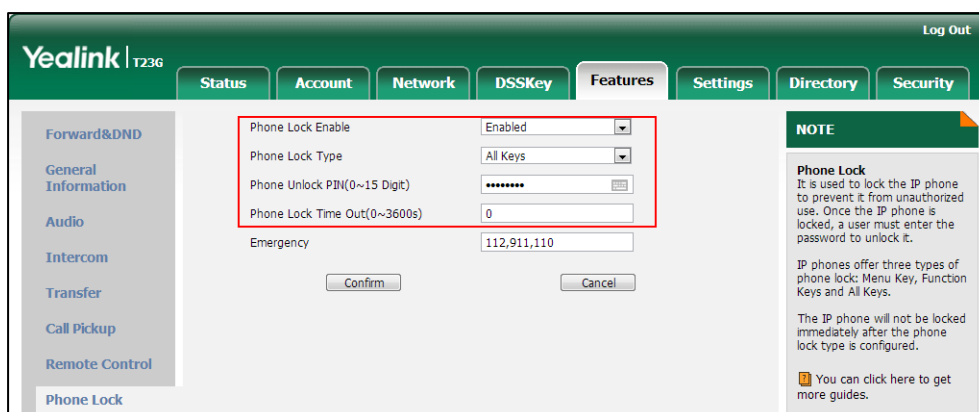

6. Click **Confirm** to accept the change.

To configure a phone lock key via web user interface:

1. Click on **DSSKey->Line Key** (or **Programable Key**).
2. In the desired DSS key field, select **Phone Lock** from the pull-down list of **Type**.
3. (Optional.) Enter the string that will appear on the LCD screen in the **Label** field.

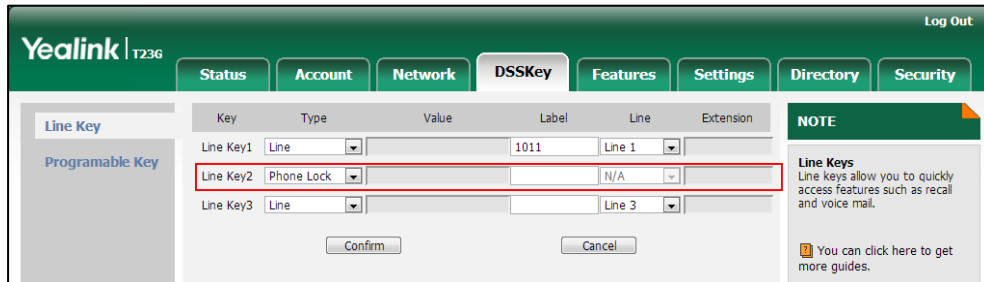

4. Click **Confirm** to accept the change.

To configure the type of phone lock via phone user interface:

1. Press **Menu->Settings->Advanced Settings** (default password: admin) ->**Phone Lock**.
2. Press **◀** or **▶**, or the **Switch** soft key to select the desired value from the **Lock Enable** field.
3. Press **◀** or **▶**, or the **Switch** soft key to select the desired value from the **Lock Type** field.
4. Enter the desired interval of automatic phone lock in the **Lock Time Out** field.
5. Press the **Save** soft key to accept the change.

To change the unlock PIN via phone user interface:

1. Press **Menu->Settings->Basic Settings->Change PIN**.
2. Enter the current unlock PIN in the **Current PIN** field.
3. Enter the new unlock PIN in the **New PIN** field.
4. Enter the new unlock PIN again in the **Confirm PIN** field.
5. Press the **Save** soft key to accept the change.

To configure a phone lock key via phone user interface:

1. Press **Menu->Features->DSS Keys**.
2. Select the desired DSS key.
3. Press **◀** or **▶**, or the **Switch** soft key to select **Phone Lock** from the **Type** field.
4. (Optional.) Enter the string that will appear on the LCD screen in the **Label** field.
5. Press the **Save** soft key to accept the change.

Transport Layer Security

TLS is a commonly-used protocol for providing communications privacy and managing the security of message transmission, allowing IP phones to communicate with other remote parties and connect to the HTTPS URL for provisioning in a way that is designed to prevent eavesdropping and tampering.

TLS protocol is composed of two layers: TLS Record Protocol and TLS Handshake Protocol. The TLS Record Protocol completes the actual data transmission and ensures the integrity and privacy of the data. The TLS Handshake Protocol allows the server and client to authenticate each other and negotiate an encryption algorithm and cryptographic keys before data is exchanged.

The TLS protocol uses asymmetric encryption for authentication of key exchange, symmetric encryption for confidentiality, and message authentication codes for integrity.

- **Symmetric encryption:** For symmetric encryption, the encryption key and the corresponding decryption key can be told by each other. In most cases, the encryption key is the same as the decryption key.
- **Asymmetric encryption:** For asymmetric encryption, each user has a pair of cryptographic keys – a public encryption key and a private decryption key. The information encrypted by the public key can only be decrypted by the corresponding private key and vice versa. Usually, the receiver keeps its private key. The public key is known by the sender, so the sender sends the information encrypted by the known public key, and then the receiver uses the private key to decrypt it.

IP phones support TLS version 1.0. A cipher suite is a named combination of authentication, encryption, and message authentication code (MAC) algorithms used to negotiate the security settings for a network connection using the TLS/SSL network protocol. IP phones support the following cipher suites:

- DHE-RSA-AES256-SHA
- DHE-DSS-AES256-SHA
- AES256-SHA
- EDH-RSA-DES-CBC3-SHA
- EDH-DSS-DES-CBC3-SHA
- DES-CBC3-SHA
- DHE-RSA-AES128-SHA
- DHE-DSS-AES128-SHA
- AES128-SHA
- IDEA-CBC-SHA
- DHE-DSS-RC4-SHA
- RC4-SHA

- RC4-MD5
- EXP1024-DHE-DSS-DES-CBC-SHA
- EXP1024-DES-CBC-SHA
- EDH-RSA-DES-CBC-SHA
- EDH-DSS-DES-CBC-SHA
- DES-CBC-SHA
- EXP1024-DHE-DSS-RC4-SHA
- EXP1024-RC4-SHA
- EXP1024-RC4-MD5
- EXP-EDH-RSA-DES-CBC-SHA
- EXP-EDH-DSS-DES-CBC-SHA
- EXP-DES-CBC-SHA
- EXP-RC4-MD5

The following figure illustrates the TLS messages exchanged between the IP phone and TLS server to establish an encrypted communication channel:

No.	Time	Source	Destination	Protocol	Info
1	0.000000	192.168.3.86	192.168.0.230	SSLV3	Client Hello
2	0.021345	192.168.0.230	192.168.3.86	SSLV3	Server Hello, Certificate, Server Key Exchange, Server Hello Done
3	0.954947	192.168.3.86	192.168.0.230	SSLV3	Client Key Exchange, Change Cipher Spec, Encrypted Handshake Message
4	0.970099	192.168.0.230	192.168.3.86	SSLV3	Change Cipher Spec, Encrypted Handshake Message
5	1.012295	192.168.3.86	192.168.0.230	SSLV3	Application Data, Application Data
6	1.013562	192.168.0.230	192.168.3.86	SSLV3	Application Data
7	1.013667	192.168.0.230	192.168.3.86	SSLV3	Application Data

Frame 13: 652 bytes on wire (5216 bits), 652 bytes captured (5216 bits)

Ethernet II, Src: VMware_72:c9:2e (00:0c:29:72:c9:2e), Dst: Xiamenve_11:12:b7 (00:15:65:11:12:b7)

Internet Protocol, Src: 192.168.0.230 (192.168.0.230), Dst: 192.168.3.86 (192.168.3.86)

Transmission Control Protocol, Src Port: https (443), Dst Port: nmserver (2244), Seq: 1482, Ack: 437, Len: 586

Secure Socket Layer

Step1: IP phone sends “Client Hello” message proposing SSL options.

Step2: Server responds with “Server Hello” message selecting the SSL options, sends its public key information in “Server Key Exchange” message and concludes its part of the negotiation with “Server Hello Done” message.

Step3: IP phone sends session key information (encrypted by server’s public key) in the “Client Key Exchange” message.

Step4: Server sends “Change Cipher Spec” message to activate the negotiated options for all future messages it will send.

IP phones can encrypt SIP with TLS, which is called SIPS. When TLS is enabled for an account, the SIP message of this account will be encrypted, and a lock icon appears on the LCD screen after the successful TLS negotiation.

Certificates

The IP phone can serve as a TLS client or a TLS server. The TLS requires the following security certificates to perform the TLS handshake:

- **Trusted Certificate:** When the IP phone requests a TLS connection with a server, the

IP phone should verify the certificate sent by the server to decide whether it is trusted based on the trusted certificates list. The IP phone has 30 built-in trusted certificates. You can upload 10 custom certificates at most. The format of the trusted certificate files must be *.pem,*.cer,*.crt and *.der and the maximum file size is 5MB. For more information on 30 trusted certificates, refer to [Appendix C: Trusted Certificates](#) on page 750.

- **Server Certificate:** When clients request a TLS connection with the IP phone, the IP phone sends the server certificate to the clients for authentication. The IP phone has two types of built-in server certificates: a unique server certificate and a generic server certificate. You can only upload one server certificate to the IP phone. The old server certificate will be overridden by the new one. The format of the server certificate files must be *.pem and *.cer and the maximum file size is 5MB.
 - **A unique server certificate:** It is unique to an IP phone (based on the MAC address) and issued by the Yealink Certificate Authority (CA).
 - **A generic server certificate:** It issued by the Yealink Certificate Authority (CA). Only if no unique certificate exists, the IP phone may send a generic certificate for authentication.

The IP phone can authenticate the server certificate based on the trusted certificates list. The trusted certificates list and the server certificates list contain the default and custom certificates. You can specify the type of certificates the IP phone accepts: default certificates, custom certificates or all certificates.

Common Name Validation feature enables the IP phone to mandatorily validate the common name of the certificate sent by the connecting server. And Security verification rules are compliant with RFC 2818.

Note

In TLS feature, we use the terms trusted and server certificate. These are also known as CA and device certificates.

Resetting the IP phone to factory defaults will delete custom certificates by default. But this feature is configurable using the configuration files. For more information on the configuration parameter, refer to [Transport Layer Security](#) on page 684.

Procedure

Configuration changes can be performed using the configuration files or locally.

Configuration File	<MAC>.cfg	Configure TLS on a per-line basis. Parameter: account.X.sip_server.Y.transport_type
	<y0000000000xx>.cfg	Configure trusted certificates feature. Parameters: security.trust_certificates

		<p>security.ca_cert</p> <p>security.cn_validation</p> <p>Configure server certificates feature.</p> <p>Parameters:</p> <p>security.dev_cert</p> <p>Upload the trusted certificates.</p> <p>Parameter:</p> <p>trusted_certificates.url</p> <p>Delete all uploaded trusted certificates.</p> <p>Parameter:</p> <p>trusted_certificates.delete</p> <p>Upload the server certificates.</p> <p>Parameter:</p> <p>server_certificates.url</p> <p>Delete all uploaded server certificates.</p> <p>Parameter:</p> <p>server_certificates.delete</p> <p>Configure the custom certificates.</p> <p>Parameter:</p> <p>phone_setting.reserve_certs_enable</p>
<p>Local</p>	<p>Web User Interface</p>	<p>Configure TLS on a per-line basis.</p> <p>Navigate to:</p> <p><a href="http://<phoneIPAddress>/servlet?p=account-register&q=load&acc=0">http://<phoneIPAddress>/servlet?p=account-register&q=load&acc=0</p> <p>Configure trusted certificates feature.</p> <p>Upload the trusted certificates.</p> <p>Navigate to:</p> <p><a href="http://<phoneIPAddress>/servlet?p=trusted-cert&q=load">http://<phoneIPAddress>/servlet?p=trusted-cert&q=load</p> <p>Configure server certificates feature.</p> <p>Upload the server certificates.</p> <p>Navigate to:</p> <p><a href="http://<phoneIPAddress>/servlet?p=server-cert&q=load">http://<phoneIPAddress>/servlet?p=server-cert&q=load</p>

Details of Configuration Parameters:

Parameters	Permitted Values	Default
account.X.sip_server.Y.transport_type (X ranges from 1 to 16, Y ranges from 1 to 2)	0,1,2 or 3	0
<p>Description: Configures the type of transport protocol for account X.</p> <p>0-UDP 1-TCP 2-TLS 3-DNS-NAPTR</p> <p>X ranges from 1 to 16 (for SIP-T48G/T46G/T29G) X ranges from 1 to 12 (for SIP-T42G) X ranges from 1 to 6 (for SIP-T41P/T27P) X ranges from 1 to 3 (for SIP-T23P/G) X ranges from 1 to 2 (for SIP-T21(P) E2) X is equal to 1 (for SIP-T19(P) E2)</p> <p>Web User Interface: Account->Register->SIP Server Y->Transport</p> <p>Phone User Interface: None</p>		
security.trust_certificates	0 or 1	1
<p>Description: Enables or disables the IP phone to only trust the server certificates in the Trusted Certificates list.</p> <p>0-Disabled 1-Enabled</p> <p>If it is set to 0 (Disabled), the IP phone will trust the server no matter whether the certificate sent by the server is valid or not.</p> <p>If it is set to 1 (Enabled), the IP phone will authenticate the server certificate based on the trusted certificates list. Only when the authentication succeeds, the IP phone will trust the server.</p> <p>Note: If you change this parameter, the IP phone will reboot to make the change take effect.</p> <p>Web User Interface:</p>		

Parameters	Permitted Values	Default
Security->Trusted Certificates->Only Accept Trusted Certificates Phone User Interface: None		
security.ca_cert	0, 1 or 2	2
Description: Configures the type of certificates in the Trusted Certificates list for the IP phone to authenticate for TLS connection. 0 -Default Certificates 1 -Custom Certificates 2 -All Certificates Note: If you change this parameter, the IP phone will reboot to make the change take effect. Web User Interface: Security->Trusted Certificates->CA Certificates Phone User Interface: None		
security.cn_validation	0 or 1	0
Description: Enables or disables the IP phone to mandatorily validate the CommonName or SubjectAltName of the certificate sent by the server. 0 -Disabled 1 -Enabled Note: If you change this parameter, the IP phone will reboot to make the change take effect. Web User Interface: Security->Trusted Certificates->Common Name Validation Phone User Interface: None		
security.dev_cert	0 or 1	0
Description: Configures the type of the device certificates for the IP phone to send for TLS		

Parameters	Permitted Values	Default
<p>authentication.</p> <p>0-Default Certificates 1-Custom Certificates</p> <p>Note: If you change this parameter, the IP phone will reboot to make the change take effect.</p> <p>Web User Interface: Security->Server Certificates->Device Certificates</p> <p>Phone User Interface: None</p>		
trusted_certificates.url	URL within 511 characters	Blank
<p>Description: Configures the access URL of the custom trusted certificate used to authenticate the connecting server.</p> <p>Example: trusted_certificates.url = http://192.168.1.20/tc.crt</p> <p>Note: The certificate you want to upload must be in *.pem, *.crt, *.cer or *.der format.</p> <p>Web User Interface: Security->Trusted Certificates->Load trusted certificates file</p> <p>Phone User Interface: None</p>		
trusted_certificates.delete	http://localhost/all	Blank
<p>Description: Deletes all uploaded trusted certificates.</p> <p>Example: trusted_certificates.delete = http://localhost/all</p> <p>Web User Interface: None</p> <p>Phone User Interface: None</p>		
server_certificates.url	URL within 511 characters	Blank

Parameters	Permitted Values	Default
<p>Description: Deletes all uploaded trusted certificates.</p> <p>Example: trusted_certificates.delete = http://localhost/all</p> <p>Web User Interface: None</p> <p>Phone User Interface: None</p>		
server_certificates.delete	http://localhost/all	Blank
<p>Description: Deletes all uploaded server certificates.</p> <p>Example: server_certificates.delete = http://localhost/all</p> <p>Web User Interface: None</p> <p>Phone User Interface: None</p>		
phone_setting.reserve_certs_enable	0 or 1	0
<p>Description: Enables or disables the IP phone to reserve custom certificates after it is reset to factory defaults.</p> <p>0-Disabled 1-Enabled</p> <p>Web User Interface: None</p> <p>Phone User Interface: None</p>		

To configure TLS on a per-line basis via web user interface:

1. Click on **Account->Register**.
2. Select the desired account from the pull-down list of **Account**.

3. Select **TLS** from the pull-down list of **Transport**.

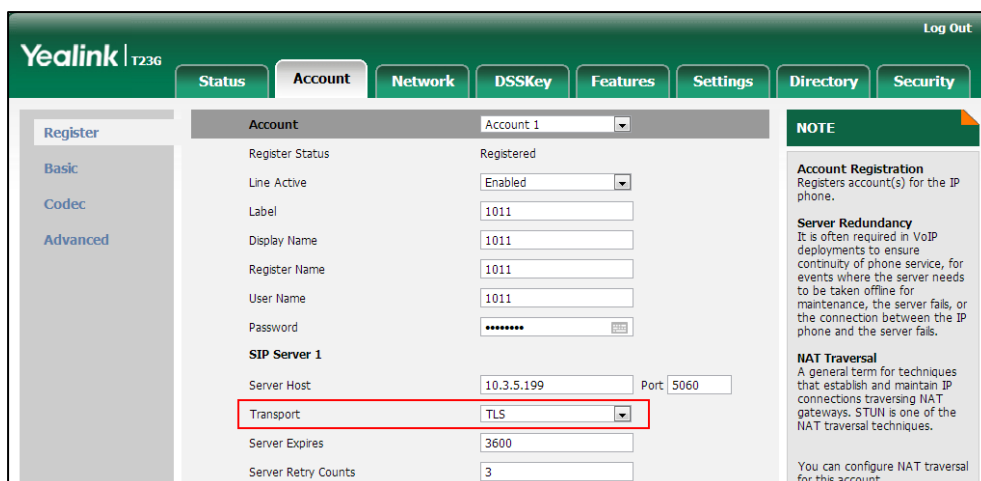

4. Click **Confirm** to accept the change.

To configure the trusted certificates via web user interface:

1. Click on **Security->Trusted Certificates**.
2. Select the desired values from the pull-down lists of **Only Accept Trusted Certificates**, **Common Name Validation** and **CA Certificates**.

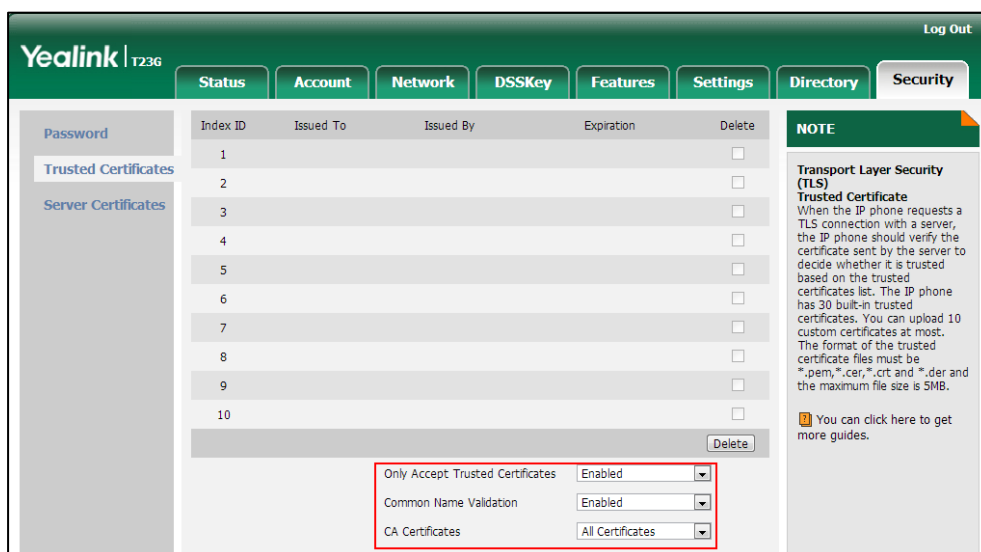

3. Click **Confirm** to accept the change.

To upload a trusted certificate via web user interface:

1. Click on **Security->Trusted Certificates**.

- Click **Browse** to select the certificate (*.pem, *.crt, *.cer or *.der) from your local system.

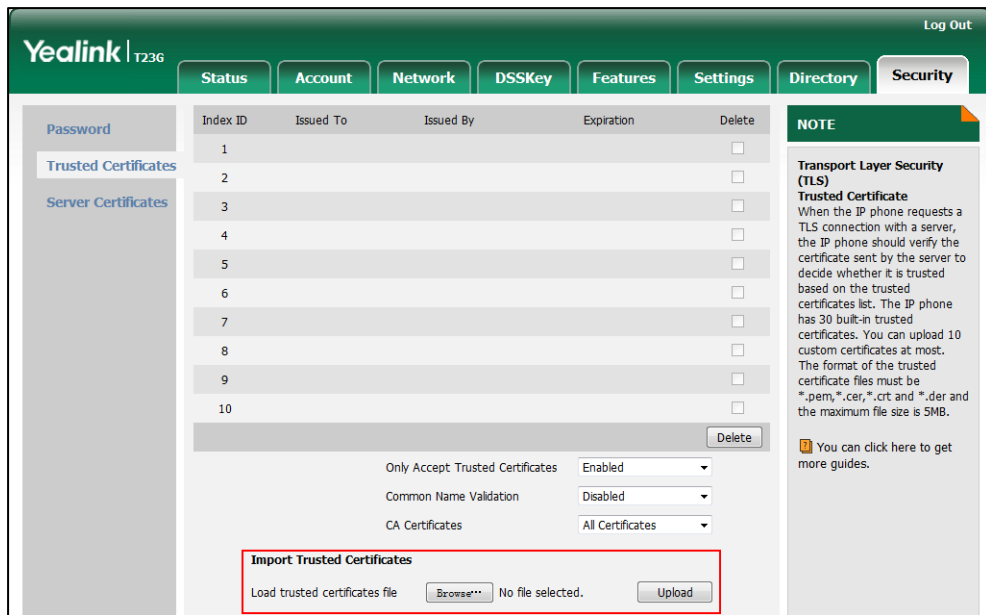

- Click **Upload** to upload the certificate.

To configure the server certificates via web user interface:

- Click on **Security->Server Certificates**.
- Select the desired value from the pull-down list of **Device Certificates**.

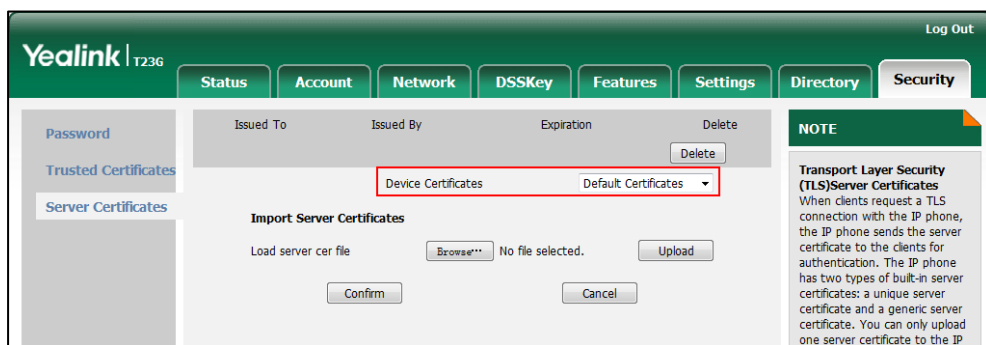

- Click **Confirm** to accept the change.

To upload a server certificate via web user interface:

- Click on **Security->Server Certificates**.

- Click **Browse** to select the certificate (*.pem and *.cer) from your local system.

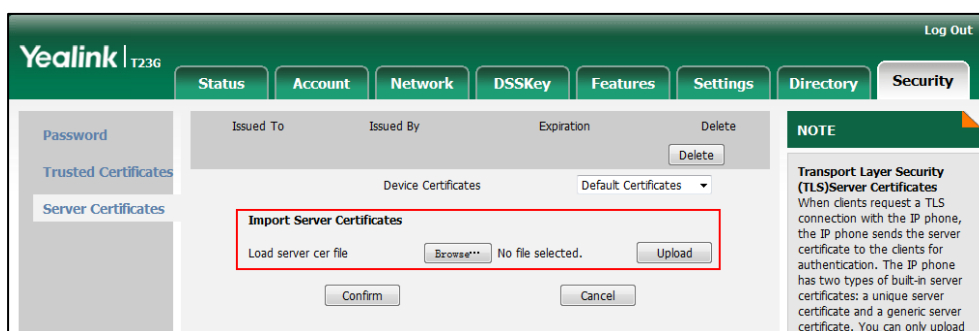

- Click **Upload** to upload the certificate.

A dialog box pops up to prompt "Success: The Server Certificate has been loaded! Rebooting, please wait...".

Secure Real-Time Transport Protocol

Secure Real-Time Transport Protocol (SRTP) encrypts the RTP during VoIP phone calls to avoid interception and eavesdropping. The parties participating in the call must enable SRTP feature simultaneously. When this feature is enabled on both phones, the type of encryption to utilize for the session is negotiated between the IP phones. This negotiation process is compliant with [RFC 4568](#).

When a user places a call on the enabled SRTP phone, the IP phone sends an INVITE message with the RTP encryption algorithm to the destination phone. As described in [RFC 3711](#), RTP streams may be encrypted using an AES (advanced encryption standard) algorithm.

Example of the RTP encryption algorithm carried in the SDP of the INVITE message:

```
m=audio 11780 RTP/SAVP 0 8 18 9 101
a=crypto:1 AES_CM_128_HMAC_SHA1_80
inline:NzFINTUwZDk2OGVIOTc3YzNkYTkWZWVhMTM1YWFj
a=crypto:2 AES_CM_128_HMAC_SHA1_32
inline:NzkyM2FjNzQ2ZDgxYjg0MzQwMGVhMGUxMzdmNWFm
a=crypto:3 F8_128_HMAC_SHA1_80 inline:NDliMWIzZGE1ZTAwZjA5ZGFhNjQ5YmEANTMzYzA0
a=rtpmap:0 PCMU/8000
a=rtpmap:8 PCMA/8000
a=rtpmap:18 G729/8000
a=fmtp:18 annexb=no
a=rtpmap:9 G722/8000
a=fmtp:101 0-15
a=rtpmap:101 telephone-event/8000
a=ptime:20
```

```
a=sendrecv
```

The callee receives the INVITE message with the RTP encryption algorithm, and then answers the call by responding with a 200 OK message which carries the negotiated RTP encryption algorithm.

Example of the RTP encryption algorithm carried in the SDP of the 200 OK message:

```
m=audio 11780 RTP/SAVP 0 101
a=rtpmap:0 PCMU/8000
a=rtpmap:101 telephone-event/8000
a=crypto:1 AES_CM_128_HMAC_SHA1_80
inline:NGY4OGViMDYzZjQzYTNiOTNkOWRiYzRiMjM0Yzcz
a=sendrecv
a=ptime:20
a=fmtp:101 0-15
```

SRTP is configurable on a per-line basis. When SRTP is enabled on both IP phones, RTP streams will be encrypted, and a lock icon appears on the LCD screen of each IP phone after successful negotiation.

Note

If you enable SRTP, then you should also enable TLS. This ensures the security of SRTP encryption. For more information on TLS, refer to [Transport Layer Security](#) on page 684.

Procedure

SRTP can be configured using the configuration files or locally.

Configuration File	<MAC>.cfg	Configure SRTP feature on a per-line basis. Parameter: account.X.srtp_encryption
Local	Web User Interface	Configure SRTP feature on a per-line basis. Navigate to: http://<phoneIPAddress>/servlet?p=account-adv&q=load&acc=0

Details of the Configuration Parameter:

Parameters	Permitted Values	Default
account.X.srtp_encryption	0, 1 or 2	0

Parameters	Permitted Values	Default
<p>Description: Configures whether to use voice encryption service for account X.</p> <p>0-Disabled 1-Optional 2-Compulsory</p> <p>If it is set to 1 (Optional), the IP phone will negotiate with the other IP phone what type of encryption to utilize for the session.</p> <p>If it is set to 2 (Compulsory), the IP phone is forced to use SRTP during a call.</p> <p>X ranges from 1 to 16 (for SIP-T48G/T46G/T29G) X ranges from 1 to 12 (for SIP-T42G) X ranges from 1 to 6 (for SIP-T41P/T27P) X ranges from 1 to 3 (for SIP-T23P/G) X ranges from 1 to 2 (for SIP-T21(P) E2) X is equal to 1 (for SIP-T19(P) E2)</p> <p>Web User Interface: Account->Advanced->RTP Encryption(SRTP)</p> <p>Phone User Interface: None</p>		

To configure SRTP feature via web user interface:

1. Click on **Account->Advanced**.
2. Select the desired account from the pull-down list of **Account**.

3. Select the desired value from the pull-down list of **RTP Encryption(SRTP)**.

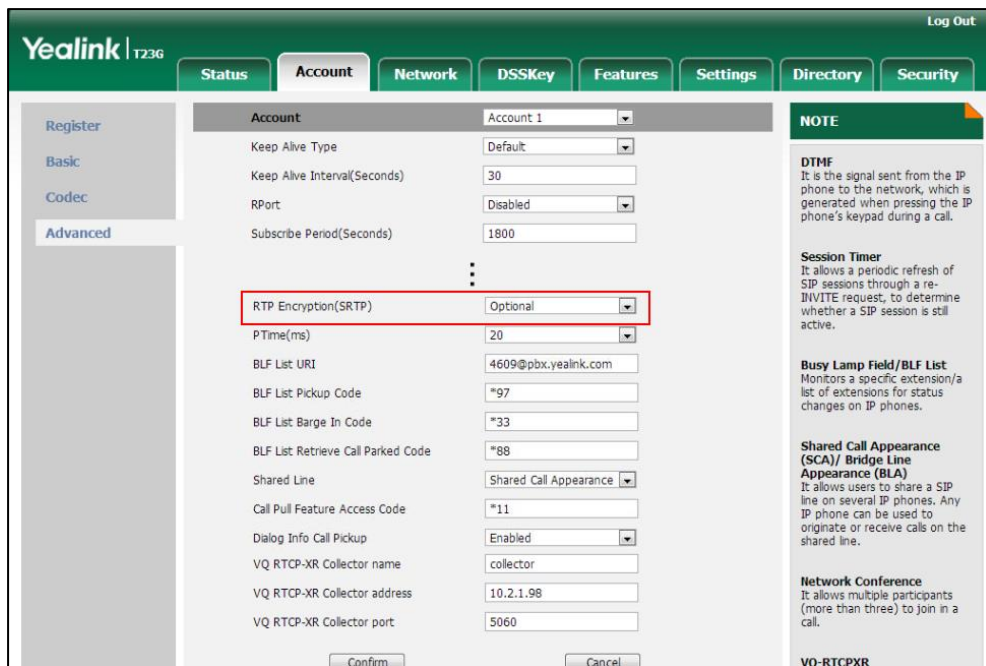

4. Click **Confirm** to accept the change.

Encrypting Configuration Files

Encrypted configuration files can be downloaded from the provisioning server to protect against unauthorized access and tampering of sensitive information (e.g., login passwords, registration information). Yealink supplies a configuration encryption tool for encrypting configuration files. The encryption tool encrypts plaintext <y0000000000xx>.cfg and <MAC>.cfg files (one by one or in batch) using 16-character symmetric keys (the same or different keys for configuration files) and generates encrypted configuration files with the same file name as before. This tool also encrypts the plaintext 16-character symmetric keys using a fixed key, which is the same as the one built in the IP phone, and generates new files named as <xx_Security>.enc (xx indicates the name of the Line configuration file, for example, y000000000044_Security.enc for y000000000044.cfg file). This tool generates another new file named as Aeskey.txt to store the plaintext 16-character symmetric keys for each configuration file.

For a Microsoft Windows platform, you can use a Yealink-supplied encryption tool "Config_Encrypt_Tool.exe" to encrypt the <y0000000000xx>.cfg and <MAC>.cfg files respectively.

Note Yealink also supplies a configuration encryption tool (yealinkencrypt) for Linux platform if required. For more information, refer to [Yealink Configuration Encryption Tool User Guide](#).

For security reasons, administrator should upload encrypted configuration files,

<y0000000000xx_Security>.enc and/or <MAC_Security>.enc files to the root directory of the provisioning server. During auto provisioning, the IP phone requests to download <y0000000000xx>.cfg file first. If the downloaded configuration file is encrypted, the IP phone will request to download <y0000000000xx_Security>.enc file (if enabled) and decrypt it into the plaintext key (e.g., key2) using the built-in key (e.g., key1). Then the IP phone decrypts <y0000000000xx>.cfg file using key2. After decryption, the IP phone resolves configuration files and updates configuration settings onto the IP phone system.

The way the IP phone processes the <MAC>.cfg file is the same to that of the <y0000000000xx>.cfg file.

Procedure to Encrypt Configuration Files

To encrypt the <y0000000000xx>.cfg file:

1. Double click "Config_Encrypt_Tool.exe" to start the application tool.

The screenshot of the main page is shown as below:



When you start the application tool, a file folder named "Encrypted" is created automatically in the directory where the application tool is located.

2. Click **Browse** to locate configuration file(s) (e.g., y000000000044.cfg) from your local system in the **Select File(s)** field.

To select multiple configuration files, you can select the first file and then press and hold the **Ctrl** key and select the next files.

3. (Optional.) Click **Browse** to locate the target directory from your local system in the **Target Directory** field.

The tool uses the file folder "Encrypted" as the target directory by default.

4. (Optional.) Mark the desired radio box in the **AES Model** field.

If you mark the **Manual** radio box, you can enter an AES key in the **AES KEY** field or click **Re-Generate** to generate an AES key in the **AES KEY** field. The configuration file(s) will be encrypted using the AES key in the **AES KEY** field.

If you mark the **Auto Generate** radio box, the configuration file(s) will be encrypted using random AES key. The AES keys of configuration files are different.

Note

AES keys must be 16 characters and the supported characters contain: 0 ~ 9, A ~ Z, a ~ z and the following special characters are also supported: # \$ % * + , - . : = ? @ [] ^ _ { } ~ .

5. Click **Encrypt** to encrypt the configuration file(s).



6. Click **OK**.

The target directory will be automatically opened. You can find the encrypted CFG file(s), encrypted key file(s) and an Aeskey.txt file storing plaintext AES key(s).

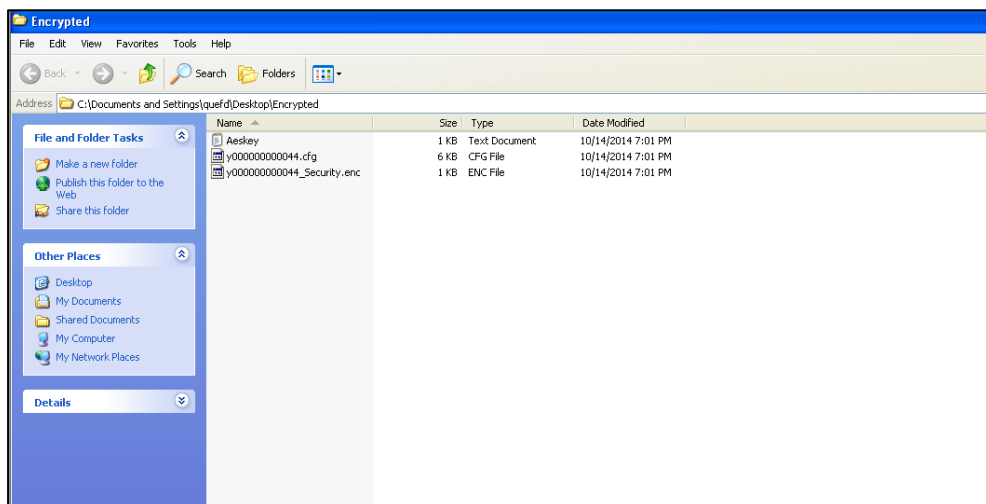

Procedure

Decryption method can be configured using the configuration files.

<p>Configuration File</p>	<p><y0000000000xx>.cfg</p>	<p>Configure the decryption method. Parameter: auto_provision.aes_key_in_file Configure AES keys.</p>
----------------------------------	----------------------------------	---

		Parameters: auto_provision.aes_key_16.com auto_provision.aes_key_16.mac
Local	Web User Interface	Configure AES keys. Navigate to: http://<phoneIPAddress>/servlet?p =settings-autop&q=load
	Phone User Interface	Configure AES keys.

Details of Configuration Parameters:

Parameters	Permitted Values	Default
auto_provision.aes_key_in_file	0 or 1	0
<p>Description:</p> <p>Enables or disables the IP phone to decrypt configuration files using the encrypted AES keys.</p> <p>0-Disabled 1-Enabled</p> <p>If it is set to 1 (Enabled), the IP phone will download <y0000000000xx_Security>.enc and <MAC_Security>.enc files during auto provisioning, and then decrypts these files into the plaintext keys (e.g., key2, key3) respectively using the phone built-in key (e.g., key1). The IP phone then decrypts the encrypted configuration files using corresponding key (e.g., key2, key3).</p> <p>If it is set to 0 (Disabled), the IP phone will decrypt the encrypted configuration files using plaintext AES keys configured on the IP phone.</p> <p>Web User Interface:</p> <p>None</p> <p>Phone User Interface:</p> <p>None</p>		
auto_provision.aes_key_16.com	16 characters	Blank
<p>Description:</p> <p>Configures the plaintext AES key for decrypting the Common CFG file.</p> <p>The valid characters contain: 0 ~ 9, A ~ Z, a ~ z and the following special characters are also supported: # \$ % * + , - . : = ? @ [] ^ _ { } ~.</p> <p>Example:</p>		

Parameters	Permitted Values	Default
<p>auto_provision.aes_key_16.com = 0123456789abcdef</p> <p>Note: It works only if the value of the parameter “auto_provision.aes_key_in_file” is set to 0 (Disabled).</p> <p>Web User Interface: Settings->Auto Provision->Common AES Key</p> <p>Phone User Interface: Menu->Settings->Advanced Settings->Set AES Key->Common</p>		
auto_provision.aes_key_16.mac	16 characters	Blank
<p>Description: Configures the plaintext AES key for decrypting the MAC-Oriented CFG file. The valid characters contain: 0 ~ 9, A ~ Z, a ~ z and the following special characters are also supported: # \$ % * + , - . : = ? @ [] ^ _ { } ~.</p> <p>Example: auto_provision.aes_key_16.mac = 0123456789abmins</p> <p>Note: It works only if the value of the parameter “auto_provision.aes_key_in_file” is set to 0 (Disabled).</p> <p>Web User Interface: Settings->Auto Provision->MAC-Oriented AES Key</p> <p>Phone User Interface: Menu->Settings->Advanced Settings->Set AES Key->MAC-oriented</p>		

To configure AES keys via web user interface:

1. Click on **Settings->Auto Provision**.
2. Enter the values in the **Common AES Key** and **MAC-Oriented AES Key** fields.

AES keys must be 16 characters and the supported characters contain: 0-9, A-Z, a-z and the following special characters are also supported: # \$ % * + , - . : = ? @ [] ^ _ { } ~.

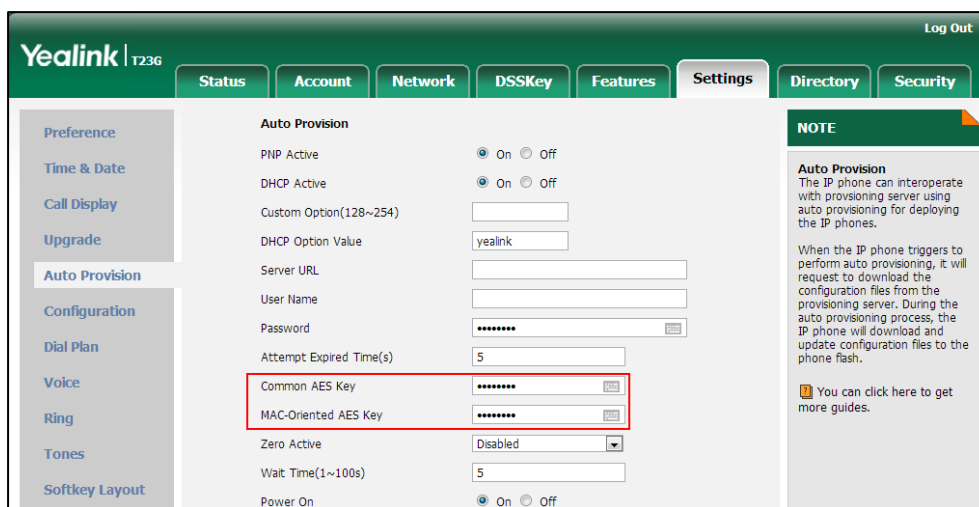

3. Click **Confirm** to accept the change.

To configure AES keys via phone user interface:

1. Press **Menu->Settings->Advanced Settings** (default password: admin) ->**Set AES Key**.
2. Enter the values in the **Common AES Key** and **MAC-Oriented AES Key** fields.

AES keys must be 16 characters and the supported characters contain: 0-9, A-Z, a-z and the following special characters are also supported: # \$ % * + , - . : = ? @ [] ^ _ { } ~.

3. Press the **Save** soft key to accept the change.

802.1X Authentication

IEEE 802.1X authentication is an IEEE standard for Port-based Network Access Control (PNAC), part of the IEEE 802.1 group of networking protocols. It offers an authentication mechanism for devices to connect/link to a LAN or WLAN. The 802.1X authentication involves three parties: a supplicant, an authenticator and an authentication server. The supplicant is the IP phone that wishes to attach to the LAN or WLAN. With 802.1X port-based authentication, the IP phone provides credentials, such as user name and password, for the authenticator, and then the authenticator forwards the credentials to the authentication server for verification. If the authentication server determines the credentials are valid, the IP phone is allowed to access resources located on the protected side of the network.

IP phones support protocols EAP-MD5, EAP-TLS, EAP-PEAP/MSCHAPv2, EAP-TTLS/EAP-MSCHAPv2, EAP-PEAP/GTC, EAP-TTLS/EAP-GTC and EAP-FAST for 802.1X authentication.

For more information on 802.1X authentication, refer to [Yealink 802.1X Authentication](#).

Procedure

802.1X authentication can be configured using the configuration files or locally.

Configuration File	<y0000000000xx>.cfg	Configure the 802.1X authentication. Parameters: network.802_1x.mode network.802_1x.identity network.802_1x.md5_password network.802_1x.root_cert_url network.802_1x.client_cert_url
Local	Web User Interface	Configure the 802.1X authentication. Navigate to: http://<phoneIPAddress>/servlet?p=network-adv&q=load
	Phone User Interface	Configure the 802.1X authentication.

Details of Configuration Parameters:

Parameters	Permitted Values	Default
network.802_1x.mode	0, 1, 2, 3, 4, 5, 6 or 7	0
<p>Description: Configures the 802.1x authentication method.</p> <p>0-Disabled 1-EAP-MD5 2-EAP-TLS 3-EAP-PEAP/MSCHAPv2 4-EAP-TTLS/EAP-MSCHAPv2 5-EAP-PEAP/GTC 6-EAP-TTLS/EAP-GTC 7-EAP-FAST</p> <p>Note: If you change this parameter, the IP phone will reboot to make the change take effect.</p>		

Parameters	Permitted Values	Default
<p>Web User Interface: Network->Advanced->802.1x->802.1x Mode</p> <p>Phone User Interface: Menu->Settings->Advanced Settings (default password: admin) ->Network->802.1x Settings->802.1x Mode</p>		
network.802_1x.identity	String within 32 characters	Blank
<p>Description: Configures the user name for 802.1x authentication.</p> <p>Example: network.802_1x.identity = admin</p> <p>Note: It works only if the value of the parameter "network.802_1x.mode" is set to 1, 2, 3, 4, 5, 6 or 7. If you change this parameter, the IP phone will reboot to make the change take effect.</p> <p>Web User Interface: Network->Advanced->802.1x->Identity</p> <p>Phone User Interface: Menu->Settings->Advanced Settings (default password: admin) ->Network->802.1x Settings->Identity</p>		
network.802_1x.md5_password	String within 32 characters	Blank
<p>Description: Configures the password for 802.1x authentication.</p> <p>Example: network.802_1x.md5_password = admin123</p> <p>Note: It works only if the value of the parameter "network.802_1x.mode" is set to 1, 3, 4, 5, 6 or 7. If you change this parameter, the IP phone will reboot to make the change take effect.</p> <p>Web User Interface: Network->Advanced->802.1x->MD5 Password</p> <p>Phone User Interface: Menu->Settings->Advanced Settings (default password: admin) ->Network->802.1x Settings->MD5 Password</p>		
network.802_1x.root_cert_url	URL within 511 characters	Blank

Parameters	Permitted Values	Default
<p>Description: Configures the access URL of the CA certificate.</p> <p>Example: network.802_1x.root_cert_url = http://192.168.1.10/ca.pem</p> <p>Note: It works only if the value of the parameter "network.802_1x.mode" is set to 2, 3, 4, 5, 6 or 7. The format of the certificate must be *.pem, *.crt, *.cer or *.der.</p> <p>Web User Interface: Network->Advanced->802.1x->CA Certificates</p> <p>Phone User Interface: None</p>		
network.802_1x.client_cert_url	URL within 511 characters	Blank
<p>Description: Configures the access URL of the device certificate.</p> <p>Example: network.802_1x.client_cert_url = http://192.168.1.10/client.pem</p> <p>Note: It works only if the value of the parameter "network.802_1x.mode" is set to 2 (EAP-TLS). The format of the certificate must be *.pem.</p> <p>Web User Interface: Network->Advanced->802.1x->Device Certificates</p> <p>Phone User Interface: None</p>		

To configure the 802.1X authentication via web user interface:

1. Click on **Network->Advanced**.
2. In the **802.1x** block, select the desired protocol from the pull-down list of **802.1x Mode**.
 - a) If you select **EAP-MD5**:
 - 1) Enter the user name for authentication in the **Identity** field.

2) Enter the password for authentication in the **MD5 Password** field.

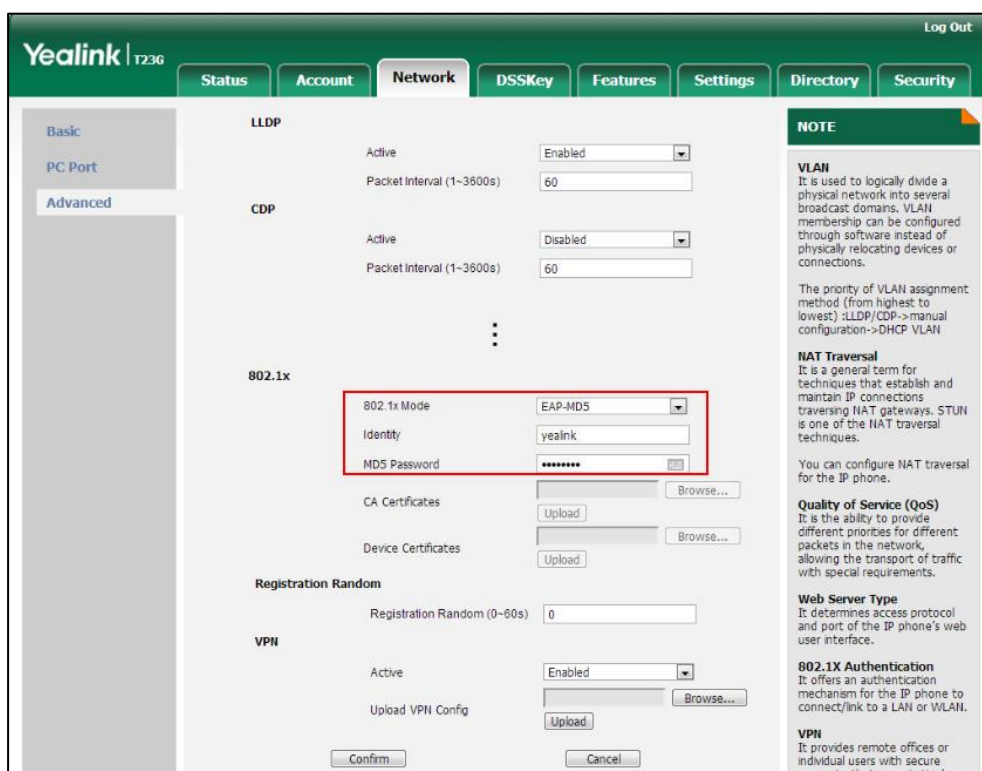

b) If you select **EAP-TLS**:

- 1) Enter the user name for authentication in the **Identity** field.
- 2) Leave the **MD5 Password** field blank.
- 3) In the **CA Certificates** field, click **Browse** to select the desired CA certificate (*.pem, *.crt, *.cer or *.der) from your local system.
- 4) In the **Device Certificates** field, click **Browse** to select the desired client (*.pem or *.cer) certificate from your local system.

5) Click **Upload** to upload the certificates.

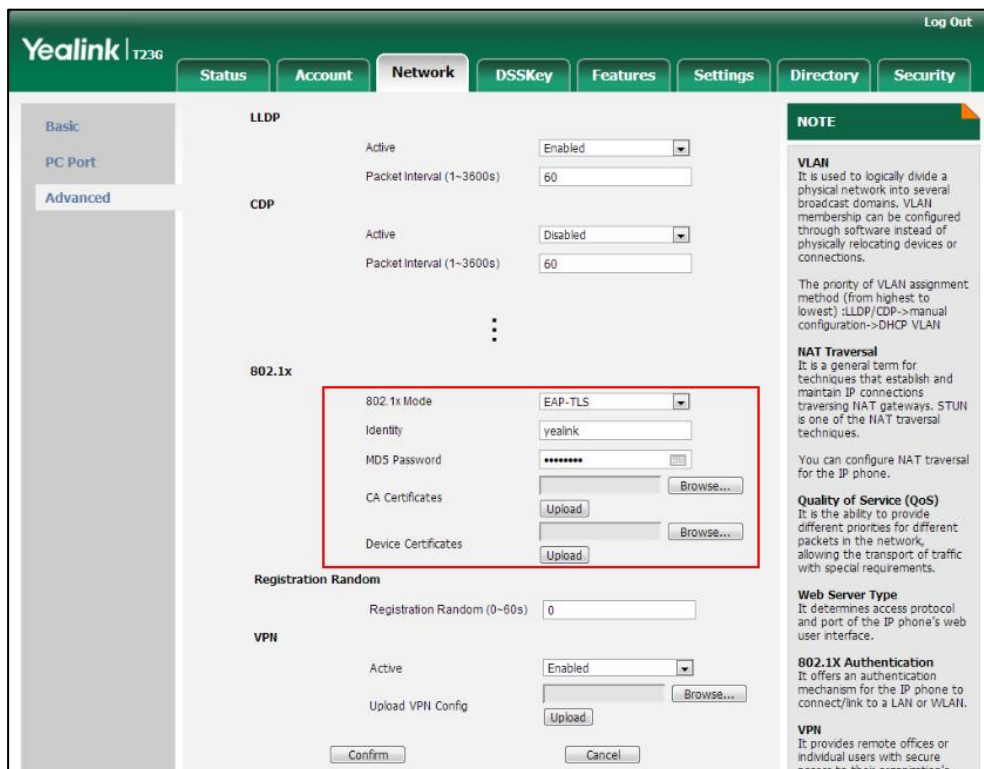

c) If you select **EAP-PEAP/MSCHAPv2**:

- 1) Enter the user name for authentication in the **Identity** field.
- 2) Enter the password for authentication in the **MD5 Password** field.
- 3) In the **CA Certificates** field, click **Browse** to select the desired CA certificate (*.pem, *.crt, *.cer or *.der) from your local system.

4) Click **Upload** to upload the certificate.

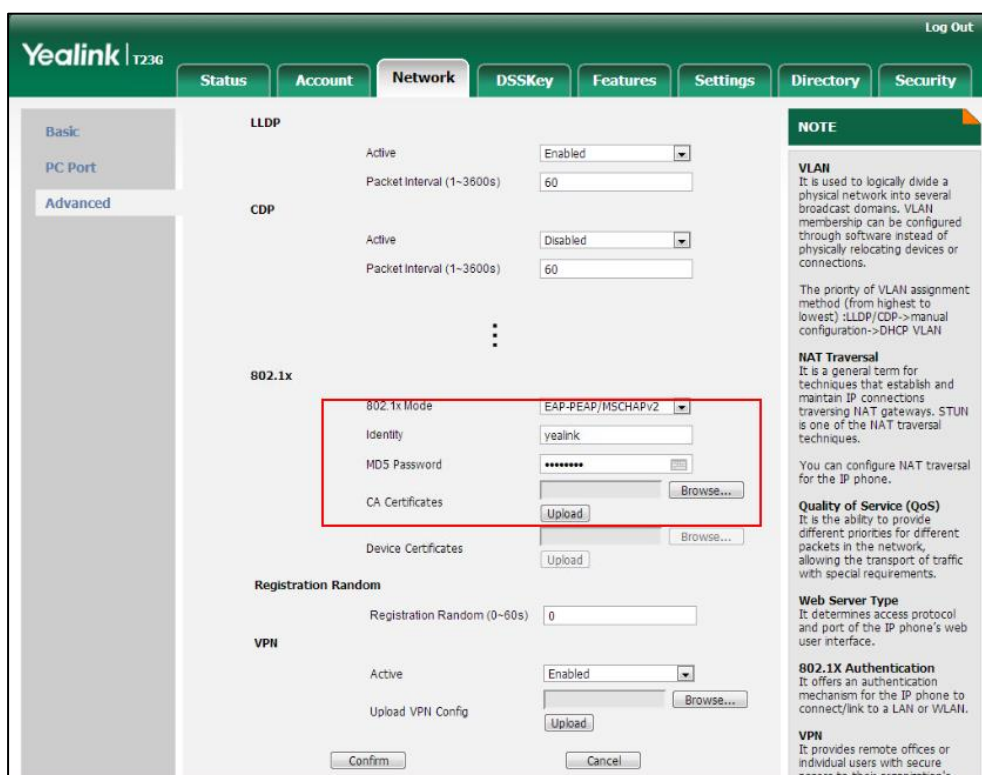

d) If you select **EAP-TTLS/EAP-MSCHAPv2**:

- 1) Enter the user name for authentication in the **Identity** field.
- 2) Enter the password for authentication in the **MD5 Password** field.
- 3) In the **CA Certificates** field, click **Browse** to select the desired CA certificate (*.pem, *.crt, *.cer or *.der) from your local system.

4) Click **Upload** to upload the certificate.

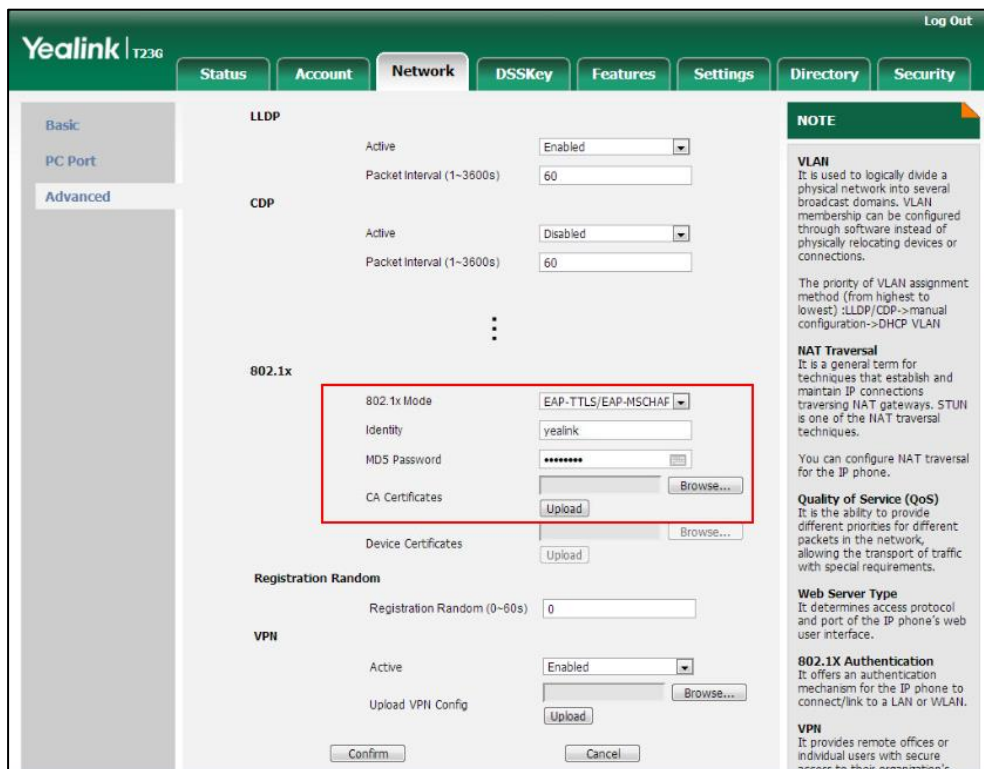

e) If you select **EAP-PEAP/GTC**:

- 1) Enter the user name for authentication in the **Identity** field.
- 2) Enter the password for authentication in the **MD5 Password** field.

- 3) In the **CA Certificates** field, click **Browse** to select the desired CA certificate (*.pem, *.crt, *.cer or *.der) from your local system.

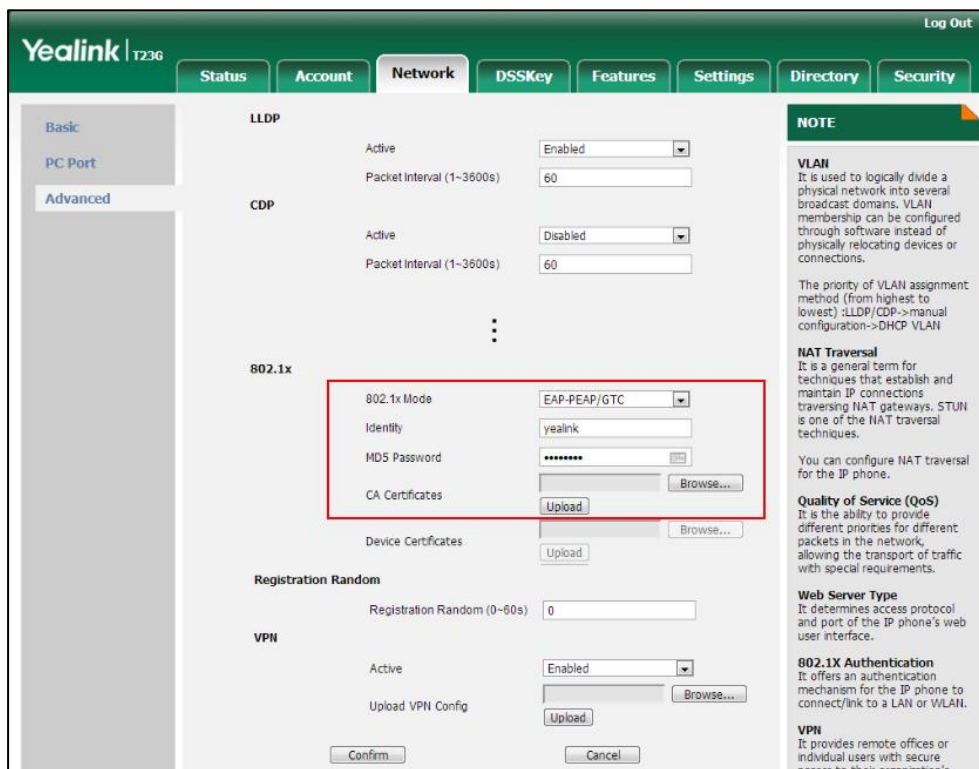

- 4) Click **Upload** to upload the certificate.
- f) If you select **EAP-TTLS/EAP-GTC**:
- 1) Enter the user name for authentication in the **Identity** field.
 - 2) Enter the password for authentication in the **MD5 Password** field.

- 3) In the **CA Certificates** field, click **Browse** to select the desired CA certificate (*.pem, *.crt, *.cer or *.der) from your local system.

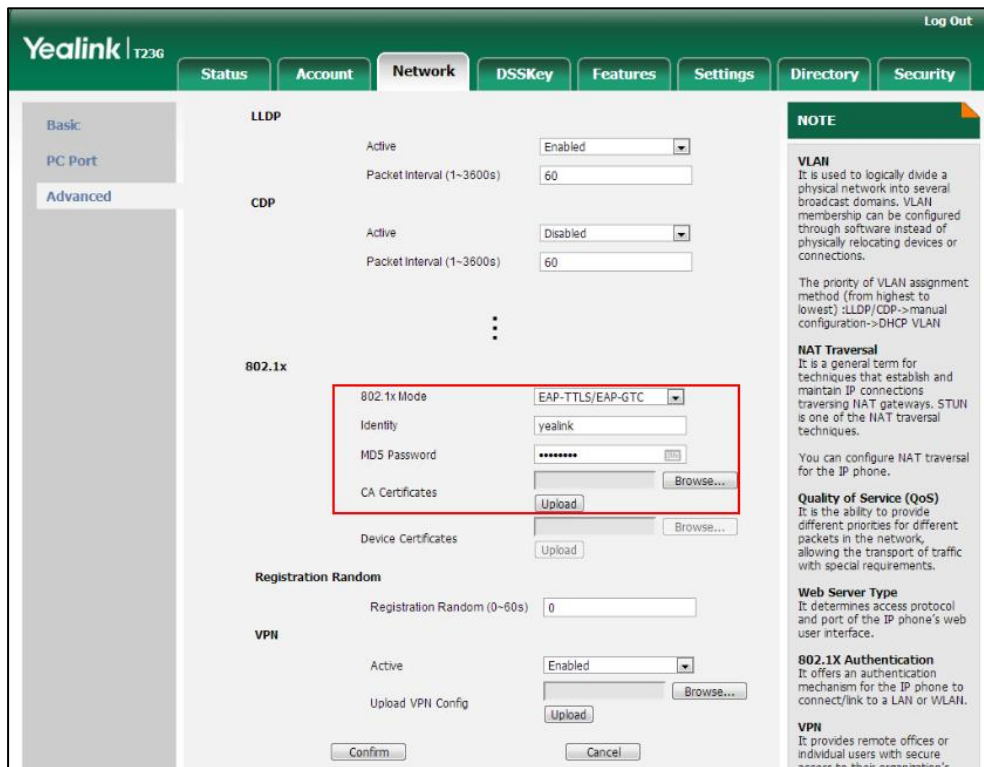

- 4) Click **Upload** to upload the certificate.

g) If you select **EAP-FAST**:

- 1) Enter the user name for authentication in the **Identity** field.
- 2) Enter the password for authentication in the **MD5 Password** field.

- 3) In the **CA Certificates** field, click **Browse** to select the desired CA certificate (*.pem, *.crt, *.cer or *.der) from your local system.

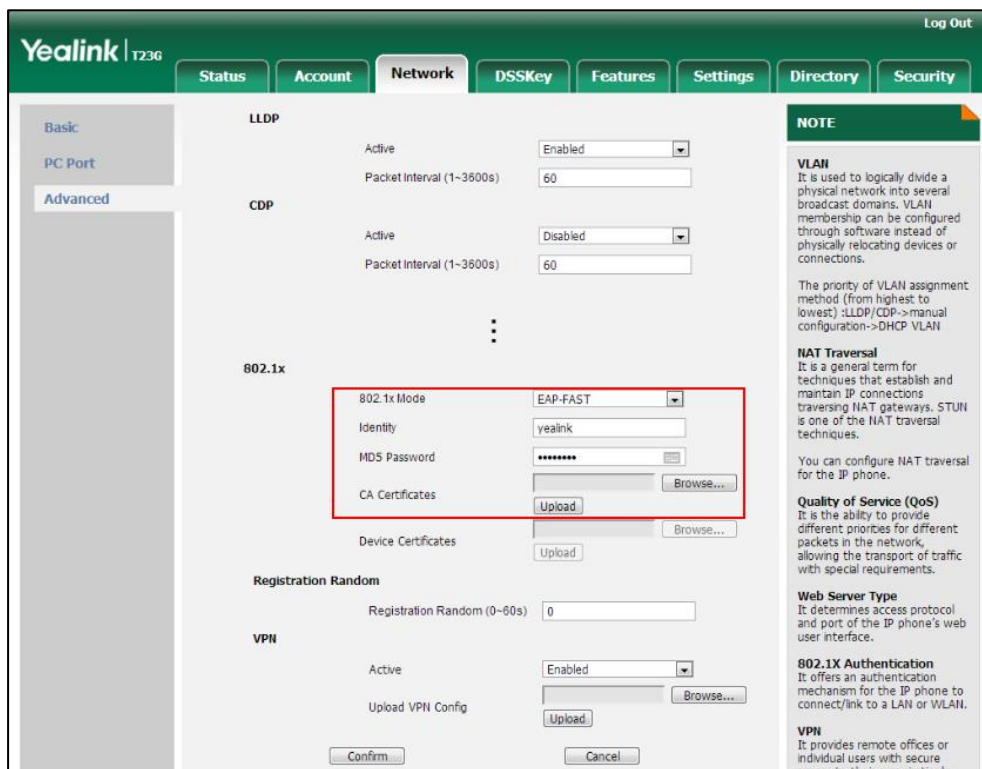

- 4) Click **Upload** to upload the certificate.

3. Click **Confirm** to accept the change.

A dialog box pops up to prompt that settings will take effect after a reboot.

4. Click **OK** to reboot the phone.

To configure the 802.1X authentication via phone user interface after:

1. Press **Menu->Settings->Advanced Settings (default password: admin) ->Network->802.1x Settings**.
2. Press **◀** or **▶**, or the **Switch** soft key to select the desired value from the **802.1x Mode** field.
 - a) If you select **EAP-MD5**:
 - 1) Enter the user name for authentication in the **Identity** field.
 - 2) Enter the password for authentication in the **MD5 Password** field.
 - b) If you select **EAP-TLS**:
 - 1) Enter the user name for authentication in the **Identity** field.
 - 2) Leave the **MD5 Password** field blank.
 - c) If you select **EAP-PEAP/MSCHAPv2**:
 - 1) Enter the user name for authentication in the **Identity** field.
 - 2) Enter the password for authentication in the **MD5 Password** field.
 - d) If you select **EAP-TTLS/EAP-MSCHAPv2**:

- 1) Enter the user name for authentication in the **Identity** field.
 - 2) Enter the password for authentication in the **MD5 Password** field.
 - e) If you select **EAP-PEAP/GTC**:
 - 1) Enter the user name for authentication in the **Identity** field.
 - 2) Enter the password for authentication in the **MD5 Password** field.
 - f) If you select **EAP-TTLS/EAP-GTC**:
 - 1) Enter the user name for authentication in the **Identity** field.
 - 2) Enter the password for authentication in the **MD5 Password** field.
 - g) If you select **EAP-FAST**:
 - 1) Enter the user name for authentication in the **Identity** field.
 - 2) Enter the password for authentication in the **MD5 Password** field.
3. Click **Save** to accept the change.

The IP phone reboots automatically to make the settings effective after a period of time.

Troubleshooting

This chapter provides an administrator with general information for troubleshooting some common problems that he (or she) may encounter while using IP phones.

Troubleshooting Methods

IP phones can provide feedback in a variety of forms such as log files, packets, status indicators and so on, which can help an administrator more easily find the system problem and fix it.

The following are helpful for better understanding and resolving the working status of the IP phone.

- [Viewing Log Files](#)
- [Capturing Packets](#)
- [Enabling Watch Dog Feature](#)
- [Getting Information from Status Indicators](#)
- [Analyzing Configuration File](#)

Viewing Log Files

If your IP phone encounters some problems, commonly the log files are needed. You can configure the phone to periodically upload the log files to the provisioning server (only support an FTP/TFTP as the provisioning server). There are two types of log files on the provisioning server: <mac>-boot.log (e.g., 001565786fed-boot.log) and <mac>-sys.log (001565786fed-sys.log). The <mac>-boot.log file is uploaded to the provisioning server after every boot. The <mac>-sys.log file is uploaded periodically to the provisioning server. You can export the log files to a syslog server or the local system. You can also specify the severity level of the log to be reported to a log file. The default system log level is 3.

In the configuration files, you can use the following parameters to configure system log settings:

- **syslog.mode** – Specify the system log to be exported to the provisioning server, syslog server or local system.
- **syslog.server** -- Specify the IP address or domain name of the syslog server to which the log will be exported.
- **syslog.log_upload_period** - Specify the period of the log upload (in seconds) to the provisioning server.

- **syslog.ftp.post_mode** - Specify whether the log files on the provisioning server are overwritten or appended.
- **syslog.ftp.max_logfile** - Specify the maximum size of the log files on the provisioning server.
- **syslog.ftp.append_limit_mode** - Specify the phone to stop log upload or delete the old lod when the log on the provisioning server reaches the max size.
- **syslog.bootlog_upload_wait_time** - Specify the waiting time before the phone uploads the log file to the provisioning server.
- **syslog.log_level** -- Specify the system log level. The following lists the log level of events you can log:
 - 0: system is unusable
 - 1: action must be taken immediately
 - 2: critical condition
 - 3: error conditions
 - 4: warning conditions
 - 5: normal but significant condition
 - 6: informational

Procedure

Log setting can be configured using the configuration files or locally.

Configuration File	<y0000000000xx>.cfg	<p>Configure the syslog mode.</p> <p>Parameters:</p> <p>syslog.mode</p> <p>Configure the IP address or domain name of the syslog server where to export the log files.</p> <p>Parameters:</p> <p>syslog.server</p> <p>Configure the period of the log upload (in seconds) to the provisioning server.</p> <p>Parameters:</p> <p>syslog.log_upload_period</p> <p>Configure whether the log files on the provisioning server are overwritten or appended.</p> <p>Parameters:</p> <p>syslog.ftp.post_mode</p>
---------------------------	---------------------	--

		<p>Configure the maximum size of the log files on the provisioning server.</p> <p>Parameters:</p> <p>syslog.ftp.max_logfile</p> <p>Configure the phone to stop log upload or delete the old log when the log on the provisioning server reaches the max size.</p> <p>Parameters:</p> <p>syslog.ftp.append_limit_mode</p> <p>Configure the waiting time before the phone uploads the log file to the provisioning server.</p> <p>Parameters:</p> <p>syslog.bootlog_upload_wait_time</p> <p>Configure the severity level of the logs to be reported to a log file.</p> <p>Parameters:</p> <p>syslog.log_level</p>
<p>Local</p>	<p>Web User Interface</p>	<p>Configure the syslog mode.</p> <p>Configure the IP address or domain name of the syslog server where to export the log files.</p> <p>Configure the period of the log upload (in seconds) to the provisioning server.</p> <p>Configure whether the log files on the provisioning server are overwritten or appended.</p> <p>Configure the maximum size of the log files on the provisioning server.</p> <p>Configure the phone to stop log upload or delete the old log when the log on the provisioning server reaches the max size.</p> <p>Configure the waiting time before the phone uploads the log file to the provisioning server.</p> <p>Configure the severity level of the logs to be reported to a log file.</p>

		<p>Navigate to: <a href="http://<phoneIPAddress>/servlet?parameters=settings-config&q=load">http://<phoneIPAddress>/servlet?parameters=settings-config&q=load</p>
--	--	---

Details of Configuration Parameters:

Parameters	Permitted Values	Default
syslog.mode	0, 1 or 2	0
<p>Description: Configures the IP phone to export log files to the local system, syslog server or an FTP/TFTP Server (provisioning server). 0-Local 1-Server 2-FTP/TFTP Server Note: If you change this parameter, the IP phone will reboot to make the change take effect. Web User Interface: Settings->Configuration->Export System Log Phone User Interface: None</p>		
syslog.server	IP address or domain name	Blank
<p>Description: Configures the IP address or domain name of the syslog server when exporting log to the syslog server. Example: syslog.server = 192.168.1.50 Note: It works only if the value of the parameter "syslog.mode" is set to 1 (Server). If you change this parameter, the IP phone will reboot to make the change take effect. Web User Interface: Settings->Configuration->Server Name Phone User Interface: None</p>		
syslog.log_upload_period	Integer from 30 to 2592000	30

Parameters	Permitted Values	Default
<p>Description: Configures the period of the log upload (in seconds) to the provisioning server.</p> <p>Example: syslog.log_upload_period = 60</p> <p>Note: It works only if the value of the parameter "syslog.mode" is set to 2 (FTP/TFTP Server). If you change this parameter, the IP phone will reboot to make the change take effect.</p> <p>Web User Interface: Settings->Configuration->Upload Period(30~2592000)s</p> <p>Phone User Interface: None</p>		
syslog.ftp.post_mode	1 or 2	1
<p>Description: Configures whether the log files on the provisioning server are overwritten or appended.</p> <p>1-Post Append 2-Post Stor (not applicable to TFTP Server)</p> <p>If it is set to 1 (Post Append), the log files on the provisioning server are appended. If it is set to 2 (Post Stor), the log files on the provisioning server are overwritten.</p> <p>Note: It works only if the value of the parameter "syslog.mode" is set to 2 (FTP/TFTP Server). If you change this parameter, the IP phone will reboot to make the change take effect.</p> <p>Web User Interface: Settings->Configuration->Post Mode</p> <p>Phone User Interface: None</p>		
syslog.ftp.max_logfile	Integer from 200 to 65535	512
<p>Description: Configures the maximum size of the log files on the provisioning server.</p> <p>Example: syslog.ftp.max_logfile = 511</p> <p>Note: It works only if the value of the parameter "syslog.mode" is set to 2 (FTP/TFTP</p>		

Parameters	Permitted Values	Default
<p>Server). If you change this parameter, the IP phone will reboot to make the change take effect.</p> <p>Web User Interface: Settings->Configuration->Append Limit Size(200~65535)K</p> <p>Phone User Interface: None</p>		
syslog.ftp.append_limit_mode	1 or 2	1
<p>Description: Configures the phone to stop upload log or delete the old log when the log on the provisioning server reaches the max size.</p> <p>1-Append Delete 2-Append Stop</p> <p>Note: It works only if the value of the parameter "syslog.mode" is set to 2 (FTP/TFTP Server). If you change this parameter, the IP phone will reboot to make the change take effect.</p> <p>Web User Interface: Settings->Configuration->Append Limit Mode</p> <p>Phone User Interface: None</p>		
syslog.bootlog_upload_wait_time	Integer from 1 to 86400	120
<p>Description: Configures the waiting time (in seconds) before the phone uploads the log file to the provisioning server.</p> <p>Example: syslog.bootlog_upload_wait_time = 121</p> <p>Note: It works only if the value of the parameter "syslog.mode" is set to 2 (FTP/TFTP Server). If you change this parameter, the IP phone will reboot to make the change take effect.</p> <p>Web User Interface: None</p> <p>Phone User Interface: None</p>		

Parameters	Permitted Values	Default
syslog.log_level	Integer from 0 to 6	3
<p>Description: Configures the detail level of syslog information to be exported. 0-system is unusable 1-action must be taken immediately 2-critical condition 3-error conditions 4-warning conditions 5-normal but significant condition 6-informational</p> <p>Note: If you change this parameter, the IP phone will reboot to make the change take effect.</p> <p>Web User Interface: Settings->Configuration->System Log Level</p> <p>Phone User Interface: None</p>		

To configure the level of the system log via web user interface:

1. Click on **Settings->Configuration**.
2. Select the desired level from the pull-down list of **System Log Level**.

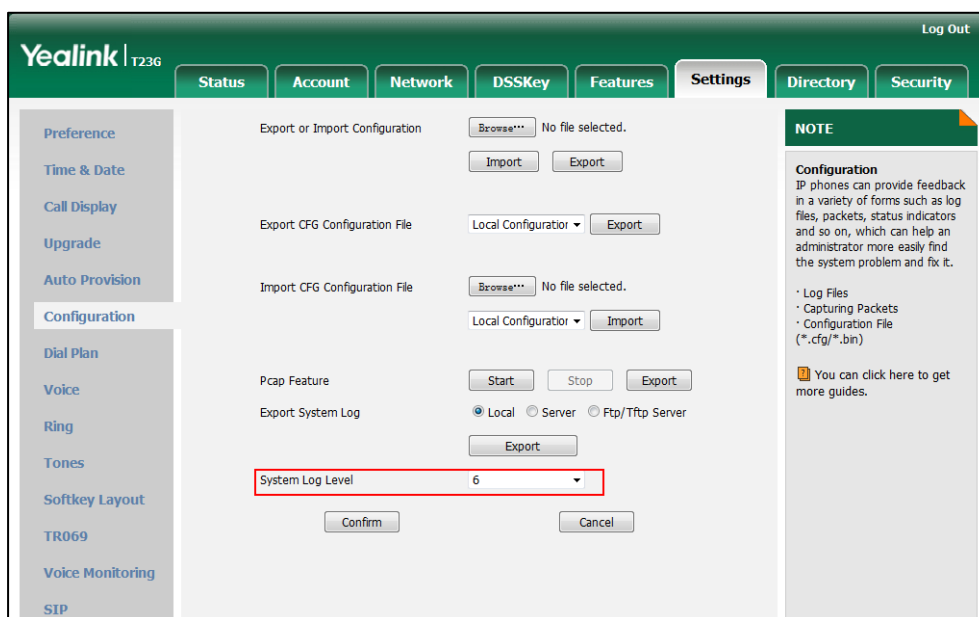

3. Click **Confirm** to accept the change.

The system log level is set as 6, the informational level.

Note Informational level may make some sensitive information accessible (e.g., password dial number), we recommend that you reset the system log level to 3 after providing the syslog file.

To configure the phone to export the system log to a syslog server via web user interface:

1. Click on **Settings->Configuration**.
2. Mark the **Server** radio box in the **Export System Log** field.
3. Enter the IP address or domain name of the syslog server in the **Server Name** field.

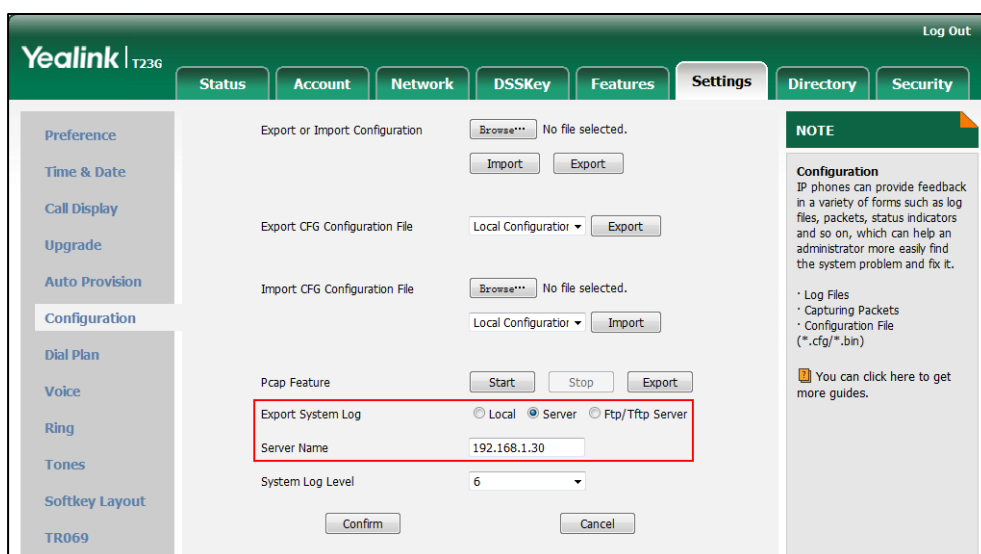

4. Click **Confirm** to accept the change.
A dialog box pops up to prompt "Do you want to restart your machine?". The configuration will take effect after a reboot.
5. Click **OK** to reboot the phone.
The system log will be exported successfully to the desired syslog server after a reboot.
6. Reproduce the issue.

To export a log file to the local system via web user interface:

1. Click on **Settings->Configuration**.
2. Mark the **Local** radio box in the **Export System Log** field.
3. Reproduce the issue.

- Click **Export** to open file download window, and then save the file to your local system.

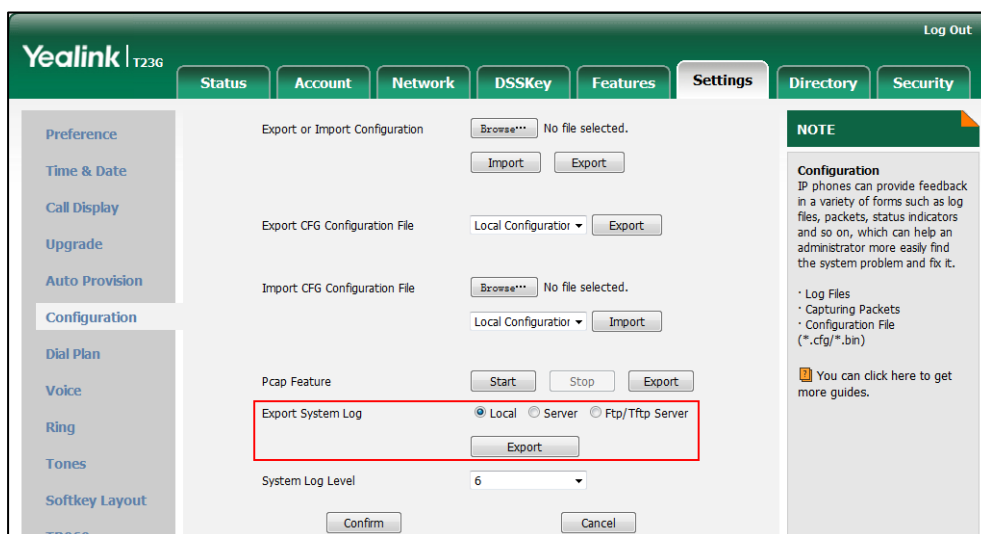

The following figure shows a portion of a log file- an account registration:

```

Nov 17 06:15:18 sua [497]: DLG <6+info > [000]
Nov 17 06:15:18 sua [497]: DLG <6+info > [000] REGISTER sip:10.3.5.199:5060 SIP/2.0^M
Nov 17 06:15:18 sua [497]: DLG <6+info > [000] Via: SIP/2.0/UDP 10.3.20.1:5060;branch=z9hG4bK3586181787^M
Nov 17 06:15:18 sua [497]: DLG <6+info > [000] From: "1006" <sip:1006@10.3.5.199:5060>;tag=788357634^M
Nov 17 06:15:18 sua [497]: DLG <6+info > [000] To: "1006" <sip:1006@10.3.5.199:5060>^M
Nov 17 06:15:18 sua [497]: DLG <6+info > [000] Call-ID: 0_2241231544@10.3.20.1^M
Nov 17 06:15:18 sua [497]: DLG <6+info > [000] CSeq: 59 REGISTER^M
Nov 17 06:15:18 sua [497]: DLG <6+info > [000] Contact: <sip:1006@10.3.20.1:5060;line=d0bf0feaff1c2e5>^M
Nov 17 06:15:18 sua [497]: DLG <6+info > [000] Allow: INVITE, INFO, PRACK, ACK, BYE, CANCEL, OPTIONS, NOTIFY, REGISTER, SUBSCRIBE,
Nov 17 06:15:18 sua [497]: DLG <6+info > [000] Max-Forwards: 70^M
Nov 17 06:15:18 sua [497]: DLG <6+info > [000] User-Agent: Yealink SIP-T46G 28.80.208.60^M
Nov 17 06:15:18 sua [497]: DLG <6+info > [000] Expires: 3600^M
Nov 17 06:15:18 sua [497]: DLG <6+info > [000] Allow-Events: talk,hold,conference,REFER,check-sync^M
Nov 17 06:15:18 sua [497]: DLG <6+info > [000] Content-Length: 0^M
Nov 17 06:15:18 sua [497]: DLG <6+info > [000] ^M
Nov 17 06:15:18 sua [497]: NET <5+notice> [000] =====>> UDP socket 10.3.5.199:5060: send 566 bytes
Nov 17 06:15:18 sua [497]: FSM <6+info > [000] free transaction resource 156 0_2241231544
Nov 17 06:15:18 sua [497]: FSM <6+info > [255] free nict resource
Nov 17 06:15:18 sua [497]: NET <5+notice> [255] <<<==== UDP socket 10.3.5.199:5060: read 321 bytes
Nov 17 06:15:18 sua [497]: SIP <6+info > [SIP] match line:name:1006 host:10.3.5.199
Nov 17 06:15:18 sua [497]: DLG <5+notice> [000] Message rcv: (from src=10.3.5.199:5060 len=321)
Nov 17 06:15:18 sua [497]: DLG <6+info > [000]
Nov 17 06:15:18 sua [497]: DLG <6+info > [000] SIP/2.0 200 OK^M
Nov 17 06:15:18 sua [497]: DLG <6+info > [000] To: "1006" <sip:1006@10.3.5.199:5060>;tag=10580^M
Nov 17 06:15:18 sua [497]: DLG <6+info > [000] From: "1006" <sip:1006@10.3.5.199:5060>;tag=788357634^M
Nov 17 06:15:18 sua [497]: DLG <6+info > [000] Via: SIP/2.0/UDP 10.3.20.1:5060;branch=z9hG4bK3586181787^M
Nov 17 06:15:18 sua [497]: DLG <6+info > [000] CSeq: 59 REGISTER^M
Nov 17 06:15:18 sua [497]: DLG <6+info > [000] Call-ID: 0_2241231544@10.3.20.1^M
Nov 17 06:15:18 sua [497]: DLG <6+info > [000] Contact: <sip:1006@10.3.20.1:5060;line=d0bf0feaff1c2e5>;expires=3600^M
Nov 17 06:15:18 sua [497]: DLG <6+info > [000] Content-Length: 0^M
    
```

To configure the phone to export the system log to an FTP/TFTP server via web user interface:

- Click on **Settings->Configuration**.
- Mark the **Ftp/Tftp server** radio box in the **Export System Log** field.
- Enter the upload period of the log files in the **Upload Period (30~2592000)s** field.
- Select the desired post mode from the pull-down list of **Post Mode**.
- Enter the limit size of the log files in the **Append Limit Size (200~65535)K** field.

7. Select the desired limit mode from the pull-down list of **Append Limit Mode**.

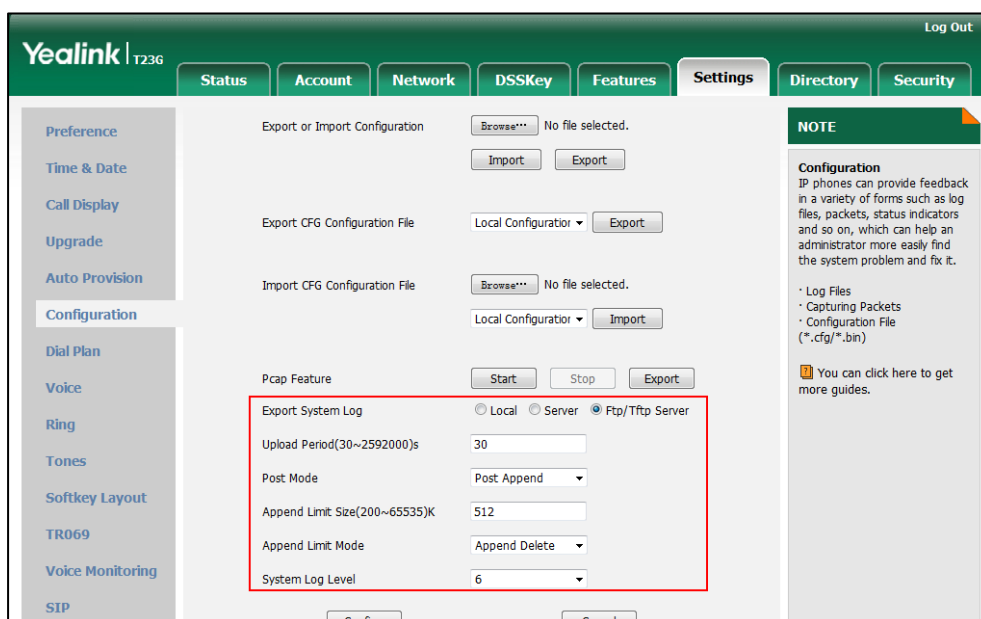

8. Click **Confirm** to accept the change.

A dialog box pops up to prompt "Do you want to restart your machine?". The configuration will take effect after a reboot.

9. Click **OK** to reboot the phone.

The system log will be exported successfully to the desired FTP/TFTP server after a reboot.

10. Reproduce the issue.

The following figure shows a portion of a <mac>-boot.log (e.g., 0015654146dd-boot.log):

```
Nov 17 00:00:04 syslogd started: BusyBox v1.10.3
Nov 17 00:00:05 sys [494]: ANY <+emerg> > sys log :sys=1,cons=1,time=0,E=3,W=4,N=5,I=6,D=7
Nov 17 00:00:05 sys [494]: ANY <+emerg> > ANY =3
Nov 17 00:00:05 sua [494]: APP <+error> > [SIP] APP Name=[sua ] Version=[(Nov 11 2014,17:22:12)]
Nov 17 00:00:09 TR9 [562]: ANY <+emerg> > TR9 log :sys=1,cons=0,time=0,E=3,W=4,N=5,I=6,D=7
Nov 17 00:00:09 TR9 [562]: ANY <+emerg> > ANY =5
Nov 17 00:00:09 TR9 [562]: ANY <+emerg> > ANY =3
Nov 17 00:00:09 sys [562]: ANY <+emerg> > sys log :sys=1,cons=1,time=0,E=3,W=4,N=5,I=6,D=7
Nov 17 00:00:09 sys [562]: ANY <+emerg> > ANY =3
Nov 17 00:00:10 LIBD[374]: DANY<+emerg> > LIBD log :sys=1,cons=0,time=0,E=3,W=4,N=5,I=6,D=7
Nov 17 00:00:10 LIBD[374]: DANY<+emerg> > LIBD log :sys=1,cons=1,time=0,E=3,W=4,N=5,I=6,D=7
Nov 17 00:00:11 LIBD[374]: DANY<+emerg> > DANY=3
Nov 17 00:00:13 sys [589]: ANY <+emerg> > sys log :sys=1,cons=1,time=0,E=3,W=4,N=5,I=6,D=7
Nov 17 00:00:13 sys [589]: ANY <+emerg> > ANY =3
Nov 17 00:00:13 ipp [587]: ANY <+emerg> > 413.370.731:ipp log :type=1,time=1,E=3,W=4,N=5,I=6,D=7
Nov 17 00:00:13 ipp [587]: ANY <+emerg> > 413.377.973:Libipp Version :2.0.0.6 For release
Nov 17 00:00:13 ipp [587]: ANY <+emerg> > 413.378.569:Built-at:Nov 13 2014,04:55:51
Nov 17 00:00:13 ipp [587]: ANY <+emerg> > 413.379.025:Logmode :0x00000003
Nov 17 00:00:13 ipp [587]: ANY <+emerg> > 413.379.644:setting :memcheck=0,assert=0
Nov 17 00:00:13 ipp [587]: ANY <+emerg> > 413.380.090:ANY =6
Nov 17 00:00:13 ipp [587]: IIPP<+info> > 413.380.579:ipp created
Nov 17 00:00:13 ipp [587]: IAUD<+info> > 413.418.894:audio init
Nov 17 00:00:13 ipp [587]: IMIX<+info> > 413.433.422:mixer init
Nov 17 00:00:13 ipp [587]: IMIX<+warnin> > 413.434.437:Disconnect portid ept 0xc311ac20 audio 0xc32d6560 err 0xffffffff
Nov 17 00:00:13 ipp [587]: IMIX<+warnin> > 413.435.125:Disconnect portid audio 0xc32d6560 ept 0xc311ac20 err 0xffffffff
Nov 17 00:00:13 ipp [587]: IMIX<+warnin> > 413.435.641:Disconnect portid ept 0xc311aba0 audio 0xc32d64e0 err 0xffffffff
Nov 17 00:00:13 ipp [587]: IMIX<+warnin> > 413.436.140:Disconnect portid audio 0xc32d64e0 ept 0xc311aba0 err 0xffffffff
Nov 17 00:00:13 ipp [587]: IMIX<+warnin> > 413.436.632:Disconnect portid ept 0xc311aba0 audio 0xc32d64e0 err 0xffffffff
Nov 17 00:00:13 ipp [587]: IMIX<+warnin> > 413.437.118:Disconnect portid audio 0xc32d64e0 ept 0xc311aba0 err 0xffffffff
Nov 17 00:00:13 ipp [587]: IMIX<+warnin> > 413.437.601:Disconnect portid ept 0xc311ab20 audio 0xc32d6460 err 0xffffffff
Nov 17 00:00:13 ipp [587]: IMIX<+warnin> > 413.438.264:Disconnect portid audio 0xc32d6460 ept 0xc311ab20 err 0xffffffff
```

The following figure shows a portion of a <mac>-sys.log (e.g., 0015654146dd-sys.log):

```

Nov 19 09:15:36 sua [500]: DLG <6+info > [000]
Nov 19 09:15:36 sua [500]: DLG <6+info > [000] SIP/2.0 489 Bad Event^M
Nov 19 09:15:36 sua [500]: DLG <6+info > [000] Via: SIP/2.0/UDP 10.3.5.199;branch=z9hG4bkd620ea0c16948288b1beed8f^M
Nov 19 09:15:36 sua [500]: DLG <6+info > [000] Via: SIP/2.0/UDP 10.3.20.6:5060;branch=z9hG4bK2629074510^M
Nov 19 09:15:36 sua [500]: DLG <6+info > [000] From: "1001" <sip:1001@10.3.5.199:5060>;tag=388068281^M
Nov 19 09:15:36 sua [500]: DLG <6+info > [000] To: "1001" <sip:1001@10.3.5.199:5060>;tag=3065180689^M
Nov 19 09:15:36 sua [500]: DLG <6+info > [000] Call-ID: 0_391406989@10.3.20.6^M
Nov 19 09:15:36 sua [500]: DLG <6+info > [000] CSeq: 1 SUBSCRIBE^M
Nov 19 09:15:36 sua [500]: DLG <6+info > [000] Event: as-feature-event^M
Nov 19 09:15:36 sua [500]: DLG <6+info > [000] User-Agent: Yealink SIP-T46G 28.80.208.61^M
Nov 19 09:15:36 sua [500]: DLG <6+info > [000] Content-Length: 0^M
Nov 19 09:15:36 sua [500]: DLG <6+info > [000] ^M
Nov 19 09:15:36 sua [500]: DLG <6+info > [000]
Nov 19 09:15:36 sua [500]: NET <5+notice> [000] ==>>> UDP socket 10.3.5.199:5060: send 400 bytes
Nov 19 09:15:36 sua [500]: NET <5+notice> [255] <<<=== UDP socket 10.3.5.199:5060: read 660 bytes
Nov 19 09:15:36 sua [500]: DLG <5+notice> [000] Message rcv: (from src=10.3.5.199:5060 len=660)
Nov 19 09:15:36 sua [500]: DLG <6+info > [000]
Nov 19 09:15:36 sua [500]: DLG <6+info > [000] SUBSCRIBE sip:1001@10.3.20.1:5060;line=cb84c640bef6858 SIP/2.0^M
Nov 19 09:15:36 sua [500]: DLG <6+info > [000] Via: SIP/2.0/UDP 10.3.5.199;branch=z9hG4bk389289b04d8f7f1294743e0c7, SIP/2.0/UDP 10.
Nov 19 09:15:36 sua [500]: DLG <6+info > [000] From: "1001" <sip:1001@10.3.5.199:5060>;tag=1684197574^M
Nov 19 09:15:36 sua [500]: DLG <6+info > [000] To: "1001" <sip:1001@10.3.5.199:5060>^M
Nov 19 09:15:36 sua [500]: DLG <6+info > [000] Call-ID: 0_992240714@10.3.20.6^M
Nov 19 09:15:36 sua [500]: DLG <6+info > [000] CSeq: 1 SUBSCRIBE^M
Nov 19 09:15:36 sua [500]: DLG <6+info > [000] Contact: <sip:1001@10.3.20.6:5060>^M
Nov 19 09:15:36 sua [500]: DLG <6+info > [000] Allow: INVITE, INFO, PRACK, ACK, BYE, CANCEL, OPTIONS, NOTIFY, REGISTER, SUBSCRIBE,
Nov 19 09:15:36 sua [500]: DLG <6+info > [000] Accept: application/x-broadworks-callpark-info+xml^M
Nov 19 09:15:36 sua [500]: DLG <6+info > [000] Max-Forwards: 69^M
Nov 19 09:15:36 sua [500]: DLG <6+info > [000] User-Agent: Yealink SIP-T23 44.80.0.5^M
Nov 19 09:15:36 sua [500]: DLG <6+info > [000] Expires: 3600^M
Nov 19 09:15:36 sua [500]: DLG <6+info > [000] Event: x-broadworks-callpark^M
Nov 19 09:15:36 sua [500]: DLG <6+info > [000] Content-Length: 0^M

```

Capturing Packets

You can capture packet in two ways: capturing the packets via web user interface or using the Ethernet software. You can analyze the packet captured for troubleshooting purpose.

Capturing the Packets via Web User Interface

To capture packets via web user interface:

1. Click on **Settings->Configuration**.
2. Click **Start** to start capturing signal traffic.
3. Reproduce the issue to get stack traces.
4. Click **Stop** to stop capturing.

- Click **Export** to open the file download window, and then save the file to your local system.

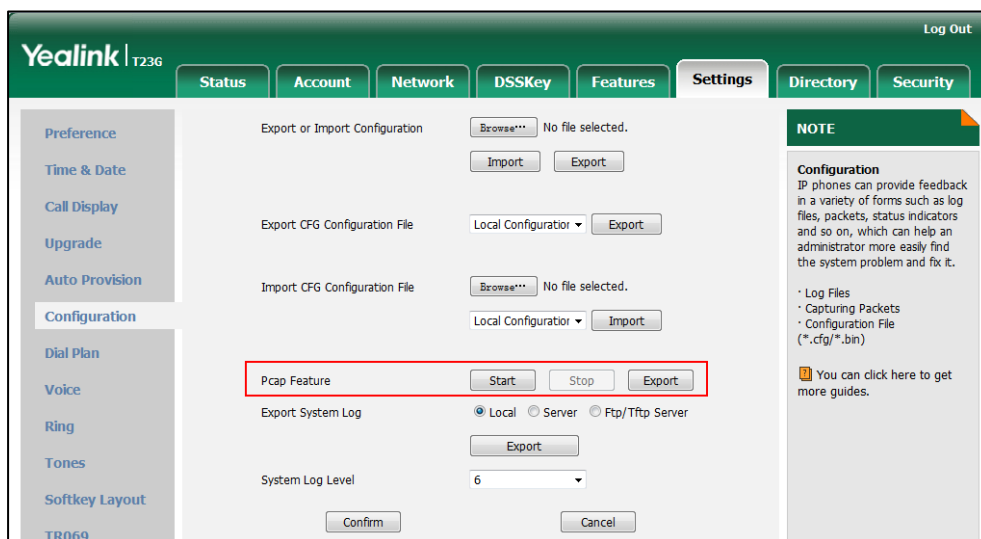

Capturing the Packets Using the Ethernet Software

Receiving data packets from the HUB

Connect the Internet port of the IP phone and the PC to the same HUB, and then use Sniffer, Ethereal or Wireshark software to capture the signal traffic.

Receiving data packets from PC port

Connect the Internet port of the IP phone to the Internet and the PC port of the IP phone to a PC. Before capturing the signal traffic, make sure the data packets can be received from the WAN (Internet) port to the PC (LAN) port.

Procedure

Span to PC port can be configured using the configuration files or locally.

Configuration File	<y0000000000xx>.cfg	Configure span to PC Port. Parameter: network.span_to_pc_port
Local	Web User Interface	Configure span to PC Port. Navigate to: http://<phoneIPAddress/servlet?p=network-adv&q=load

Details of the Configuration Parameter:

Parameter	Permitted Values	Default
network.span_to_pc_port	0 or 1	0
<p>Description: Enables or disables the IP phone to span data packets received from the WAN (Internet) port to the PC (LAN) port.</p> <p>0-Disabled 1-Enabled</p> <p>If it is set to 1 (Enabled), all data packets from WAN port can be received by PC port.</p> <p>Note: If you change this parameter, the IP phone will reboot to make the change take effect.</p> <p>Web User Interface: Network->Advanced->Span to PC->Span to PC Port</p> <p>Phone User Interface: None</p>		

To enable span to pc port via web user interface:

1. Click on **Network->Advanced**.

2. Select **Enabled** from the pull-down list of **Span to PC Port**.

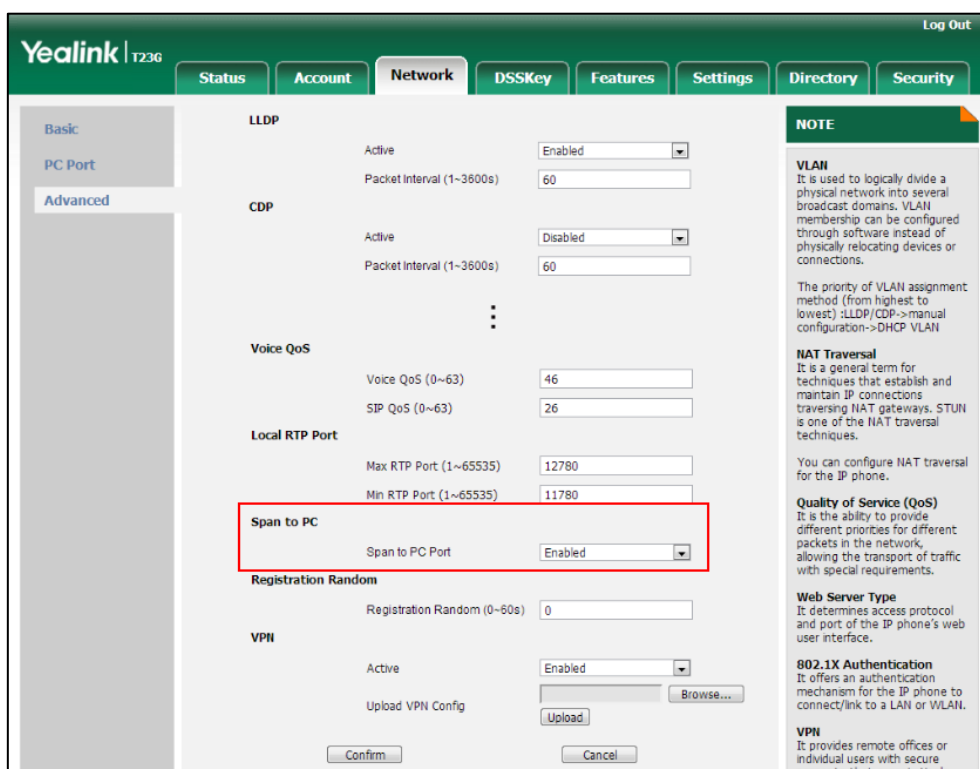

5. Click **Confirm** to accept the change.

A dialog box pops up to prompt that settings will take effect after a reboot.

6. Click **OK** to reboot the phone.

Then you can use Sniffer, Ethereal or Wireshark software to capture the signal traffic.

Enabling Watch Dog Feature

The IP phone provides a troubleshooting feature called “Watch Dog”, which helps you monitor the IP phone status and provides the ability to get stack traces from the last time the IP phone failed. If Watch Dog feature is enabled, the IP phone will automatically reboot when it detects a fatal failure. This feature can be configured using the configuration files or via web user interface.

Procedure

Watch Dog can be configured using the configuration files or locally.

Configuration File	<y0000000000xx>.cfg	Configure Watch Dog feature. Parameter: watch_dog.enable
Local	Web User Interface	Configure Watch Dog

		feature. Navigate to: http://<phoneIPAddress>/servlet?p=settings-preference&q=load
--	--	---

Details of the Configuration Parameter:

Parameter	Permitted Values	Default
watch_dog.enable	0 or 1	1
<p>Description: Enables or disables the Watch Dog feature. 0-Disabled 1-Enabled If it is set to 1 (Enabled), the IP phone will reboot automatically when the system is broken down.</p> <p>Web User Interface: Settings->Preference->WatchDog</p> <p>Phone User Interface: None</p>		

To configure watch dog feature via web user interface:

1. Click on **Settings->Preference**.
2. Select the desired value from the pull-down list of **WatchDog**.

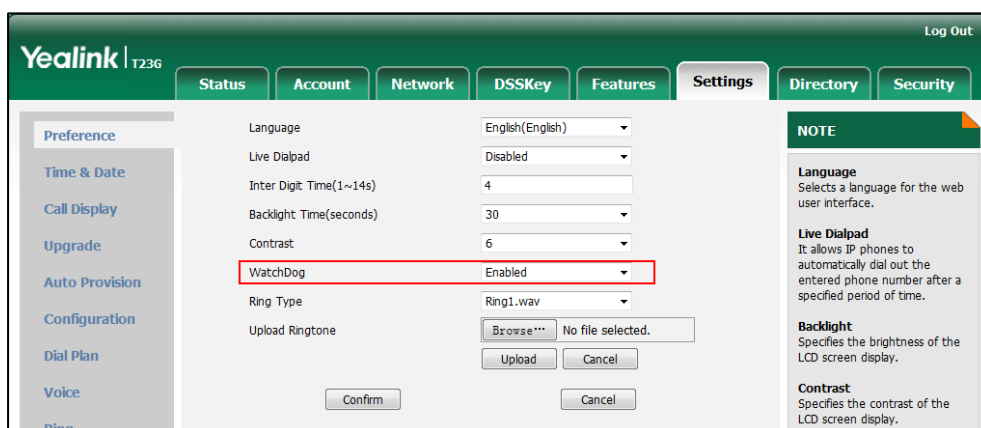

3. Click **Confirm** to accept the change.

Getting Information from Status Indicators

Status indicators may consist of the power LED, MESSAGE key LED, line key indicator, headset key indicator and the on-screen icon.

The following shows two examples of obtaining the IP phone information from status indicators on SIP-T23G IP phones:

- If a LINK failure of the IP phone is detected, a prompting message "Network unavailable" and the icon  will appear on the LCD screen.
- If a voice mail is received, the MESSAGE key LED illuminates.

For more information on the icons, refer to [Reading Icons](#) on page 28.

Analyzing Configuration File

Wrong configurations may have an impact on your phone use. You can export configuration file to check the current configuration of the IP phone and troubleshoot if necessary. You can also import configuration files for a quick and easy configuration.

Three types of configuration files can be exported to your local system:

- config.bin
- <mac>-all.cfg
- <mac>-local.cfg

We recommend you to edit the exported CFG file instead of the BIN file to change the phone's current settings if your phone is running firmware version 73 or later. For more information on configuration files, refer to [Configuration Files](#) on page 38.

BIN Configuration Files

The config.bin file is an encrypted file. For more information on config.bin file, contact your Yealink reseller.

Procedure

Configuration changes can be performed using the configuration files or locally.

Configuration File	<y0000000000xx>.cfg	Specify the access URL for the custom configuration files. Parameter: configuration.url
Local	Web User Interface	Export or import the custom configuration files. Navigate to:

		http://<phoneIPAddress>/servlet ?p=settings-config&q=load
--	--	--

Details of the Configuration Parameter:

Parameter	Permitted Values	Default
configuration.url	URL within 511 characters	Blank

Description:
Configures the access URL for the custom configuration files.

Note: The file format of custom configuration file must be *.bin.

Web User Interface:
Settings->Configuration->Export or Import Configuration

Phone User Interface:
None

To export BIN configuration files via web user interface:

1. Click on **Settings->Configuration**.
2. In the **Export or Import Configuration** block, click **Export** to open the file download window, and then save the file to your local system.

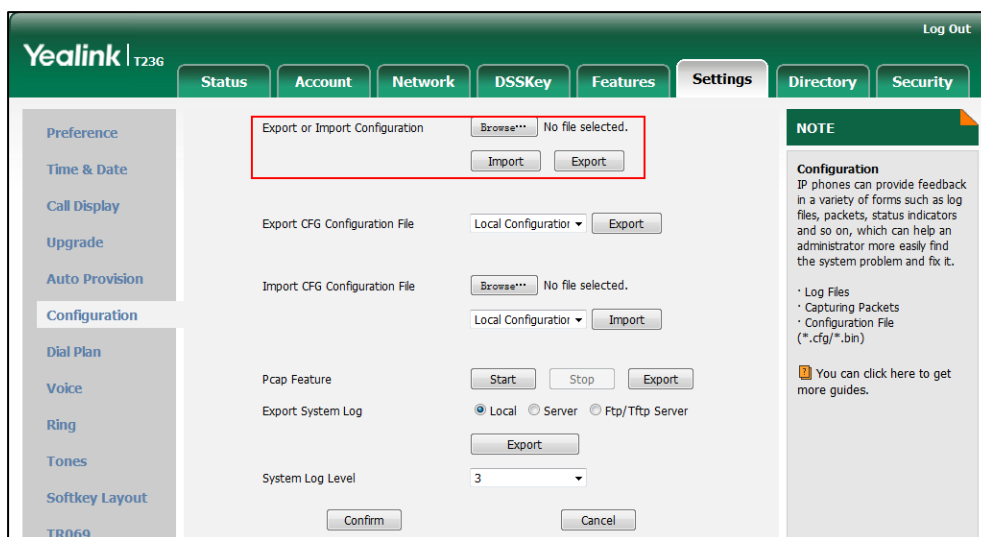

To import a BIN configuration file via web user interface:

1. Click on **Settings->Configuration**.

2. In the **Export or Import Configuration** block, click **Browse** to locate a BIN configuration file from your local system.

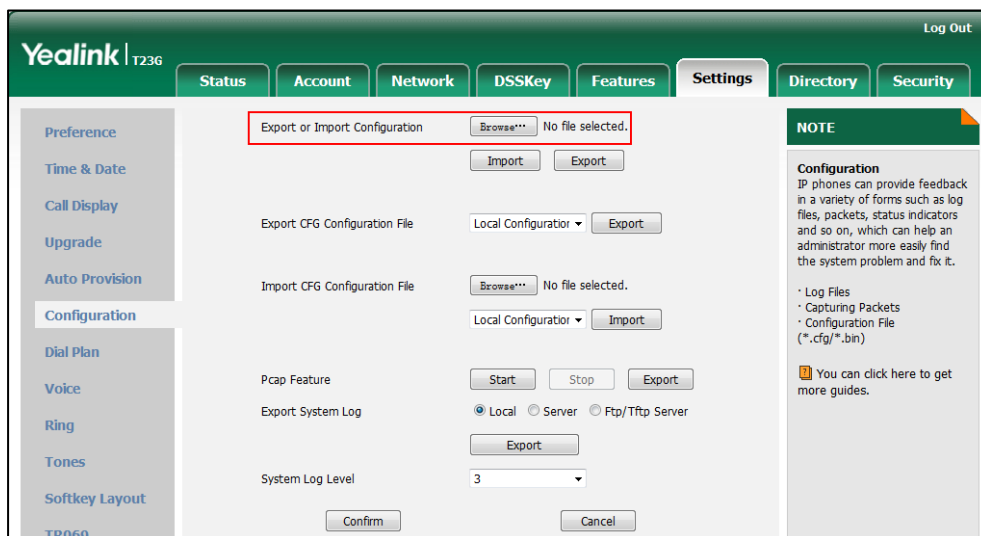

3. Click **Import** to import the configuration file.

CFG Configuration Files

The <mac>-all.cfg configuration file contains all changes made via phone user interface, web user interface and using configuration files. The <mac>-local.cfg configuration file contains changes made via phone user interface and web user interface.

To export CFG configuration files via web user interface:

1. Click on **Settings->Configuration**.
2. Select **Local Configuration** or **All Configuration** from the pull-down list of **Export CFG Configuration File**.

3. Click **Export** to open file download window, and then save the file to your local system.

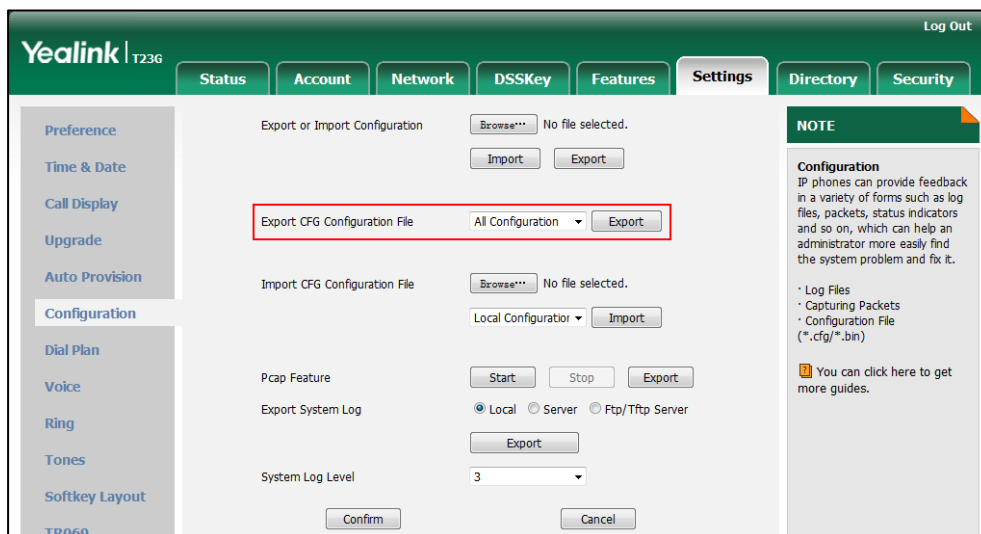

To import CFG configuration files via web user interface:

1. Click on **Settings->Configuration**.
2. In the **Import CFG Configuration File** block, click **Browse** to locate a CFG configuration file from your local system.

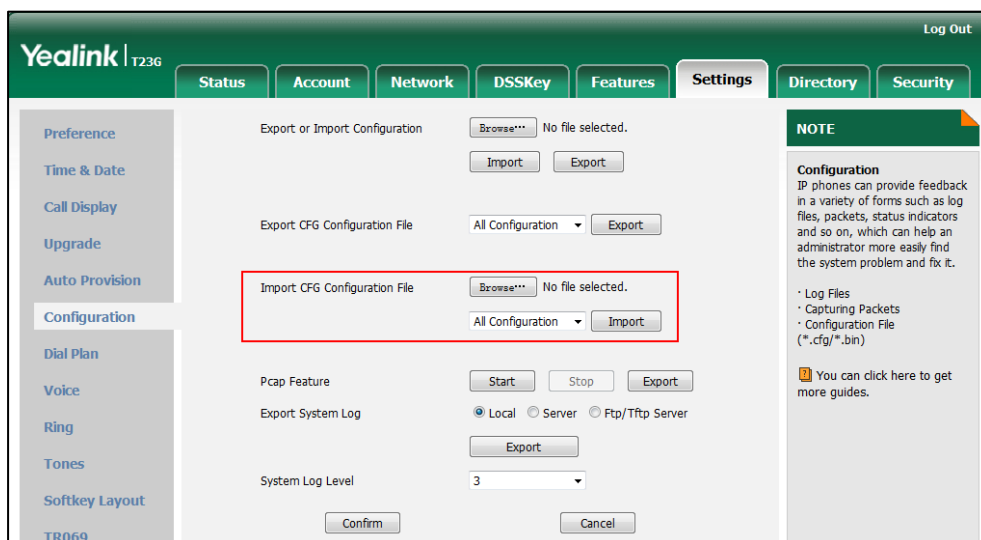

3. Click **Import** to import the configuration file.

Troubleshooting Solutions

This section describes solutions to common issues that may occur while using the IP phone. Upon encountering a scenario not listed in this section, contact your Yealink reseller for further support.

Why is the LCD screen blank?

Do one of the following:

- Ensure that the IP phone is properly plugged into a functional AC outlet.
- Ensure that the IP phone is plugged into a socket controlled by a switch that is on.
- If the IP phone is plugged into a power strip, try plugging it directly into a wall outlet.
- If your phone is PoE powered, ensure that you are using a PoE-compliant switch or hub.

Why doesn't the IP phone get an IP address?

Do one of the following:

- Ensure that the Ethernet cable is plugged into the Internet port on the IP phone and the Ethernet cable is not loose.
- Ensure that the Ethernet cable is not damaged.
- Ensure that the IP address and related network parameters are set correctly.
- Ensure that your network switch or hub is operational.

Why does the IP phone display "No Service"?

The LCD screen prompts "No Service" message when there is no available SIP account on the IP phone.

Do one of the following:

- Ensure that an account is actively registered on the IP phone at the path **Menu->Status->More->Accounts**.
- Ensure that the SIP account parameters have been configured correctly.

How do I find the basic information of the IP phone?

Press the **OK/√** key when the IP phone is idle to check the basic information (e.g., IP address, MAC address and firmware version).

Why doesn't the IP phone upgrade firmware successfully?

Do one of the following:

- Ensure that the target firmware is not the same as the current firmware.

- Ensure that the target firmware is applicable to the IP phone model.
- Ensure that the current or the target firmware is not protected.
- Ensure that the power is on and the network is available in the process of upgrading.
- Ensure that the web browser is not closed or refreshed when upgrading firmware via web user interface.

Why doesn't the IP phone display time and date correctly?

Check if the IP phone is configured to obtain the time and date from the NTP server automatically. If your phone is unable to access the NTP server, configure the time and date manually.

Why do I get poor sound quality during a call?

If you have poor sound quality/acoustics like intermittent voice, low volume, echo or other noises, the possible reasons could be:

- Users are seated too far out of recommended microphone range and sound faint, or are seated too close to sensitive microphones and cause echo.
- Intermittent voice is mainly caused by packet loss, due to network congestion, and jitter, due to message recombination of transmission or receiving equipment (e.g., timeout handling, retransmission mechanism, buffer under run).
- Noisy equipment, such as a computer or a fan, may cause voice interference. Turn off any noisy equipment.
- Line issues can also cause this problem; disconnect the old line and redial the call to ensure another line may provide better connection.

What is the difference between a remote phone book and a local phone book?

A remote phone book is placed on a server, while a local phone book is placed on the IP phone flash. A remote phone book can be used by everyone that can access the server, while a local phone book can only be used by a specific phone. A remote phone book is always used as a central phone book for a company; each employee can load it to obtain the real-time data from the same server.

What is the difference among user name, register name and display name?

Both user name and register name are defined by the server. User name identifies the account, while register name matched with a password is for authentication purposes. Display name is the caller ID that will be displayed on the callee’s phone LCD screen. Server configurations may override the local ones.

How to reboot the IP phone remotely?

IP phones support remote reboot by a SIP NOTIFY message with “Event: check-sync” header. Whether the IP phone reboots or not depends on the value of the parameter “sip.notify_reboot_enable”. If the value is set to 1, or the value is set to 0 and the header of the SIP NOTIFY message contains an additional string “reboot=true”, the IP phone will reboot immediately.

The NOTIFY message is formed as shown:

```
NOTIFY sip:<user>@<dsthost> SIP/2.0
To: sip:<user>@<dsthost>
From: sip:sipsak@<srchost>
CSeq: 10 NOTIFY
Call-ID: 1234@<srchost>
Event: check-sync;reboot=true
```

Procedure

Changes can only be configured using the configuration files.

<p>Configuration File</p>	<p><y0000000000xx>.cfg</p>	<p>Configure the IP phone behavior when receiving a SIP NOTIFY message which contains the header “Event: check-sync”.</p> <p>Parameter: sip.notify_reboot_enable</p>
----------------------------------	----------------------------------	---

Details of the Configuration Parameter:

Parameter	Permitted Values	Default
sip.notify_reboot_enable	0, 1 or 2	1
<p>Description:</p> <p>Configure the IP phone behavior when receiving a SIP NOTIFY message which contains the header "Event: check-sync".</p> <p>0-The IP phone will reboot only if the SIP NOTIFY message contains an additional string "reboot=true".</p> <p>1-The IP phone will be forced to reboot.</p> <p>2-The IP phone will ignore the SIP NOTIFY message.</p> <p>Web User Interface:</p> <p>None</p> <p>Phone User Interface:</p> <p>None</p>		

Why does the IP phone use DOB format logo file instead of popular BMP, JPG and so on?

The IP phone only uses logo file in DOB format, as the DOB format file has a high compression ratio (the size of the uncompressed file compared to that of the compressed file) and can be stored in smaller space. Tools for converting BMP format to DOB format are available. For more information, refer to [Customizing a Logo Template File](#) on page 164.

How to increase or decrease the volume?

Press the volume key to increase or decrease the ringer volume when the IP phone is idle, or to adjust the volume of engaged audio device (handset, speakerphone or headset) when there is an active call in progress.

What will happen if I connect both PoE cable and power adapter?

Which has the higher priority?

IP phones use the PoE preferentially.

What is auto provisioning?

Auto provisioning refers to the update of IP phones, including update on configuration parameters, local phone book, firmware and so on. You can use auto provisioning on a single phone, but it makes more sense in mass deployment.

What is PnP?

Plug and Play (PnP) is a method for IP phones to acquire the provisioning server address. With PnP enabled, the IP phone broadcasts the PnP SUBSCRIBE message to obtain a provisioning server address during startup. Any SIP server recognizing the message will respond with the preconfigured provisioning server address, so the IP phone will be able to download the CFG files from the provisioning server. PnP depends on support from a SIP server.

Why doesn't the IP phone update the configuration?

Do one of the following:

- Ensure that the configuration is set correctly.
- Reboot the phone. Some configurations require a reboot to take effect.
- Ensure that the configuration is applicable to the IP phone model.
- The configuration may depend on support from a server.

What do "on code" and "off code" mean?

They are codes that the IP phone sends to the server when a certain action takes place. On code is used to activate a feature on the server side, while off code is used to deactivate a feature on the server side.

For example, if you set the Always Forward on code to be *78 (may vary on different servers), and the target number to be 201. When you enable Always Forward on the IP phone, the IP phone sends *78201 to the server, and then the server will enable Always Forward feature on the server side, hence being able to get the right status of the extension.

For anonymous call/anonymous call rejection feature, the phone will send either the on code or off code to the server according to the value of Send Anonymous Code/Send Rejection Code. For more information, refer to [Anonymous Call](#) on page 242 and [Anonymous Call Rejection](#) on page 247.

How to solve the IP conflict problem?

Do one of the following:

- Reset another available IP address for the IP phone.
- Check network configuration via phone user interface at the path **Menu->Settings->Advanced Settings->Network->WAN Port->IPv4** (or **IPv6**). If the Static IP is selected, select DHCP instead.

How to reset the IP phone to factory configurations?

Reset your phone to factory configurations after you have tried all troubleshooting suggestions but do not solve the problem. Note that all custom settings will be overwritten after resetting.

To reset the IP phone via web user interface:

1. Click on **Settings->Upgrade**.
2. Click **Reset to Factory Setting** in the **Reset to Factory Setting** field.

The web user interface prompts the message “Do you want to reset to factory?”.

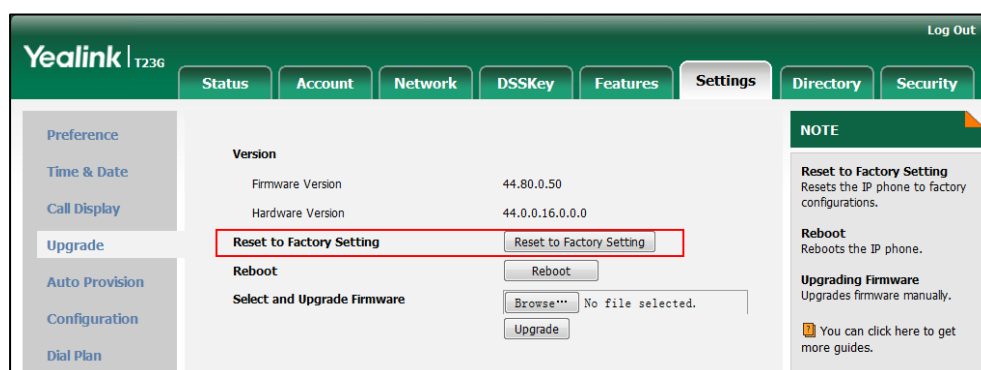

3. Click **OK** to confirm the resetting.

The IP phone will be reset to factory successfully after startup.

Note

Reset of your phone may take a few minutes. Do not power off until the phone starts up successfully.

How to restore the administrator password?

Factory reset can restore the original password. All custom settings will be overwritten after reset.

Why does the IP phone play the local ringback tone instead of media when placing a long distance number without plus 0?

Ensure that the 180 ring workaround feature is disabled. For more information, refer to [180 Ring Workaround](#) on page 269.

What communication protocols and ports do Yealink IP phones support?

Source Device	Source IP	Source Port	Destination Device	Destination IP	Destination Port (Listening port)	Protocol	Description of destination port
IP phones	IP address of IP phones	2~65535	IP Phone or voice gateway	IP address of IP phone or voice gateway	Determined by destination device.	UDP	RTP protocol port, it is used to send or receive audio stream.
		1024~65535	SIP Server	IP address of SIP server	Determined by destination device.	UDP/TCP	SIP protocol port, it is used for signaling interaction with SIP server.
		1024~65535	TR-069 Server	IP address of TR-069 server	Determined by destination device.	TCP	TR-069 protocol port, it is used to communicate with TR-069server.
		1024~65535	File server	IP address of file server	Determined by destination device.	TCP	HTTP protocol port, it is used to download file.
		1024~65535	Remote phone book server	IP address of remote phone book server	Determined by destination device.	TCP	HTTP protocol port, it is used to access the remote phone book.
		1024~65535	AA	IP address of AA	Determined by destination device.	TCP	HTTP protocol port, it is used for AA communication.
		1024~65535	SNMP Server	IP address of SNMP server	Determined by destination device.	UDP	SNMP protocol port, it is used to communicate with SNMP server.

Source Device	Source IP	Source Port	Destination Device	Destination IP	Destination Port (Listening port)	Protocol	Description of destination port
		68	DHCP Server	IP address of DHCP server	67	UDP	DHCP protocol port, it is used to obtain IP address from DHCP server.
		1024~65535	LDAP Server	IP address of LDAP server	Determined by destination device.	TCP	LDAP protocol port, it is used to obtain the contact information from LDAP server.
		1024~65535	NTP Server	IP address of NTP server	123	UDP	NTP protocol port, it is used to synchronize time from NTP time server.
		1024~65535	Syslog Server	IP address of syslog server	514	UDP	Syslog protocol port, it is used for IP phones to upload syslog information to syslog server.
		1024~65535	PNP Server	IP address of PNP server (Default value: 224.0.1.75)	5059	UDP/TCP	Protocol port, it is used to obtain the URL of updating file from PNP server.
			Multipaging	Multipaging	65000 65001		
PC	IP address of PC				1~65535	TCP	HTTP port (default value: 80)
					1~65535	TCP	HTTP port (default value: 443)
SIP	IP				1024~65534	UDP/TCP	SIP protocol port, it is used for

Source Device	Source IP	Source Port	Destination Device	Destination IP	Destination Port (Listening port)	Protocol	Description of destination port
Server	address of SIP Server	Determined by the destination device.	IP phones	IP address of IP phones			signaling interaction with SIP server.
IP Phone of voice gateway	IP address of IP phone or voice gateway				2~65535	UDP	RTP protocol port, it is used by destination device to send or receive audio stream.
TR-069 Server	IP address of TR-069 Server				1024~65535	TCP	TR-069 protocol port, it is used to communicate with TR-069server.

What is the difference between enabling and disabling the RFC 2543 Hold feature?

Capturing packets after you enable the RFC 2543 Hold feature. SDP media direction attributes (such as a=sendonly) per RFC 2543 is used in the INVITE message when placing a call on hold.

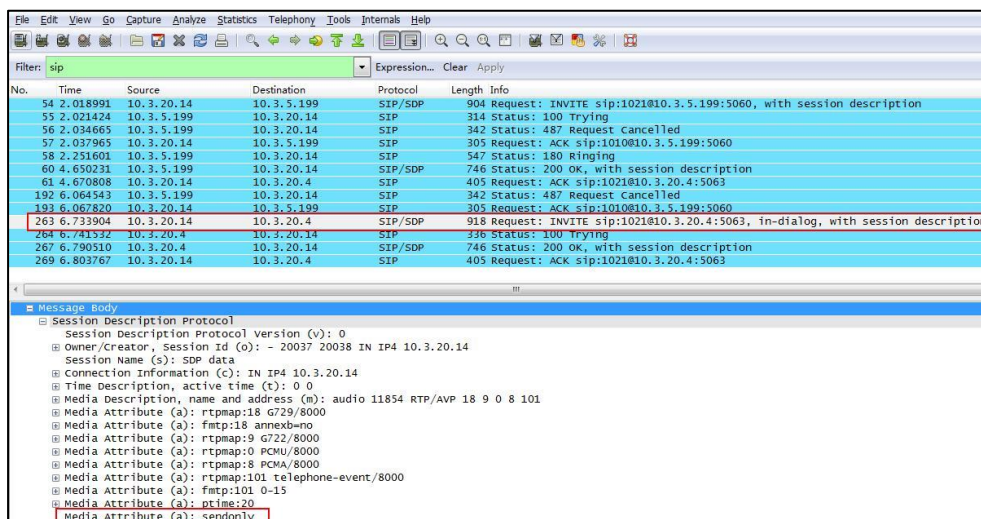

Capturing packets after you disable the RFC 2543 Hold feature. SDP media connection address c=0.0.0.0 per RFC 3264 is used in the INVITE message when placing a call on hold.

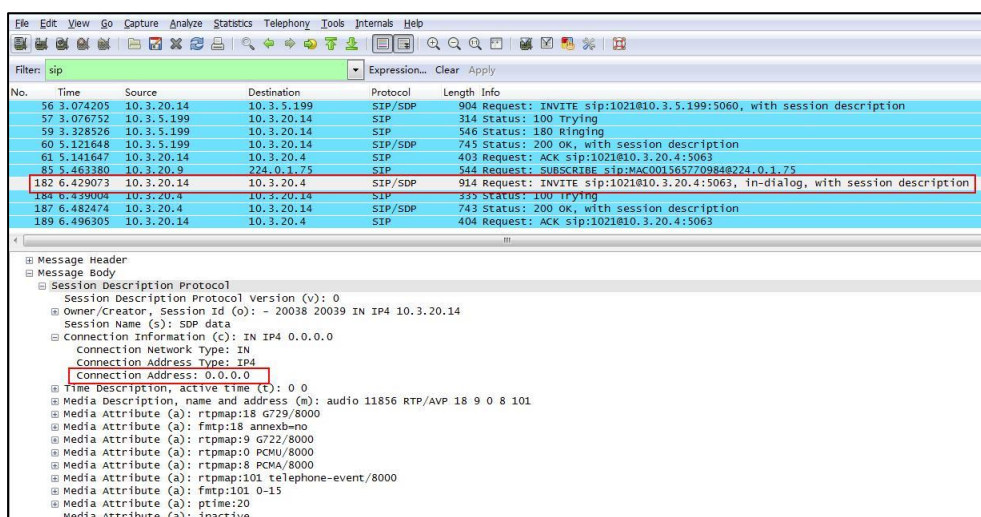

For more information on RFC 2543 hold feature, refer to [Call Hold](#) on page 278. For more information on capturing packets, refer to [Capturing Packets](#) on page 725.

How can I verify the firmware generation and version of the phone?

Press the **OK/V** key when the IP phone is idle to check the firmware version. For example: 44.80.0.50.

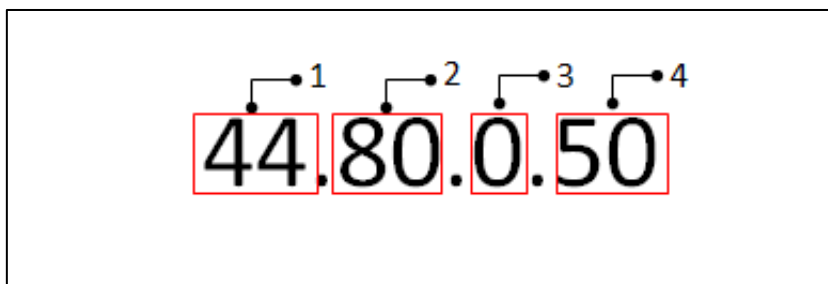

	Item	Description
1	44	<p>Hardware version.</p> <p>The hardware version for each IP phone model is:</p> <ul style="list-style-type: none"> • 35: SIP-T48G • 28: SIP-T46G • 29: SIP-T42G • 36: SIP-T41P • 46: SIP-T29G • 45: SIP-T27P • 44: SIP-T23P/G • 52: SIP-T21(P) E2 • 53: SIP-T19(P) E2
2	80	<p>Firmware generation.</p> <p>Note: The larger it is, the newer the firmware generation is.</p>
3	0	A fixed number.
4	50	<p>Firmware version.</p> <p>Note: With the same firmware generation, the larger it is, the newer the firmware version is.</p>

Appendix

Appendix A: Glossary

802.1x--an IEEE Standard for port-based Network Access Control (PNAC). It is a part of the IEEE 802.1 group of networking protocols. It provides an authentication mechanism to devices wishing to attach to a LAN or WLAN.

ACS (Auto Configuration server)--responsible for auto-configuration of the Central Processing Element (CPE).

Cryptographic Key--a piece of variable data that is fed as input into a cryptographic algorithm to perform operations such as encryption and decryption, or signing and verification.

DHCP (Dynamic Host Configuration Protocol)--built on a client-server model, where designated DHCP server hosts allocate network addresses and deliver configuration parameters to dynamically configured hosts.

DHCP Option--can be configured for specific values and enabled for assignment and distribution to DHCP clients based on server, scope, class or client-specific levels.

DNS (Domain Name System)--a hierarchical distributed naming system for computers, services, or any resource connected to the Internet or a private network.

EAP-MD5 (Extensible Authentication Protocol-Message Digest Algorithm 5)--only provides authentication of the EAP peer to the EAP server but not mutual authentication.

EAP-TLS (Extensible Authentication Protocol-Transport Layer Security) --provides for mutual authentication, integrity-protected cipher suite negotiation between two endpoints.

PEAP-MSCHAPv2 (Protected Extensible Authentication Protocol-Microsoft Challenge Handshake Authentication Protocol version 2) --provides for mutual authentication, but does not require a client certificate on the IP phone.

FAC (Feature Access Code)--special patterns of characters that are dialed from a phone keypad to invoke particular features.

HTTP (Hypertext Transfer Protocol)--used to request and transmit data on the World Wide Web.

HTTPS (Hypertext Transfer Protocol over Secure Socket Layer)--a widely-used communications protocol for secure communication over a network.

IEEE (Institute of Electrical and Electronics Engineers)--a non-profit professional association headquartered in New York City that is dedicated to advancing

technological innovation and excellence.

LAN (Local Area Network)--used to interconnects network devices in a limited area such as a home, school, computer laboratory, or office building.

MIB (Management Information Base)--a virtual database used for managing the entities in a communications network.

OID (Object Identifier)--assigned to an individual object within a MIB.

PnP (Plug and Play)--a term used to describe the characteristic of a computer bus, or device specification, which facilitates the discovery of a hardware component in a system, without the need for physical device configuration, or user intervention in resolving resource conflicts.

ROM (Read-only Memory)--a class of storage medium used in computers and other electronic devices.

RTP (Real-time Transport Protocol)--provides end-to-end service for real-time data.

TCP (Transmission Control Protocol)--a transport layer protocol used by applications that require guaranteed delivery.

UDP (User Datagram Protocol)--a protocol offers non-guaranteed datagram delivery.

URI (Uniform Resource Identifier)--a compact sequence of characters that identifies an abstract or physical resource.

URL (Uniform Resource Locator)--specifies the address of an Internet resource.

VLAN (Virtual LAN)-- a group of hosts with a common set of requirements, which communicate as if they were attached to the same broadcast domain, regardless of their physical location.

VoIP (Voice over Internet Protocol)--a family of technologies used for the delivery of voice communications and multimedia sessions over IP networks.

WLAN (Wireless Local Area Network)--a type of local area network that uses high-frequency radio waves rather than wires to communicate between nodes.

XML-RPC (Remote Procedure Call Protocol)--which uses XML to encode its calls and HTTP as a transport mechanism.

Appendix B: Time Zones

Time Zone	Time Zone Name
-11	Samoa
-10	US-Hawaii-Aleutian, US-Alaska-Aleutian
-9:30	French Polynesia
-9	US-Alaska Time
-8	Canada(Vancouver,Whitehorse), Mexico(Tijuana,Mexicali), US-Pacific Time
-7	Canada(Edmonton,Calgary), Mexico(Mazatlan,Chihuahua), US-MST no DST, US-Mountain Time
-6	Canada-Manitoba(Winnipeg), Chile(Easter Islands), Mexico(Mexico City,Acapulco), US-Central Time
-5	Bahamas(Nassau), Canada(Montreal,Ottawa,Quebec), Cuba(Havana), US-Eastern Time
-4:30	Venezuela(Caracas)
-4	Canada(Halifax,Saint John), Chile(Santiago), Paraguay(Asuncion), UK(Falkland Islands), UK-Bermuda(Bermuda), Trinidad&Tobago
-3:30	Canada-New Foundland(St.Johns)
-3	Argentina(Buenos Aires), Brazil(DST), Brazil(no DST), Denmark-Greenland(Nuuk)
-2:30	Newfoundland and Labrador
-2	Brazil(no DST)
-1	Portugal(Azores)
0	Denmark-Faroe Islands(Torshavn), GMT, Greenland, Ireland(Dublin), Morocco, Portugal(Lisboa,Porto,Funchal), Spain-Canary Islands(Las Palmas),UK(London)
+1	Albania(Tirane), Austria(Vienna), Belgium(Brussels), Caicos, Chad, Croatia(Zagreb), Czech Republic(Prague), Denmark(Kopenhagen), France(Paris), Germany(Berlin), Hungary(Budapest), Italy(Rome), Luxembourg(Luxembourg), Macedonia(Skopje), Namibia(Windhoek), Netherlands(Amsterdam), Spain(Madrid)
+2	Estonia(Tallinn), Finland(Helsinki), Gaza Strip(Gaza), Greece(Athens), Israel(Tel Aviv), Jordan(Amman), Latvia(Riga), Lebanon(Beirut), Moldova(Kishinev), Romania(Bucharest), Russia(Kaliningrad), Syria(Damascus), Turkey(Ankara), Ukraine(Kyiv, Odessa)
+3	East Africa Time, Iraq(Baghdad), Russia(Moscow)
+3:30	Iran(Teheran)
+4	Armenia(Yerevan), Azerbaijan(Baku), Georgia(Tbilisi), Kazakhstan(Aktau), Russia(Samara)

Time Zone	Time Zone Name
+4:30	Afghanistan(Kabul)
+5	Kazakhstan(Aqtobe), Kyrgyzstan(Bishkek), Pakistan(Islamabad), Russia(Chelyabinsk)
+5:30	India(Calcutta)
+5:45	Nepal(Katmandu)
+6	Kazakhstan(Astana, Almaty), Russia(Novosibirsk,Omsk)
+6:30	Myanmar(Naypyitaw)
+7	Russia(Krasnoyarsk), Thailand(Bangkok)
+8	Australia(Perth), China(Beijing), Russia(Irkutsk, Ulan-Ude), Singapore(Singapore)
+8:45	Eucla
+9	Japan(Tokyo), Korea(Seoul), Russia(Yakutsk,Chita)
+9:30	Australia(Adelaide), Australia(Darwin)
+10	Australia(Brisbane), Australia(Hobart), Australia(Sydney,Melbourne,Canberra), Russia(Vladivostok)
+10:30	Australia(Lord Howe Islands)
+11	New Caledonia(Noumea), Russia(Srednekolymsk Time)
+11:30	Norfolk Island
+12	New Zealand(Wellington,Auckland), Russia(Kamchatka Time)
+12:45	New Zealand(Chatham Islands)
+13	Tonga(Nukualofa)
+13:30	Chatham Islands
+14	Kiribati

Appendix C: Trusted Certificates

Yealink IP phones trust the following CAs by default:

- DigiCert High Assurance EV Root CA
- Deutsche Telekom AG Root CA-2
- Equifax Secure Certificate Authority
- Equifax Secure eBusiness CA-1
- Equifax Secure Global eBusiness CA-1
- GeoTrust Global CA
- GeoTrust Global CA2
- GeoTrust Primary CA
- GeoTrust Primary CA G2 ECC
- GeoTrust Universal CA
- GeoTrust Universal CA2
- Thawte Personal Freemail CA
- Thawte Premium Server CA

- Thawte Primary Root CA - G1 (EV)
- Thawte Primary Root CA - G2 (ECC)
- Thawte Primary Root CA - G3 (SHA256)
- Thawte Server CA
- VeriSign Class 1 Public Primary Certification Authority
- VeriSign Class 1 Public Primary Certification Authority - G2
- VeriSign Class 1 Public Primary Certification Authority - G3
- VeriSign Class 2 Public Primary Certification Authority - G2
- VeriSign Class 2 Public Primary Certification Authority - G3
- VeriSign Class 3 Public Primary Certification Authority
- VeriSign Class 3 Public Primary Certification Authority - G2
- VeriSign Class 3 Public Primary Certification Authority - G3
- VeriSign Class 3 Public Primary Certification Authority - G4
- VeriSign Class 3 Public Primary Certification Authority - G5
- VeriSign Class 4 Public Primary Certification Authority - G2
- VeriSign Class 4 Public Primary Certification Authority - G3
- VeriSign Universal Root Certification Authority

Note

Yealink endeavors to maintain a built-in list of most common used CA Certificates. Due to memory constraints, we cannot ensure a complete set of certificates. If you are using a certificate from a commercial Certificate Authority not in the list above, you can send a request to your local distributor. At this point, you can upload your particular CA certificate into your phone. For more information on uploading custom CA certificate, refer to [Transport Layer Security](#) on page 684.

Appendix D: Configuring DSS Key

This section provides the DSS key parameters you can configure on IP phones. DSS key consists of line key (line key is not applicable to SIP-T19(P) E2 IP phones), programable key and ext key (ext key is only applicable to SIP-T48G/T46G/T29G/T27P IP phones). The following table lists the number of DSS keys you can configure for each phone model:

Phone Model	Line Key	Programable Key	Ext Key
SIPT48G	29	13	39
SIPT46G	27	13	39
SIPT42G	15	11	/
SIPT41P	15	11	/
SIPT29G	27	14	39

Phone Model	Line Key	Programmable Key	Ext Key
SIP-T27P	21	14	39
SIP-T23P/G	3	11	/
SIP-T21(P) E2	2	11	/
SIP-T19(P) E2	/	11	/

Note

The programmable key takes effect only if the IP phone is idle.
 The ext key takes effect only if the expansion module is connected to the IP phone.

The following tables list relationship between the values of X in the following parameters and programmable keys for each phone model.

X ranges from 1 to 14.

- programmablekey.X.type =
- programmablekey.X.line =
- programmablekey.X.value =
- programmablekey.X.xml_phonebook =
- programmablekey.X.history_type =
- programmablekey.X.pickup_value =

X ranges from 1 to 4.

- programmablekey.X.label =

X \ Phone Model	SIP-T19(P) E2	SIP-T23P/T23G/ T21(P) E2	SIP-T29G/ T27P	SIP-T42G/ T41P	SIP-T48G/ T46G
1	SoftKey1	SoftKey1	SoftKey1	SoftKey1	SoftKey1
2	SoftKey2	SoftKey2	SoftKey2	SoftKey2	SoftKey2
3	SoftKey3	SoftKey3	SoftKey3	SoftKey3	SoftKey3
4	SoftKey4	SoftKey4	SoftKey4	SoftKey4	SoftKey4
5	Up	Up	Up	Up	Up
6	Down	Down	Down	Down	Down
7	Left	Left	Left	Left	Left
8	Right	Right	Right	Right	Right
9	OK	OK	OK	OK	OK
10		Cancel	Cancel	Cancel	Cancel
11			CONF		

X \ Phone Model	SIPT19(P) E2	SIPT23P/T23G/ T21(P) E2	SIPT29G/ T27P	SIPT42G/ T41P	SIPT48G/ T46G
12			Hold		Hold
13	Mute		Mute	Mute	Mute
14	TRAN	TRAN	TRAN		TRAN

DSS key can be assigned with various key features. The parameters of the DSS key are detailed in the following:

Parameter linekey.X.type	Configuration File <y0000000000xx>.cfg
Parameter programablekey.X.type	
Parameter expansion_module.X.key.Y.type	
Description	<p>Configures key feature for the DSS key.</p> <p>For line keys (not applicable to SIPT19(P) E2 IP phones):</p> <p>X ranges from 1 to 29 (for SIPT48G)</p> <p>X ranges from 1 to 27 (for SIPT46G/T29G)</p> <p>X ranges from 1 to 15 (for SIPT42G/T41P)</p> <p>X ranges from 1 to 21 (for SIPT27P)</p> <p>X ranges from 1 to 3 (for SIPT23P/G)</p> <p>X ranges from 1 to 2 (for SIPT21(P) E2)</p> <p>For programmable keys:</p> <p>X=1-10, 12-14 (for SIPT48G/T46G)</p> <p>X=1-10, 13 (for SIPT42G/T41P)</p> <p>X=1-14 (for SIPT29G/T27P)</p> <p>X=1-10, 14 (for SIPT23P/T23G/T21(P) E2)</p> <p>X=1-9, 13, 14 (for SIPT19(P) E2)</p> <p>For ext keys (only applicable to SIPT48G/T46G/T29G/T27P IP phones):</p> <p>X ranges from 1 to 6, Y ranges from 1 to 20, 22 to 40 (Ext key 21 cannot be configured).</p> <p>For line keys:</p>

	<p>Valid types are:</p> <ul style="list-style-type: none">0-N/A1-Conference2-Forward3-Transfer4-Hold5-DND7-ReCall8-SMS9-Direct Pickup10-Call Park11-DTMF12-Voice Mail13-Speed Dial14-Intercom15-Line16-BLF17-URL18-Group Listening20-Private Hold22-XML Group23-Group Pickup24-Multicast Paging25-Record27-XML Browser34-Hot Desking35-URL Record37-Switch38-LDAP39-BLF List40-Prefix41-Zero Touch42-ACD45-Local Group50-Phone Lock61-Directory66-Paging List
--	---

	<p>For programable keys:</p> <p>Valid types are:</p> <p>0-N/A</p> <p>2-Forward</p> <p>5-DND</p> <p>7-ReCall</p> <p>8-SMS</p> <p>9-Direct Pickup</p> <p>13-Speed Dial</p> <p>22-XML Group</p> <p>23-Group Pickup</p> <p>27-XML Browser</p> <p>28-History</p> <p>30-Menu</p> <p>32-New SMS</p> <p>33-Status</p> <p>34-Hot Desking (only applicable to SIP-T48G/T46G/T29G/T19(P) E2 IP phones)</p> <p>38-LDAP (not applicable to SIP-T19(P) E2 IP phones)</p> <p>40-Prefix</p> <p>41-Zero Touch</p> <p>43-Local Directory</p> <p>45-Local Group</p> <p>47-XML Directory</p> <p>50-Phone Lock</p> <p>51-Switch Account Up</p> <p>52-Switch Account Down</p> <p>61-Directory</p> <p>66-Paging List</p> <p>For ext keys:</p> <p>Valid types are:</p> <p>0-NA</p> <p>1-Conference</p> <p>2-Forward</p> <p>3-Transfer</p> <p>4-Hold</p>
--	---

	<p>5-DND</p> <p>7-ReCall</p> <p>8-SMS</p> <p>9-Direct Pickup</p> <p>10-Call Park</p> <p>11-DTMF</p> <p>12-Voice Mail</p> <p>13-Speed Dial</p> <p>14-Intercom</p> <p>15-Line</p> <p>16-BLF</p> <p>17-URL</p> <p>18-Group Listening</p> <p>20-Private Hold</p> <p>22-XML Group</p> <p>23-Group Pickup</p> <p>24-Multicast Paging</p> <p>25-Record</p> <p>27-XML Browser</p> <p>34-Hot Desking</p> <p>35-URL Record</p> <p>37-Switch (only applicable to ext key 1)</p> <p>38-LDAP</p> <p>39-BLF List</p> <p>40-Prefix</p> <p>41-Zero Touch</p> <p>42-ACD</p> <p>45-Local Group</p> <p>50-Phone Lock</p> <p>61-Directory</p> <p>66-Paging List</p>
Format	Integer
Default Value	<p>For line keys:</p> <p>For SIP-T48G IP phones:</p> <p>The default value of the line key 1-16 is 15, and the default value of the line key 17-29 is 0.</p> <p>For SIP-T46G/T29G IP phones:</p>

	<p>The default value of the line key 1-16 is 15, and the default value of the line key 17-27 is 0.</p> <p>For SIP-T42G IP phones:</p> <p>The default value of the line key 1-12 is 15, and the default value of the line key 13-15 is 0.</p> <p>For SIP-T41P IP phones:</p> <p>The default value of the line key 1-6 is 15, and the default value of the line key 7-15 is 0.</p> <p>For SIP-T27P IP phones:</p> <p>The default value of the line key 1-6 is 15, and the default value of the line key 7-21 is 0.</p> <p>For SIP-T23P/T23G/T21(P) E2 IP phones:</p> <p>The default value is 15.</p> <p>For programable keys:</p> <p>For SIP-T48G/T46G IP phones:</p> <p>When X=1, the default value is 28 (History). When X=2, the default value is 61 (Directory). When X=3, the default value is 5 (DND). When X=4, the default value is 30 (Menu). When X=5, the default value is 28 (History). When X=6, the default value is 61 (Directory). When X=7, the default value is 0 (NA). When X=8, the default value is 0 (NA). When X=9, the default value is 33 (Status). When X=10, the default value is 0 (NA). When X=12, the default value is 0 (NA). When X=13, the default value is 0 (NA). When X=14, the default value is 2 (Forward).</p> <p>For SIP-T42G/T41P IP phones:</p> <p>When X=1, the default value is 28 (History). When X=2, the default value is 61 (Directory). When X=3, the default value is 5 (DND). When X=4, the default value is 30 (Menu). When X=5, the default value is 28 (History). When X=6, the default value is 61 (Directory). When X=7, the default value is 0 (NA). When X=8, the default value is 0 (NA).</p>
--	--

	<p>When X=9, the default value is 33 (Status).</p> <p>When X=10, the default value is 0 (NA).</p> <p>When X=13, the default value is 0 (NA).</p> <p>For SIP-T29G/T27P IP phones:</p> <p>When X=1, the default value is 28 (History).</p> <p>When X=2, the default value is 61 (Directory).</p> <p>When X=3, the default value is 5 (DND).</p> <p>When X=4, the default value is 30 (Menu).</p> <p>When X=5, the default value is 28 (History).</p> <p>When X=6, the default value is 61 (Directory).</p> <p>When X=7, the default value is 0 (NA).</p> <p>When X=8, the default value is 0 (NA).</p> <p>When X=9, the default value is 33 (Status).</p> <p>When X=10, the default value is 0 (NA).</p> <p>When X=11, the default value is 0 (NA).</p> <p>When X=12, the default value is 0 (NA).</p> <p>When X=13, the default value is 0 (NA).</p> <p>When X=14, the default value is 2 (Forward).</p> <p>For SIP-T23P/T23G/T21(P) E2 IP phones:</p> <p>When X=1, the default value is 28 (History).</p> <p>When X=2, the default value is 61 (Directory).</p> <p>When X=3, the default value is 5 (DND).</p> <p>When X=4, the default value is 30 (Menu).</p> <p>When X=5, the default value is 28 (History).</p> <p>When X=6, the default value is 61 (Directory).</p> <p>When X=7, the default value is 0 (NA).</p> <p>When X=8, the default value is 0 (NA).</p> <p>When X=9, the default value is 33 (Status).</p> <p>When X=10, the default value is 0 (NA).</p> <p>When X=14, the default value is 2 (Forward).</p> <p>For SIP-T19(P) E2 IP phones:</p> <p>When X=1, the default value is 28 (History).</p> <p>When X=2, the default value is 61 (Directory).</p> <p>When X=3, the default value is 5 (DND).</p> <p>When X=4, the default value is 30 (Menu).</p> <p>When X=5, the default value is 28 (History).</p> <p>When X=6, the default value is 61 (Directory).</p>
--	--

	<p>When X=7, the default value is 0 (NA).</p> <p>When X=8, the default value is 0 (NA).</p> <p>When X=9, the default value is 33 (Status).</p> <p>When X=13, the default value is 0 (NA).</p> <p>When X=14, the default value is 2 (Forward).</p> <p>For ext keys:</p> <p>For SIP-T48G/T46G/T29G/T27P IP phones:</p> <p>The default value of the ext key 1, 21 is 37, and the default value of the ext key 2-20, 22-40 is 0.</p>
Range	<p>Valid values are:</p> <p>0-N/A</p> <p>1-Conference</p> <p>2-Forward</p> <p>3-Transfer</p> <p>4-Hold</p> <p>5-DND</p> <p>7-ReCall</p> <p>8-SMS</p> <p>9-Direct Pickup</p> <p>10-Call Park</p> <p>11-DTMF</p> <p>12-Voice Mail</p> <p>13-Speed Dial</p> <p>14-Intercom</p> <p>15-Line</p> <p>16-BLF</p> <p>17-URL</p> <p>18-Group Listening</p> <p>20-Private Hold</p> <p>22-XML Group</p> <p>23-Group Pickup</p> <p>24-Multicast Paging</p> <p>25-Record</p> <p>27-XML Browser</p> <p>28-History</p> <p>30-Menu</p> <p>32-New SMS</p>

	<p>33-Status</p> <p>34-Hot Desking</p> <p>35-URL Record</p> <p>37-Switch</p> <p>38-LDAP</p> <p>39-BLF List</p> <p>40-Prefix</p> <p>41-Zero Touch</p> <p>42-ACD</p> <p>43-Local Directory</p> <p>45-Local Group</p> <p>47-XML Directory</p> <p>50-Phone Lock</p> <p>51-Switch Account Up</p> <p>52-Switch Account Down</p> <p>61-Directory</p> <p>66-Paging List</p>
Example	linekey.1.type = 8

Parameter- linekey.X.line	<p>Configuration File</p> <p><y0000000000xx>.cfg</p>
Parameter- programablekey.X.line	
Parameter- expansion_module.X.key.Y.line	
Description	<p>Configures the desired line to apply the key feature. (not applicable to SIP-T19(P) E2 IP phones)</p> <p>For line keys:</p> <p>X ranges from 1 to 29 (for SIP-T48G)</p> <p>X ranges from 1 to 27 (for SIP-T46G/T29G)</p> <p>X ranges from 1 to 15 (for SIP-T42G/T41P)</p> <p>X ranges from 1 to 21 (for SIP-T27P)</p> <p>X ranges from 1 to 3 (for SIP-T23P/G)</p> <p>X ranges from 1 to 2 (for SIP-T21(P) E2)</p>

	<p>For programmable keys:</p> <p>X=1-10, 12-14 (for SIP-T48G/T46G)</p> <p>X=1-10, 13 (for SIP-T42G/T41P)</p> <p>X=1-14 (for SIP-T29G/T27P)</p> <p>X=1-10, 14 (for SIP-T23P/T23G/T21(P) E2)</p> <p>For ext keys (only applicable to SIP-T48G/T46G/T29G/T27P IP phones):</p> <p>X ranges from 1 to 6, Y ranges from 1 to 20, 22 to 40 (Ext key 21 cannot be configured).</p> <p>When assigning the following features, you do not need to configure this parameter:</p> <ul style="list-style-type: none">1-Conference2-Forward3-Transfer4-Hold5-DND7-ReCall8-SMS9-Direct Pickup11-DTMF17-URL18-Group Listening20-Private Hold22-XML Group24-Multicast Paging25-Record27-XML Browser34-Hot Desking35-URL Record38-LDAP39-BLF List40-Prefix41-Zero Touch42-ACD45-Local Group50-Phone Lock61-Directory
--	---

	66-Paging List
Format	Integer
Default Value	For the programable key and ext key, the default value is not applicable. For the line key, when X=1, the default value is 1. When X=2, the default value is 2. When X=3 the default value is 3 ... When X=16 the default value is 16.
Range	Permitted Values: 1 to 16 (for SIP-T48G/T46G/T29G) 1 to 12 (for SIP-T42G) 1 to 6 (for SIP-T41P/T27P) 1 to 3 (for SIP-T23P/G) 1 to 2 (for SIP-T21(P) E2) 1-Line 1 2-Line 2 ... 16-Line 16
Example	linekey.1.line = 2

Parameter- linekey.X.value	Configuration File <y0000000000xx>.cfg
Parameter- programablekey.X.value	
Parameter- expansion_module.X.key.Y.value	
Description	Configures the value for some key features. For line keys (not applicable to SIP-T19(P) E2 IP phones): X ranges from 1 to 29 (for SIP-T48G) X ranges from 1 to 27 (for SIP-T46G/T29G) X ranges from 1 to 15 (for SIP-T42G/T41P) X ranges from 1 to 21 (for SIP-T27P)

	<p>X ranges from 1 to 3 (for SIP-T23P/G)</p> <p>X ranges from 1 to 2 (for SIP-T21(P) E2)</p> <p>For programable keys:</p> <p>X=1-10, 12-14 (for SIP-T48G/T46G)</p> <p>X=1-10, 13 (for SIP-T42G/T41P)</p> <p>X=1-14 (for SIP-T29G/T27P)</p> <p>X=1-10, 14 (for SIP-T23P/T23G/T21(P) E2)</p> <p>X=1-9, 13, 14 (for SIP-T19(P) E2)</p> <p>For ext keys (only applicable to SIP-T48G/T46G/T29G/T27P IP phones):</p> <p>X ranges from 1 to 6, Y ranges from 1 to 20, 22 to 40 (Ext key 21 cannot be configured).</p>
Format	String
Default Value	Blank
Range	String within 99 characters
Example	<p>When you assign the Speed Dial to the line key, this parameter is used to specify the number you want to dial out.</p> <p>linekey.1.value = 1001</p>

Parameter- linekey.X.label	Configuration File <y0000000000xx>.cfg
Parameter- programablekey.X.label	
Parameter- expansion_module.X.key.Y.label	
Description	<p>(Optional.) Configures the label displaying on the LCD screen for each line key and each soft key.</p> <p>This is an optional configuration.</p> <p>For line keys (not applicable to SIP-T19(P) E2 IP phones):</p> <p>X ranges from 1 to 29 (for SIP-T48G)</p> <p>X ranges from 1 to 27 (for SIP-T46G/T29G)</p> <p>X ranges from 1 to 15 (for SIP-T42G/T41P)</p> <p>X ranges from 1 to 21 (for SIP-T27P)</p> <p>X ranges from 1 to 3 (for SIP-T23P/G)</p>

	<p>X ranges from 1 to 2 (for SIP-T21(P) E2)</p> <p>X is equal to 1 (for SIP-T19(P) E2)</p> <p>For programmable keys:</p> <p>X ranges from 1 to 4.</p> <p>For ext keys (only applicable to SIP-T48G/T46G/T29G/T27P IP phones):</p> <p>X ranges from 1 to 6, Y ranges from 1 to 40. (Ext key 21 cannot be configured.)</p>
Format	String
Default Value	Blank
Range	String within 99 characters
Example	linekey.1.label = Dir

Parameter- linekey.X.pickup_value	Configuration File <y0000000000xx>.cfg
Parameter- expansion_module.X.key.Y.pickup_value	
Description	<p>Configures the pickup code for BLF feature. (not applicable to SIP-T19(P) E2 IP phones)</p> <p>This parameter is only applicable to BLF feature.</p> <p>For line keys:</p> <p>X ranges from 1 to 29 (for SIP-T48G)</p> <p>X ranges from 1 to 27 (for SIP-T46G/T29G)</p> <p>X ranges from 1 to 15 (for SIP-T42G/T41P)</p> <p>X ranges from 1 to 21 (for SIP-T27P)</p> <p>X ranges from 1 to 3 (for SIP-T23P/G)</p> <p>X ranges from 1 to 2 (for SIP-T21(P) E2)</p> <p>For ext keys (only applicable to SIP-T48G/T46G/T29G/T27P IP phones):</p> <p>X ranges from 1 to 6, Y ranges from 1 to 20, 22 to 40 (Ext key 21 cannot be configured).</p>

Format	String
Default Value	Blank
Range	String within 256 characters
Example	linekey.1.pickup_value = *88

Parameter- linekey.X.xml_phonebook	Configuration File <y0000000000xx>.cfg
Parameter- programablekey.X.xml_phonebook	
Parameter- expansion_module.X.key.Y.xml_phonebook	
Description	<p>Configures the desired group or remote phone book when multiple groups or remote phone books are configured on the IP phone.</p> <p>This parameter is only applicable to Local Group/XML Group features.</p> <p>For line keys (not applicable to SIP-T19(P) E2 IP phones):</p> <p>X ranges from 1 to 29 (for SIP-T48G)</p> <p>X ranges from 1 to 27 (for SIP-T46G/T29G)</p> <p>X ranges from 1 to 15 (for SIP-T42G/T41P)</p> <p>X ranges from 1 to 21 (for SIP-T27P)</p> <p>X ranges from 1 to 3 (for SIP-T23P/G)</p> <p>X ranges from 1 to 2 (for SIP-T21(P) E2)</p> <p>For programmable keys:</p> <p>X=1-10, 12-14 (for SIP-T48G/T46G)</p> <p>X=1-10, 13 (for SIP-T42G/T41P)</p> <p>X=1-14 (for SIP-T29G/T27P)</p> <p>X=1-10, 14 (for SIP-T23P/T23G/T21(P) E2)</p> <p>X=1-9, 13, 14 (for SIP-T19(P) E2)</p> <p>For ext keys (only applicable to SIP-T48G/T46G/T29G/T27P IP phones):</p> <p>X ranges from 1 to 6, Y ranges from 1 to 20, 22 to</p>

	<p>40 (Ext key 21 cannot be configured).</p> <p>When the key feature is configured as Local Group, valid values are:</p> <p>0-All contacts</p> <p>1-First local group</p> <p>...</p> <p>5-Fifth local group</p> <p>...</p> <p>48-Forty-eighth local group</p> <p>When the key feature is configured as XML Group (remote phone book), valid values are:</p> <p>0-First XML group</p> <p>1-Second XML group</p> <p>...</p> <p>4-Fifth XML group</p>
Format	Integer
Default Value	0
Range	0 to 48
Example	Configures the second remote phone book. linekey.1.xml_phonebook = 1

Appendix E: Auto Provisioning Flowchart (Keep user personalized configuration settings)

The following shows auto provisioning flowchart for Yealink IP phones when a user wishes to keep user personalized configuration settings.

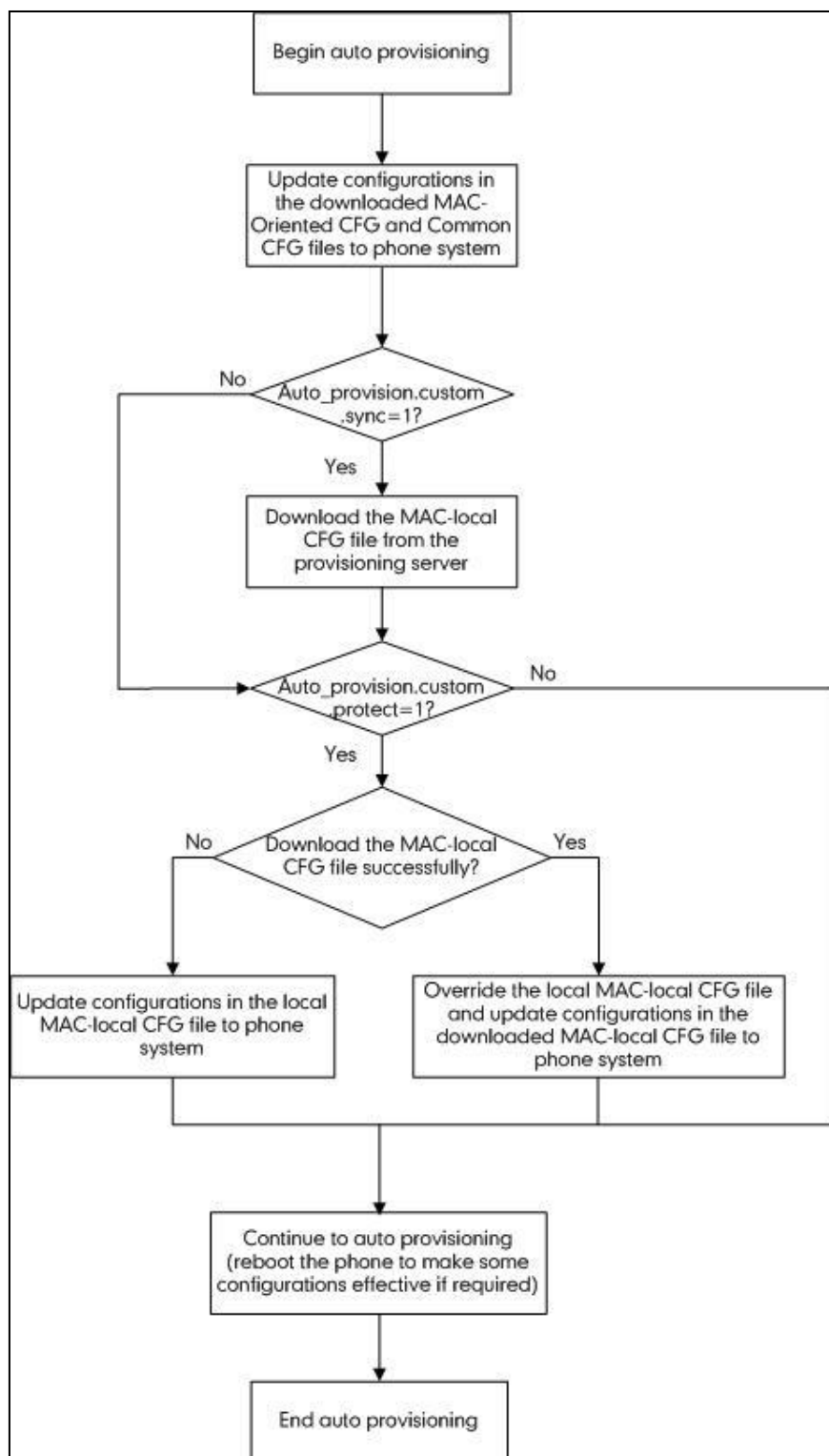

Appendix F: Configurations Defined Never be Saved to <MAC>-local.cfg file

The following tables list all the configurations defined never be saved to <MAC>-local.cfg file.

Item	Configurations
Server Type	account.X.sip_server_type
	account.X.xsi.server_type
Network	network.dhcp_host_name
	network.pppoe.user
	network.pppoe.password
	network.pc_port.enable
	network.internet_port.speed_duplex
	network.pc_port.speed_duplex
	network.static_dns_enable
	network.ipv6_static_dns_enable
	network.vlan.pc_port_mode
	network.dns.ttl_enable
	network.mtu_value
	network.vlan.internet_port_enable
	network.vlan.internet_port_vid
	network.vlan.internet_port_priority
	network.vlan.pc_port_enable
	network.vlan.pc_port_vid
	network.vlan.pc_port_priority
	network.vlan.dhcp_enable
	network.vlan.dhcp_option
	network.vlan.vlan_change.enable
network.port.http	
network.port.https	
network.qos.rtpptos	
network.qos.signalptos	

Item	Configurations
	network.802_1x.mode
	network.802_1x.identity
	network.802_1x.md5_password
	network.802_1x.root_cert_url
	network.802_1x.client_cert_url
	network.802_1x.proxy_eap_logoff.enable
	network.vpn_enable
	network.lldp.enable
	network.lldp.packet_interval
	network.span_to_pc_port
	network.port.max_rtpport
	network.port.min_rtpport
	network.ipv6_prefix
	network.ipv6_internet_port.type
	network.ipv6_internet_port.ip
	network.ipv6_internet_port.gateway
	network.ipv6_primary_dns
	network.ipv6_secondary_dns
	network.ipv6_icmp_v6.enable
	network.internet_port.type
	network.internet_port.ip
	network.internet_port.mask
	network.internet_port.gateway
	network.primary_dns
	network.secondary_dns
Openvpn	openvpn.url
Security	security.user_name.user
	security.user_name.admin
	security.user_name.var
	security.user_password
	security.trust_certificates

Item	Configurations
	security.ca_cert
	security.dev_cert
	security.cn_validation
	security.var_enable
	trusted_certificates.url
	trusted_certificates.delete
	server_certificates.url
	server_certificates.delete
	wui.https_enable
	wui.http_enable
Log	syslog.mode
	syslog.server
	syslog.log_level
Autoprovision	auto_provision.custom.sync
	auto_provision.custom.protect
	auto_provision.custom.upload_method
	auto_provision.power_on
	auto_provision.pnp_enable
	auto_provision.dhcp_option.enable
	auto_provision.dhcp_option.list_user_options
	auto_provision.repeat.enable
	auto_provision.repeat.minutes
	auto_provision.weekly.enable
	auto_provision.weekly.dayofweek
	auto_provision.weekly.begin_time
	auto_provision.weekly.end_time
	auto_provision.server.url
	auto_provision.server.username
	auto_provision.server.password
auto_provision.aes_key_16.com	
auto_provision.aes_key_16.mac	

Item	Configurations
	auto_provision.aes_key_in_file
	auto_provision.dhcp_option.option60_value
	auto_provision.reboot_force.enable
	auto_provision.url_wildcard.pn
	zero_touch.enable
	zero_touch.wait_time
	autoprovision.X.name
	autoprovision.X.code
	autoprovision.X.user
	autoprovision.X.password
	autoprovision.X.url
	autoprovision.X.com_aes
	autoprovision.X.mac_aes
SIP	sip.notify_reboot_enable
	sip.escape_characters.enable
	sip.listen_mode
	sip.reserve_characters
	sip.use_23_as_pound
	sip.rfc2543_hold
	account.X.custom_ua
	sip.reg_surge_prevention
	sip.send_response_by_request
	sip.refer_by_header_auto_build
	sip.tcp_port_random_mode
	sip.use_out_bound_in_dialog
	sip.call_park_without_blf
Configurations associated with the password	ldap.password
	phone_setting.phone_lock.unlock_pin
	account.X.hoteling.password
	account.X.xsi.password
	account.X.password

Item	Configurations
	managementserver.connection_request_password
	managementserver.password
DND&Forward	account.X.always_fwd.enable
	account.X.always_fwd.target
	account.X.always_fwd.off_code
	account.X.always_fwd.on_code
	account.X.busy_fwd.enable
	account.X.busy_fwd.target
	account.X.busy_fwd.off_code
	account.X.busy_fwd.on_code
	account.X.timeout_fwd.enable
	account.X.timeout_fwd.target
	account.X.timeout_fwd.timeout
	account.X.timeout_fwd.off_code
	account.X.timeout_fwd.on_code
	account.X.dnd.enable
	account.X.dnd.off_code
	account.X.dnd.on_code
	features.fwd_mode
	features.fwd_diversion_enable
	forward.always.enable
	forward.always.target
	forward.always.on_code
	forward.always.off_code
	forward.busy.enable
	forward.busy.target
	forward.busy.on_code
	forward.busy.off_code
forward.no_answer.enable	
forward.no_answer.target	
forward.no_answer.timeout	

Item	Configurations
	forward.no_answer.on_code
	forward.no_answer.off_code
	forward.international.enable
	features.dnd_mode
	features.dnd.enable
	features.dnd.on_code
	features.dnd.off_code
	features.dnd_refuse_code
Feature access code	account.X.anonymous_call_oncode
	account.X.anonymous_call_offcode
	account.X.anonymous_reject_oncode
	account.X.anonymous_reject_offcode
	features.pickup.direct_pickup_code
	account.X.direct_pickup_code
	features.pickup.group_pickup_code
	account.X.group_pickup_code
	call_waiting.on_code
	call_waiting.off_code
	features.call_park.park_code
	features.call_park.group_park_code
	features.call_park.park_retrieve_code
	account.X.blf_list_code
	account.X.blf_list_barge_in_code
	account.X.blf_list_retrieve_call_parked_code
account.X.shared_line_callpull_code	
voice_mail.number.X	
Access URL of the xml format resoures	custom_mac_cfg.url
	dialplan_dialnow.url
	dialplan_replace_rule.url
	remote_phonebook.data.X.url
	super_search.url

Item	Configurations
files/configuration files	web_item_level.url
	trusted_certificates.url
	server_certificates.url
	local_contact.data.url
	directory_setting.url
	custom_factory_configuration.url
	configuration.url
	custom_softkey_call_failed.url
	custom_softkey_call_in.url
	custom_softkey_connecting.url
	custom_softkey_dialing.url
	custom_softkey_ring_back.url
	custom_softkey_talking.url
	firmware.url
	DNS
dns_cache_a.X.ip	
dns_cache_a.X.ttl	
dns_cache_srv.X.name	
dns_cache_srv.X.port	
dns_cache_srv.X.priority	
dns_cache_srv.X.target	
dns_cache_srv.X.weight	
dns_cache_srv.X.ttl	
dns_cache_naptr.X.name	
dns_cache_naptr.X.flags	
dns_cache_naptr.X.order	
dns_cache_naptr.X.preference	
dns_cache_naptr.X.replace	
dns_cache_naptr.X.service	
dns_cache_naptr.X.ttl	
Configurations	features.relog_offtime

Item	Configurations
requiring a reboot during auto provisioning	features.blf_list_version
	phone_setting.show_code403
	account.X.srv_ttl_timer_enable
	features.show_default_account
	account.X.subscribe_expires_overlap
	account.X.register_expires_overlap
	bw.enable
	features.uc_enable
	features.uc_username
	features.uc_password
	account.X.hoteling.enable
	voice.handfree_send
	voice.handset_send
	voice.headset_send

Appendix G: SIP (Session Initiation Protocol)

This section describes how Yealink IP phones comply with the IETF definition of SIP as described in [RFC 3261](#).

This section contains compliance information in the following:

- [RFC and Internet Draft Support](#)
- [SIP Request](#)
- [SIP Header](#)
- [SIP Responses](#)
- [SIP Session Description Protocol \(SDP\) Usage](#)

RFC and Internet Draft Support

The following RFC's and Internet drafts are supported:

- RFC 1321—The MD5 Message-Digest Algorithm
- RFC 1889—RTP Media control
- RFC 2112—Multipart MIME
- RFC 2327—SDP: Session Description Protocol
- RFC 2387—The MIME Multipart/Related Content-type

- RFC 2543—SIP: Session Initiation Protocol
- RFC 2617—Http Authentication: Basic and Digest access authentication
- RFC 2782—A DNS RR for specifying the location of services (DNS SRV)
- RFC 2806—URLs for Telephone Calls
- RFC 2833—RTP Payload for DTMF Digits, Telephony Tones and Telephony Signals
- RFC 2915—The Naming Authority Pointer (NAPTR) DNS Resource Record
- RFC 2976—The SIP INFO Method
- RFC 3087—Control of Service Context using SIP Request-URI
- RFC 3261—SIP: Session Initiation Protocol (replacement for RFC 2543)
- RFC 3262—Reliability of Provisional Responses in the Session Initiation Protocol (SIP)
- RFC 3263—Session Initiation Protocol (SIP): Locating SIP Servers
- RFC 3264—An Offer/Answer Model with the Session Description Protocol (SDP)
- RFC 3265—Session Initiation Protocol (SIP) - Specific Event Notification
- RFC 3266—Support for IPv6 in Session Description Protocol (SDP)
- RFC 3310—HTTP Digest Authentication Using Authentication and Key Agreement (AKA)
- RFC 3311—The Session Initiation Protocol (SIP) UPDATE Method
- RFC 3312—Integration of Resource Management and SIP
- RFC 3313—Private SIP Extensions for Media Authorization
- RFC 3323—A Privacy Mechanism for the Session Initiation Protocol (SIP)
- RFC 3324—Requirements for Network Asserted Identity
- RFC 3325—SIP Asserted Identity
- RFC 3326—The Reason Header Field for the Session Initiation Protocol (SIP)
- RFC 3361—DHCP-for-IPv4 Option for SIP Servers
- RFC 3372—SIP for Telephones (SIP-T): Context and Architectures
- RFC 3398—ISUP to SIP Mapping
- RFC 3420—Internet Media Type message/sipfrag
- RFC 3428—Session Initiation Protocol (SIP) Extension for Instant Messaging
- RFC 3455—Private Header (P-Header) Extensions to the SIP for the 3GPP
- RFC 3486—Compressing the Session Initiation Protocol (SIP)
- RFC 3489—STUN - Simple Traversal of User Datagram Protocol (UDP) Through Network Address Translators (NATs)
- RFC 3515—The Session Initiation Protocol (SIP) Refer Method
- RFC 3550—RTP: Transport Protocol for Real-Time Applications
- RFC 3555—MIME Type Registration of RTP Payload Formats
- RFC 3581—An Extension to the SIP for Symmetric Response Routing
- RFC 3608—SIP Extension Header Field for Service Route Discovery During Registration

- RFC 3611—RTP Control Protocol Extended Reports (RTCP XR)
- RFC 3665—Session Initiation Protocol (SIP) Basic Call Flow Examples
- RFC 3666—SIP Public Switched Telephone Network (PSTN) Call Flows.
- RFC 3680—SIP Event Package for Registrations
- RFC 3702—Authentication, Authorization, and Accounting Requirements for the SIP
- RFC 3711—The Secure Real-time Transport Protocol (SRTP)
- RFC 3725—Best Current Practices for Third Party Call Control (3pcc) in the Session Initiation Protocol (SIP)
- RFC 3842—A Message Summary and Message Waiting Indication Event Package for the Session Initiation Protocol (SIP)
- RFC 3856—A Presence Event Package for Session Initiation Protocol (SIP)
- RFC 3863—Presence Information Data Format
- RFC 3890—A Transport Independent Bandwidth Modifier for the SDP
- RFC 3891—The Session Initiation Protocol (SIP) “Replaces” Header
- RFC 3892—The Session Initiation Protocol (SIP) Referred-By Mechanism
- RFC 3959—The Early Session Disposition Type for SIP
- RFC 3960—Early Media and Ringing Tone Generation in SIP
- RFC 3966—The tel URI for telephone number
- RFC 3968—IANA Registry for SIP Header Field
- RFC 3969—IANA Registry for SIP URI
- RFC 4028—Session Timers in the Session Initiation Protocol (SIP)
- RFC 4083—3GPP Release 5 Requirements on SIP
- RFC 4235—An INVITE-Initiated Dialog Event Package for the Session Initiation Protocol (SIP)
- RFC 4244—An Extension to the SIP for Request History Information
- RFC 4317—Session Description Protocol (SDP) Offer/Answer Examples
- RFC 4353—A Framework for Conferencing with the SIP
- RFC 4458—SIP URIs for Applications such as Voicemail and Interactive Voice Response (IVR)
- RFC 4475—Session Initiation Protocol (SIP) Torture
- RFC 4485—Guidelines for Authors of Extensions to the SIP
- RFC 4504—SIP Telephony Device Requirements and Configuration
- RFC 4566—SDP: Session Description Protocol.
- RFC 4568—Session Description Protocol (SDP) Security Descriptions for Media Streams
- RFC 4575—A SIP Event Package for Conference State
- RFC 4579—SIP Call Control - Conferencing for User Agents
- RFC 4583—Session Description Protocol (SDP) Format for Binary Floor Control

Protocol (BFCP) Streams

- RFC 4662—A SIP Event Notification Extension for Resource Lists
- RFC 4730—Event Package for KPML
- RFC 5009—P-Early-Media Header
- RFC 5079—Rejecting Anonymous Requests in SIP
- RFC 5359—Session Initiation Protocol Service Examples
- RFC 5589—Session Initiation Protocol (SIP) Call Control – Transfer
- RFC 5630—The Use of the SIPS URI Scheme in SIP
- RFC 5806—Diversion Indication in SIP
- RFC 5954—Essential Correction for IPv6 ABNF and URI Comparison in RFC 3261
- RFC 6026—Correct Transaction Handling for 2xx Responses to SIP INVITE Requests
- RFC 6141—Re-INVITE and Target-Refresh Request Handling in SIP
- draft-ietf-sip-cc-transfer-05.txt—SIP Call Control - Transfer
- draft-anil-sipping-bla-02.txt—Implementing Bridged Line Appearances (BLA) Using Session Initiation Protocol (SIP)
- draft-anil-sipping-bla-03.txt—Implementing Bridged Line Appearances (BLA) Using Session Initiation Protocol (SIP)
- draft-ietf-sip-privacy-00.txt—SIP Extensions for Caller Identity and Privacy, November
- draft-ietf-sip-privacy-04.txt—SIP Extensions for Network-Asserted Caller Identity and Privacy within Trusted Networks
- draft-levy-sip-diversion-08.txt—Diversion Indication in SIP
- draft-ietf-sipping-cc-conferencing-03.txt—SIP Call Control - Conferencing for User Agents
- draft-ietf-sipping-cc-conferencing-05.txt—Connection Reuse in the Session Initiation Protocol (SIP)
- draft-ietf-sipping-rtcp-summary-02.txt—Session Initiation Protocol Package for Voice Quality Reporting Event
- draft-ietf-sip-connect-reuse-06.txt—Connection Reuse in the Session Initiation Protocol (SIP)
- draft-ietf-bliss-shared-appearances-15.txt—Shared Appearances of a Session Initiation Protocol (SIP) Address of Record (AOR)

To find the applicable Request for Comments (RFC) document, go to <http://www.ietf.org/rfc.html> and enter the RFC number.

SIP Request

The following SIP request messages are supported:

Method	Supported	Notes
REGISTER	Yes	
INVITE	Yes	Yealink IP phones support mid-call changes such as placing a call on hold as signaled by a new INVITE that contains an existing Call-ID.
ACK	Yes	
CANCEL	Yes	
BYE	Yes	
OPTIONS	Yes	
SUBSCRIBE	Yes	
NOTIFY	Yes	
REFER	Yes	
PRACK	Yes	
INFO	Yes	
MESSAGE	Yes	
UPDATE	Yes	
PUBLISH	Yes	

SIP Header

The following SIP request headers are supported:

Note In the following table, a “Yes” in the Supported column means the header is sent and properly parsed.

Method	Supported	Notes
Accept	Yes	
Alert-Info	Yes	
Allow	Yes	
Allow-Events	Yes	
Authorization	Yes	

Method	Supported	Notes
Call-ID	Yes	
Call-Info	Yes	
Contact	Yes	
Content-Length	Yes	
Content-Type	Yes	
CSeq	Yes	
Diversion	Yes	
History-Info	Yes	
Event	Yes	
Expires	Yes	
From	Yes	
Max-Forwards	Yes	
Min-SE	Yes	
P-Asserted-Identity	Yes	
P-Preferred-Identity	Yes	
Proxy-Authenticate	Yes	
Proxy-Authorization	Yes	
RAck	Yes	
Record-Route	Yes	
Refer-To	Yes	
Referred-By	Yes	
Remote-Party-ID	Yes	
Replaces	Yes	
Require	Yes	
Route	Yes	
RSeq	Yes	
Session-Expires	Yes	
Subscription-State	Yes	
Supported	Yes	
To	Yes	

Method	Supported	Notes
User-Agent	Yes	
Via	Yes	

SIP Responses

The following SIP responses are supported:

Note In the following table, a “Yes” in the Supported column means the header is sent and properly parsed. The phone may not actually generate the response.

1xx Response—Information Responses

1xx Response	Supported	Notes
100 Trying	Yes	
180 Ringing	Yes	
181 Call Is Being Forwarded	Yes	
183 Session Progress	Yes	

2xx Response—Successful Responses

2xx Response	Supported	Notes
200 OK	Yes	
202 Accepted	Yes	In REFER transfer.

3xx Response—Redirection Responses

3xx Response	Supported	Notes
300 Multiple Choices	Yes	
301 Moved Permanently	Yes	
302 Moved Temporarily	Yes	

4xx Response—Request Failure Responses

4xx Response	Supported	Notes
--------------	-----------	-------

4xx Response	Supported	Notes
400 Bad Request	Yes	
401 Unauthorized	Yes	
402 Payment Required	Yes	
403 Forbidden	Yes	
404 Not Found	Yes	
405 Method Not Allowed	Yes	
406 Not Acceptable	No	
407 Proxy Authentication Required	Yes	
408 Request Timeout	Yes	
409 Conflict	No	
410 Gone	No	
411 Length Required	No	
413 Request Entity Too Large	No	
414 Request-URI Too Long	Yes	
415 Unsupported Media Type	Yes	
416 Unsupported URI Scheme	No	
420 Bad Extension	No	
421 Extension Required	No	
423 Interval Too Brief	Yes	
480 Temporarily Unavailable	Yes	
481 Call/Transaction Does Not Exist	Yes	
482 Loop Detected	Yes	
483 Too Many Hops	No	
484 Address Incomplete	Yes	
485 Ambiguous	No	
486 Busy Here	Yes	
487 Request Terminated	Yes	
488 Not Acceptable Here	Yes	
491 Request Pending	No	

4xx Response	Supported	Notes
493 Undecipherable	No	

5xx Response—Server Failure Responses

5xx Response	Supported	Notes
500 Internal Server Error	Yes	
501 Not Implemented	Yes	
502 Bad Gateway	No	
503 Service Unavailable	No	
504 Gateway Timeout	No	
505 Version Not Supported	No	

6xx Response—Global Responses

6xx Response	Supported	Notes
600 Busy Everywhere	Yes	
603 Decline	Yes	
604 Does Not Exist Anywhere	No	
606 Not Acceptable	No	

SIP Session Description Protocol (SDP) Usage

SDP Headers	Supported
v—Protocol version	Yes
o—Owner/creator and session identifier	Yes
a—Media attribute	Yes
c—Connection information	Yes
m—Media name and transport address	Yes
s—Session name	Yes
t—Active time	Yes

Appendix H: SIP Call Flows

SIP uses six request methods:

- INVITE—Indicates a user is being invited to participate in a call session.
- ACK—Confirms that the client has received a final response to an INVITE request.
- BYE—Terminates a call and can be sent by either the caller or the callee.
- CANCEL—Cancels any pending searches but does not terminate a call that has already been accepted.
- OPTIONS—Queries the capabilities of servers.
- REGISTER—Registers the address listed in the To header field with a SIP server.

The following types of responses are used by SIP and generated by the IP phone or the SIP server:

- SIP 1xx—Informational Responses
- SIP 2xx—Successful Responses
- SIP 3xx—Redirection Responses
- SIP 4xx—Client Failure Responses
- SIP 5xx—Server Failure Responses
- SIP 6xx—Global Failure Responses

Successful Call Setup and Disconnect

The following figure illustrates the scenario of a successful call. In this scenario, the two end users are User A and User B. User A and User B are located at Yealink SIP IP phones.

The call flow scenario is as follows:

1. User A calls User B.
2. User B answers the call.

3. User B hangs up.

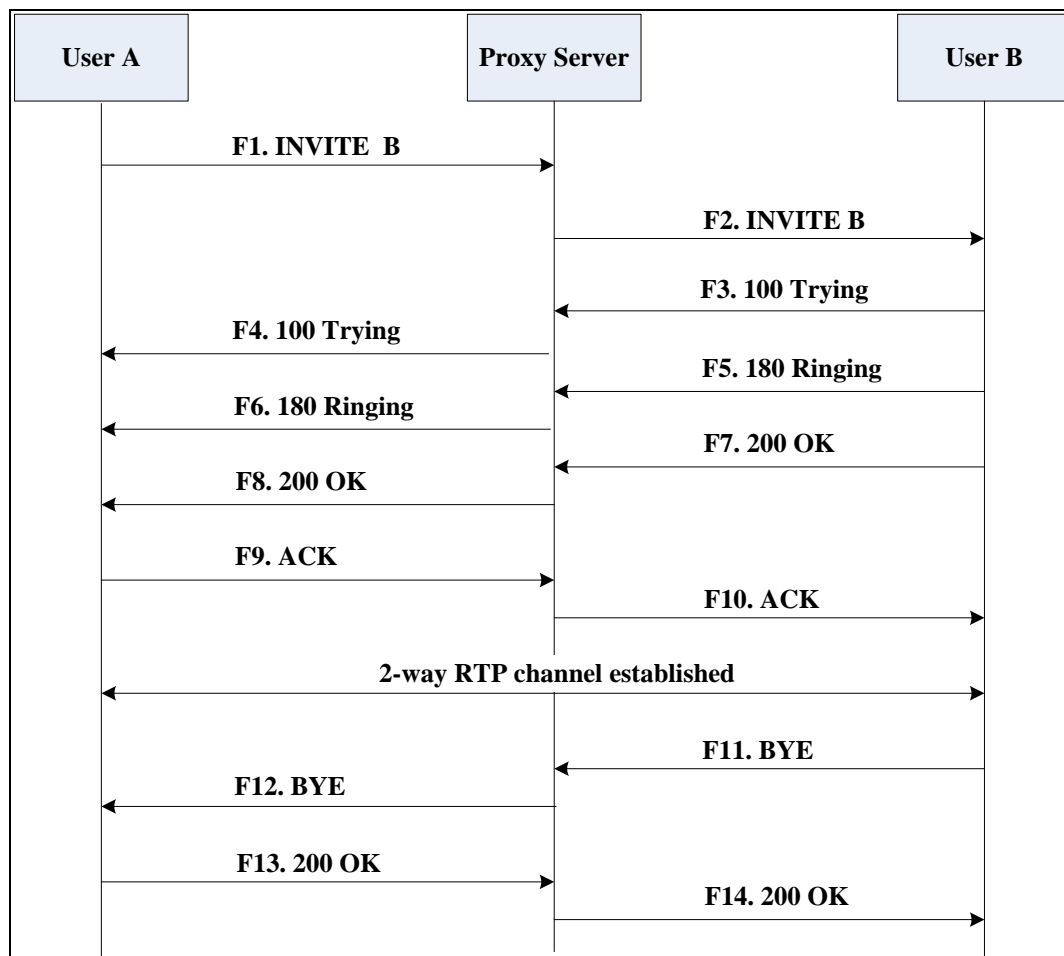

Step	Action	Description
F1	INVITE—User A to Proxy Server	<p>User A sends a SIP INVITE message to a proxy server. The INVITE request is an invitation to User B to participate in a call session.</p> <p>In the INVITE request:</p> <ul style="list-style-type: none"> The IP address of User B is inserted in the Request-URI field. User A is identified as the call session initiator in the From field. A unique numeric identifier is assigned to the call and is inserted in the Call-ID field. The transaction number within a single call leg is identified in the

Step	Action	Description
		<p>CSeq field.</p> <ul style="list-style-type: none"> The media capability User A is ready to receive is specified. The port on which User B is prepared to receive the RTP data is specified.
F2	INVITE—Proxy Server to User B	The proxy server maps the SIP URI in the To field to User B. The proxy server sends the INVITE message to User B.
F3	100 Trying—User B to Proxy Server	User B sends a SIP 100 Trying response to the proxy server. The 100 Trying response indicates that the INVITE request has been received by User B.
F4	100 Trying—Proxy Server to User A	The proxy server forwards the SIP 100 Trying to User A to indicate that the INVITE request has been received by User B.
F5	180 Ringing—User B to Proxy Server	User B sends a SIP 180 Ringing response to the proxy server. The 180 Ringing response indicates that the User B is being alerted.
F6	180 Ringing—Proxy Server to User A	The proxy server forwards the 180 Ringing response to User A. User A hears the ring-back tone indicating that User B is being alerted.
F7	200 OK— User B to Proxy Server	User B sends a SIP 200 OK response to the proxy server. The 200 OK response notifies User A that the connection has been made.
F8	200OK—Proxy Server to User A	The proxy server forwards the 200 OK message to User A. The 200 OK response notifies User A that the connection has been made.
F9	ACK—User A to Proxy Server	User A sends a SIP ACK to the proxy server. The ACK confirms that User A has received the 200 OK response. The call session is now active.
F10	ACK—Proxy Server to User B	The proxy server sends the SIP ACK to

Step	Action	Description
		User B. The ACK confirms that the proxy server has received the 200 OK response. The call session is now active.
F11	BYE—User B to Proxy Server	User B terminates the call session by sending a SIP BYE request to the proxy server. The BYE request indicates that User B wants to release the call.
F12	BYE—Proxy Server to User A	The proxy server forwards the SIP BYE request to User A to notify that User B wants to release the call.
F13	200 OK—User A to Proxy Server	User A sends a SIP 200 OK response to the proxy server. The 200 OK response indicates that User A has received the BYE request. The call session is now terminated.
F14	200 OK—Proxy Server to User B	The proxy server forwards the SIP 200 OK response to User B to indicate that User A has received the BYE request. The call session is now terminated.

Unsuccessful Call Setup—Called User is Busy

The following figure illustrates the scenario of an unsuccessful call caused by the called user's being busy. In this scenario, the two end users are User A and User B. User A and User B are located at Yealink SIP IP phones.

The call flow scenario is as follows:

1. User A calls User B.
2. User B is busy on the IP phone and unable or unwilling to take another call.

The call cannot be set up successfully.

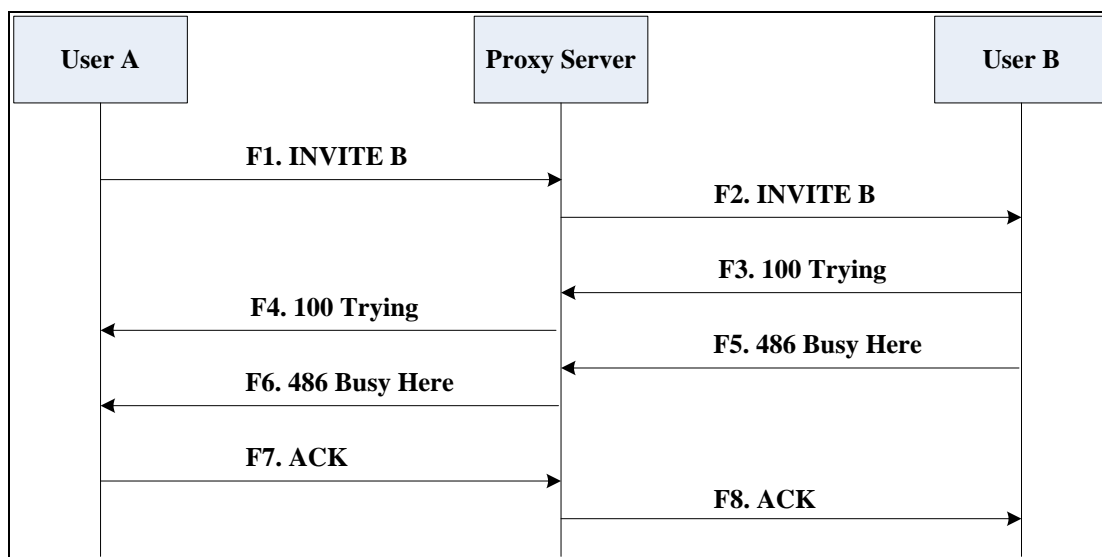

Step	Action	Description
F1	INVITE—User A to Proxy Server	<p>User A sends the INVITE message to a proxy server. The INVITE request is an invitation to User B to participate in a call session.</p> <p>In the INVITE request:</p> <ul style="list-style-type: none"> The IP address of User B is inserted in the Request-URI field. User A is identified as the call session initiator in the From field. A unique numeric identifier is assigned to the call and is inserted in the Call-ID field. The transaction number within a single call leg is identified in the CSeq field. The media capability User A is ready to receive is specified. The port on which User B is prepared to receive the RTP data is specified.
F2	INVITE—Proxy Server to User B	The proxy server maps the SIP URI in the To field to User B. Proxy server forwards the INVITE message to User B.
F3	100 Trying—User B to Proxy	User B sends a SIP 100 Trying response

Step	Action	Description
	Server	to the proxy server. The 100 Trying response indicates that the INVITE request has been received by User B.
F4	100 Trying—Proxy Server to User A	The proxy server forwards the SIP 100 Trying to User A to indicate that the INVITE request has already been received.
F5	486 Busy Here—User B to Proxy Server	User B sends a SIP 486 Busy Here response to the proxy server. The 486 Busy Here response is a client error response indicating that User B is successfully connected but User B is busy on the IP phone and unable or unwilling to take the call.
F6	486 Busy Here—Proxy Server to User A	The proxy server forwards the 486 Busy Here response to notify User A that User B is busy.
F7	ACK—User A to Proxy Server	User A sends a SIP ACK to the proxy server. The SIP ACK message indicates that User A has received the 486 Busy Here message.
F8	ACK—Proxy Server to User B	The proxy server forwards the SIP ACK to User B to indicate that the 486 Busy Here message has already been received.

Unsuccessful Call Setup—Called User Does Not Answer

The following figure illustrates the scenario of an unsuccessful call caused by the called user's no answering. In this scenario, the two end users are User A and User B. User A and User B are located at Yealink SIP IP phones.

The call flow scenario is as follows:

1. User A calls User B.
2. User B does not answer the call.
3. User A hangs up.

The call cannot be set up successfully.

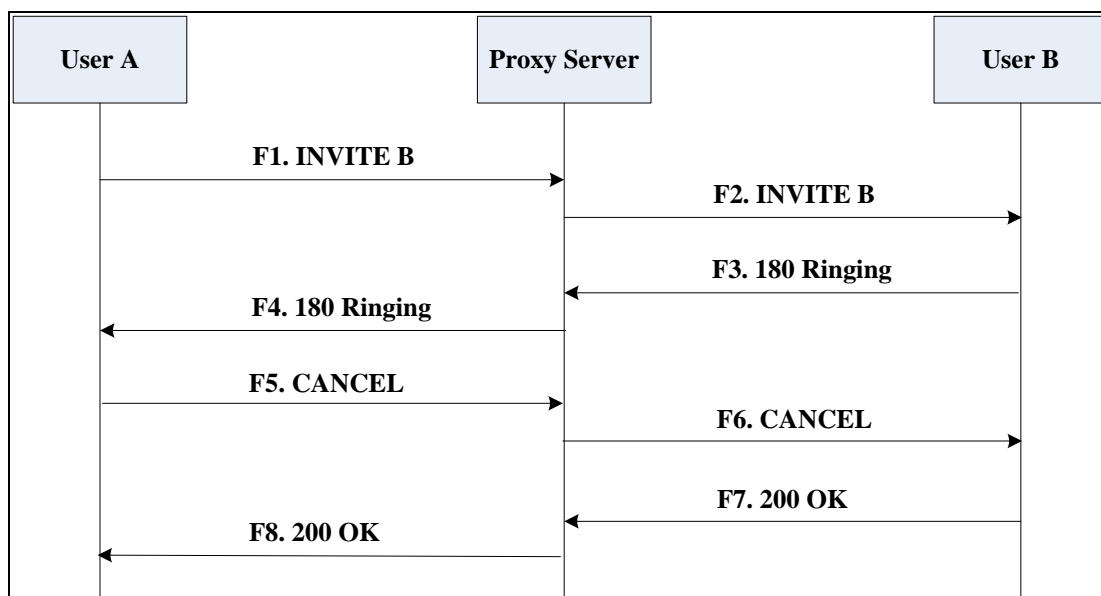

Step	Action	Description
F1	INVITE—User A to Proxy Server	<p>User A sends an INVITE message to a proxy server. The INVITE request is an invitation to User B to participate in a call session.</p> <p>In the INVITE request:</p> <ul style="list-style-type: none"> • The IP address of User B is inserted in the Request-URI field. • User A is identified as the call session initiator in the From field. • A unique numeric identifier is assigned to the call and is inserted in the Call-ID field. • The transaction number within a single call leg is identified in the CSeq field. • The media capability User A is ready to receive is specified.

Step	Action	Description
		<ul style="list-style-type: none"> The port on which User B is prepared to receive the RTP data is specified.
F2	INVITE—Proxy Server to User B	The proxy server maps the SIP URI in the To field to User B. Proxy server forwards the INVITE message to User B.
F3	180 Ringing—User B to Proxy Server	User B sends a SIP 180 Ringing response to the proxy server. The 180 Ringing response indicates that the user is being alerted.
F4	180 Ringing—Proxy Server to User A	The proxy server forwards the 180 Ringing response to User A. User A hears the ring-back tone indicating that User B is being alerted.
F5	CANCEL—User A to Proxy Server	User A sends a SIP CANCEL request to the proxy server after not receiving an appropriate response within the time allocated in the INVITE request. The SIP CANCEL request indicates that User A wants to disconnect the call.
F6	CANCEL—Proxy Server to User B	The proxy server forwards the SIP CANCEL request to notify User B that User A wants to disconnect the call.
F7	200 OK—User B to Proxy Server	User B sends a SIP 200 OK response to the proxy server. The SIP 200 OK response indicates that User B has received the CANCEL request.
F8	200 OK—Proxy Server to User A	The proxy server forwards the SIP 200 OK response to notify User A that the CANCEL request has been processed successfully.

Successful Call Setup and Call Hold

The following figure illustrates a successful call setup and call hold. In this scenario, the two end users are User A and User B. User A and User B are located at Yealink SIP IP phones.

The call flow scenario is as follows:

1. User A calls User B.
2. User B answers the call.
3. User A places User B on hold.

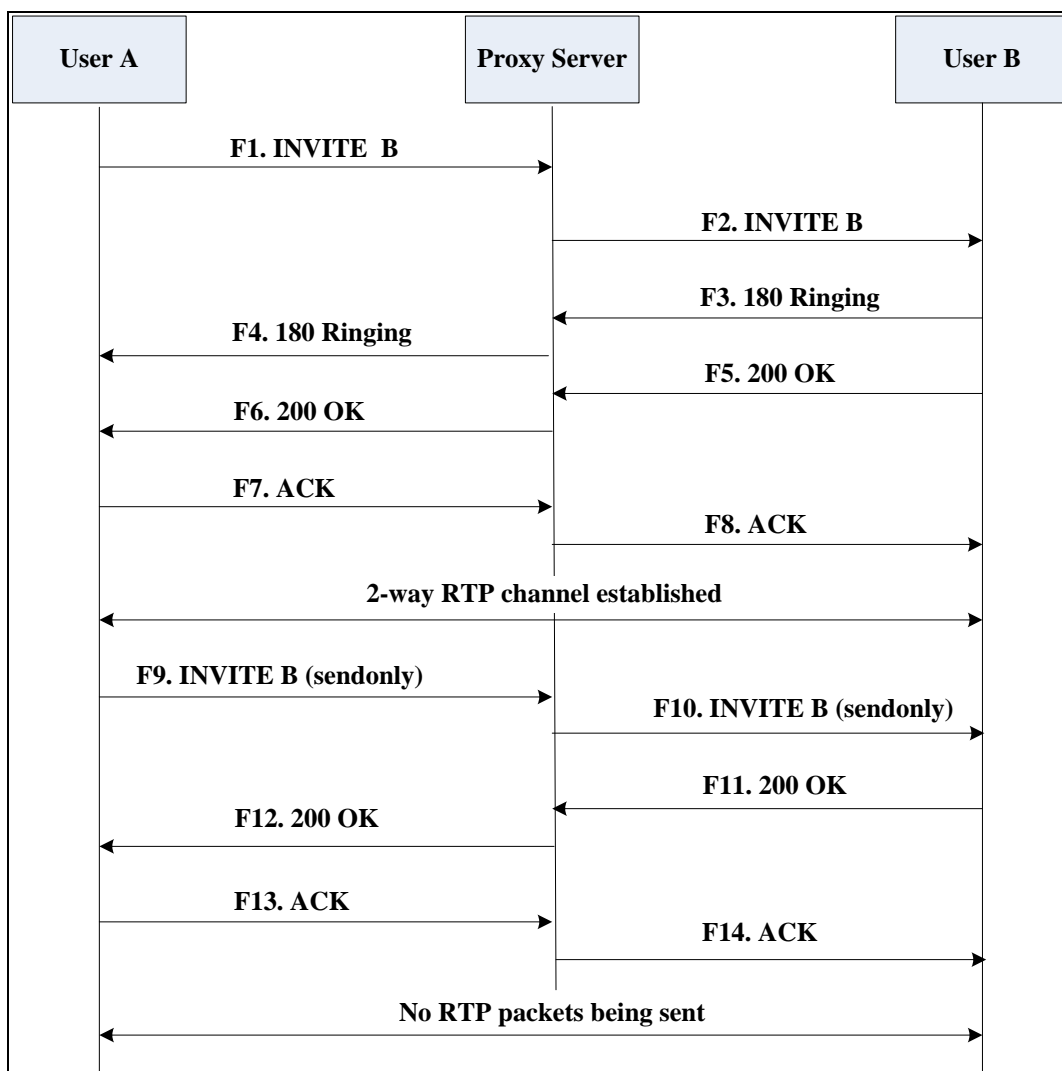

Step	Action	Description
F1	INVITE—User A to Proxy Server	<p>User A sends an INVITE message to a proxy server. The INVITE request is an invitation to User B to participate in a call session.</p> <p>In the INVITE request:</p> <ul style="list-style-type: none"> • The IP address of User B is inserted in the Request-URI field. • User A is identified as the call session initiator in the From field. • A unique numeric identifier is assigned to the call and is inserted in the Call-ID field. • The transaction number within a single call leg is identified in the CSeq field. • The media capability User A is ready to receive is specified. • The port on which User B is prepared to receive the RTP data is specified.
F2	INVITE—Proxy Server to User B	The proxy server maps the SIP URI in the To field to User B. The proxy server sends the INVITE message to User B.
F3	180 Ringing—User B to Proxy Server	User B sends a SIP 180 Ringing response to the proxy server. The 180 Ringing response indicates that the user is being alerted.
F4	180 Ringing—Proxy Server to User A	The proxy server forwards the 180 Ringing response to User A. User A hears the ring-back tone indicating that User B is being alerted.
F5	200 OK—User B to Proxy Server	User B sends a SIP 200 OK response to the proxy server. The 200 OK response notifies the proxy server that the connection has been made.
F6	200 OK—Proxy Server to User A	The proxy server forwards the 200 OK message to User A. The 200 OK response notifies User A that the connection has been made.

Step	Action	Description
F7	ACK—User A to Proxy Server	User A sends a SIP ACK to the proxy server. The ACK confirms that User A has received the 200 OK response. The call session is now active.
F8	ACK—Proxy Server to User B	The proxy server sends the SIP ACK to User B. The ACK confirms that the proxy server has received the 200 OK response. The call session is now active.
F9	INVITE—User A to Proxy Server	User A sends a mid-call INVITE request to the proxy server with new SDP session parameters, which are used to place the call on hold.
F10	INVITE—Proxy Server to User B	The proxy server forwards the mid-call INVITE message to User B.
F11	200 OK—User B to Proxy Server	User B sends a SIP 200 OK response to the proxy server. The 200 OK response notifies User A that the INVITE is successfully processed.
F12	200 OK—Proxy Server to User A	The proxy server forwards the 200 OK response to User A. The 200 OK response notifies User B is successfully placed on hold.
F13	ACK—User A to Proxy Server	User A sends an ACK message to the proxy server. The ACK confirms that User A has received the 200 OK response. The call session is now temporarily inactive. No RTP packets are being sent.
F14	ACK—Proxy Server to User B	The proxy server sends the ACK message to User B. The ACK confirms that the proxy server has received the 200 OK response.

Successful Call Setup and Call Waiting

The following figure illustrates a successful call between Yealink SIP IP phones in which two parties are in a call, one of the participants receives and answers an incoming call from a third party. In this call flow scenario, the end users are User A, User B, and User C. They are all using Yealink SIP IP phones, which are connected via an IP network.

The call flow scenario is as follows:

1. User A calls User B.
2. User B answers the call.
3. User C calls User B.
4. User B accepts the call from User C.

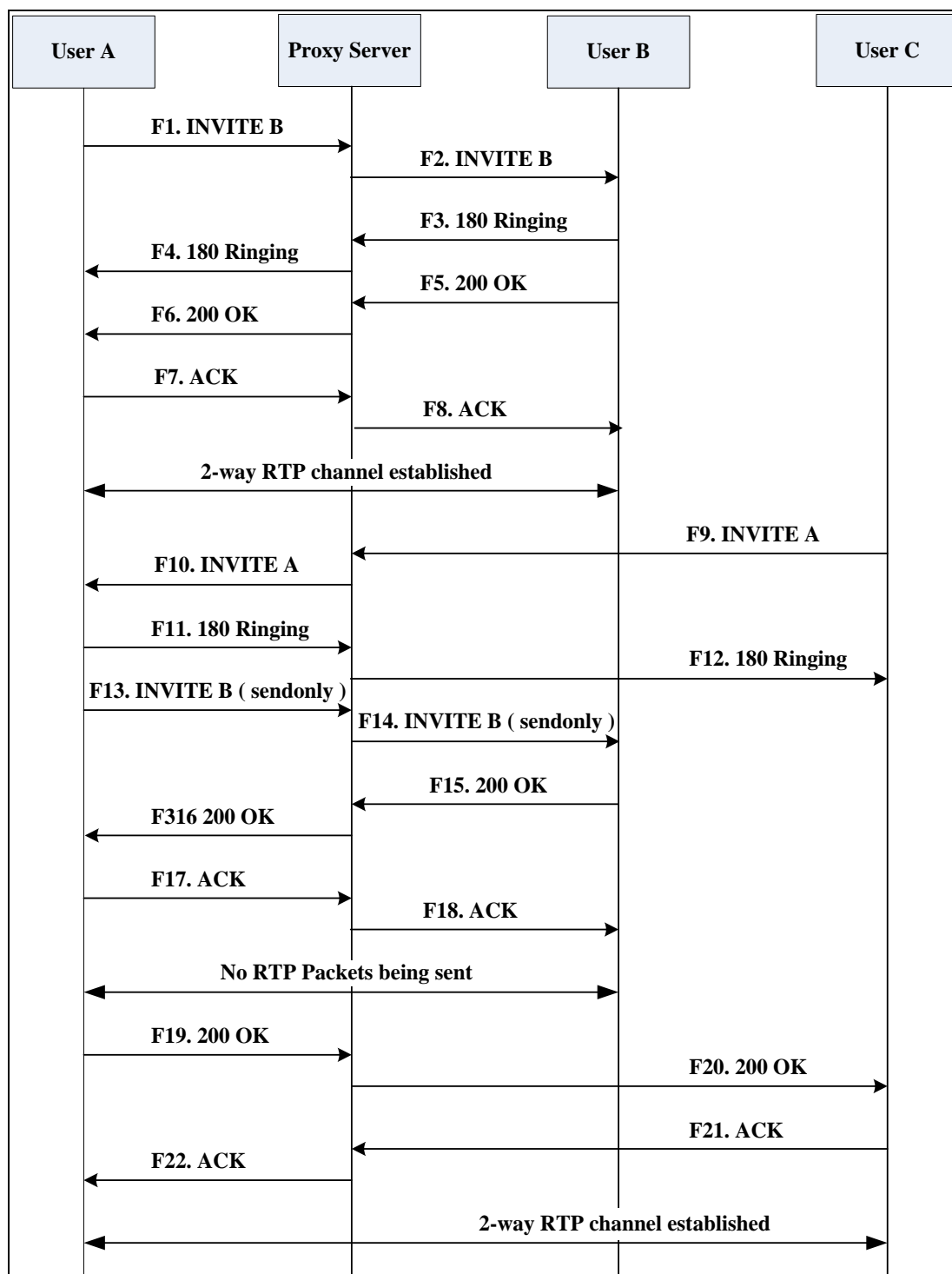

Step	Action	Description
F1	INVITE—User A to Proxy Server	<p>User A sends an INVITE message to a proxy server. The INVITE request is an invitation to User B to participate in a call session.</p> <p>In the INVITE request:</p> <ul style="list-style-type: none"> • The IP address of User B is inserted in the Request-URI field. • User A is identified as the call session initiator in the From field. • A unique numeric identifier is assigned to the call and is inserted in the Call-ID field. • The transaction number within a single call leg is identified in the CSeq field. • The media capability User A is ready to receive is specified. • The port on which User B is prepared to receive the RTP data is specified.
F2	INVITE—Proxy Server to User B	The proxy server maps the SIP URI in the To field to User B. The proxy server sends the INVITE message to User B.
F3	180 Ringing—User B to Proxy Server	User B sends a SIP 180 Ringing response to the proxy server. The 180 Ringing response indicates that the user is being alerted.
F4	180 Ringing—Proxy Server to User A	The proxy server forwards the 180 Ringing response to User A. User A hears the ring-back tone indicating that User B is being alerted.
F5	200 OK—User B to Proxy Server	User B sends a SIP 200 OK response to the proxy server. The 200 OK response notifies proxy server that the connection has been made.
F6	200 OK—Proxy Server to User A	The proxy server forwards the 200 OK message to User A. The 200 OK response notifies User A that the connection has been made.

Step	Action	Description
F7	ACK—User A to Proxy Server	User A sends a SIP ACK to the proxy server, The ACK confirms that User A has received the 200 OK response. The call session is now active.
F8	ACK—Proxy Server to User B	The proxy server sends the SIP ACK to User B. The ACK confirms that the proxy server has received the 200 OK response. The call session is now active.
F9	INVITE—User C to Proxy Server	<p>User C sends a SIP INVITE message to the proxy server. The INVITE request is an invitation to User A to participate in a call session.</p> <p>In the INVITE request:</p> <ul style="list-style-type: none"> • The IP address of User A is inserted in the Request-URI field. • User C is identified as the call session initiator in the From field. • A unique numeric identifier is assigned to the call and is inserted in the Call-ID field. • The transaction number within a single call leg is identified in the CSeq field. • The media capability User C is ready to receive is specified. • The port on which User A is prepared to receive the RTP data is specified.
F10	INVITE—Proxy Server to User A	The proxy server maps the SIP URI in the To field to User A. The proxy server sends the INVITE message to User A.
F11	180 Ringing—User A to Proxy Server	User A sends a SIP 180 Ringing response to the proxy server. The 180 Ringing response indicates that the user is being alerted.
F12	180 Ringing—Proxy Server to User C	The proxy server forwards the 180 Ringing response to User C. User C hears the ring-back tone indicating that User A is being alerted.

Step	Action	Description
F13	INVITE—User A to Proxy Server	User A sends a mid-call INVITE request to the proxy server with new SDP session parameters, which are used to place the call on hold.
F14	INVITE—Proxy Server to User B	The proxy server forwards the mid-call INVITE message to User B.
F15	200 OK—User B to Proxy Server	User B sends a 200 OK to the proxy server. The 200 OK response indicates that the INVITE was successfully processed.
F16	200 OK—Proxy Server to User A	The proxy server forwards the 200 OK response to User A. The 200 OK response notifies User B is successfully placed on hold.
F17	ACK—User A to Proxy Server	User A sends an ACK message to the proxy server. The ACK confirms that User A has received the 200 OK response. The call session is now temporarily inactive. No RTP packets are being sent.
F18	ACK—Proxy Server to User B	The proxy server sends the ACK message to User B. The ACK confirms that the proxy server has received the 200 OK response.
F19	200 OK—User A to Proxy Server	User A sends a 200 OK response to the proxy server. The 200 OK response notifies that the connection has been made.
F20	200 OK—Proxy Server User C	The proxy server forwards the 200 OK message to User C.
F21	ACK—User C to Proxy Server	User C sends a SIP ACK to the proxy server. The ACK confirms that User C has received the 200 OK response. The call session is now active.
F22	ACK—Proxy Server to User A	The proxy server forwards the SIP ACK to User A to confirm that User C has received the 200 OK response.

Call Transfer without Consultation

The following figure illustrates a successful call between Yealink SIP IP phones in which two parties are in a call and then one of the parties transfers the call to a third party without consultation. This is called a blind transfer. In this call flow scenario, the end users are User A, User B, and User C. They are all using Yealink SIP IP phones, which are connected via an IP network.

The call flow scenario is as follows:

1. User A calls User B.
2. User B answers the call.
3. User B transfers the call to User C.
4. User C answers the call.

Call is established between User A and User C.

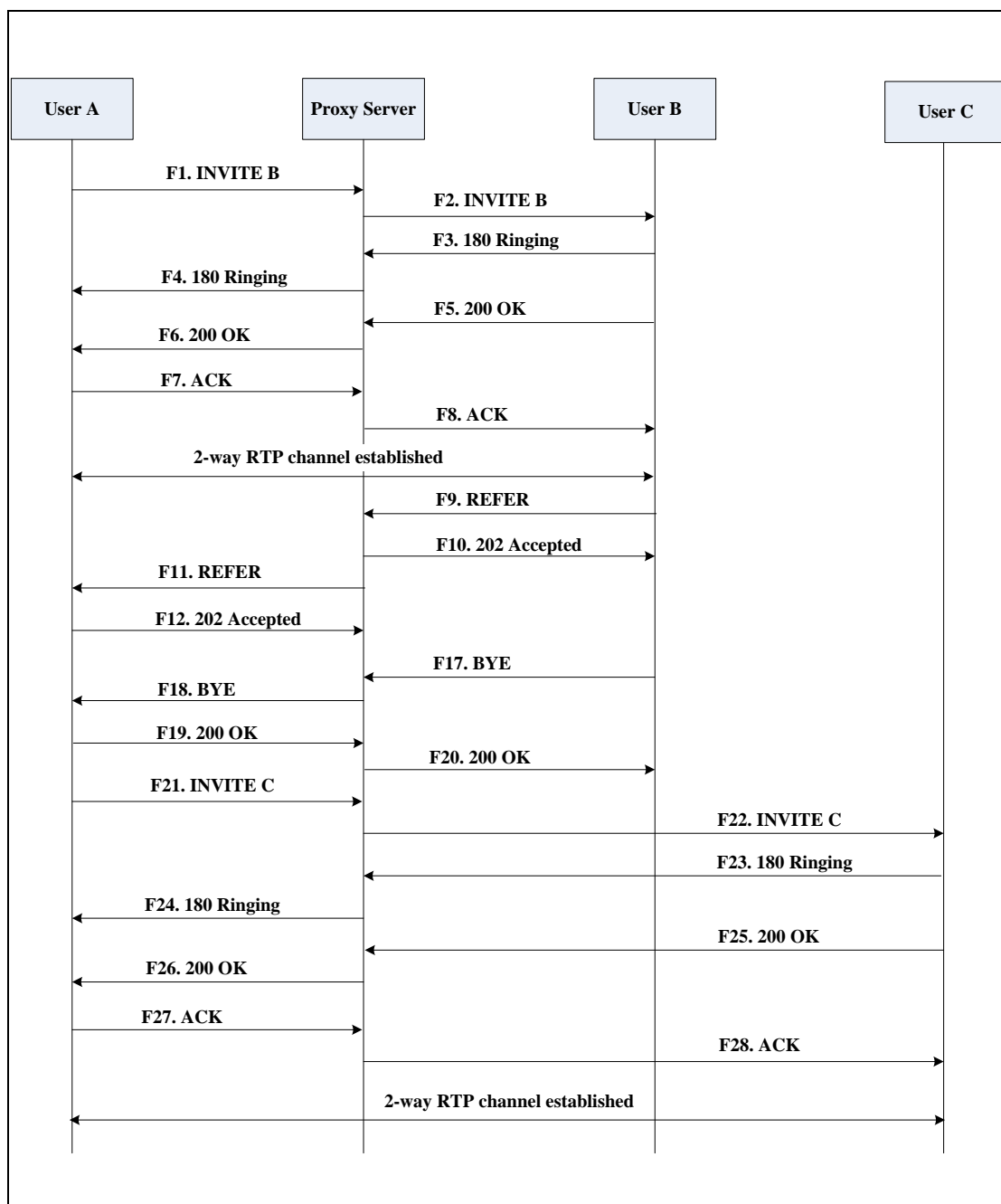

Step	Action	Description
F1	INVITE—User A to Proxy Server	<p>User A sends an INVITE message to the proxy server. The INVITE request is an invitation to User B to participate in a call session.</p> <p>In the INVITE request:</p> <ul style="list-style-type: none"> • The IP address of User B is inserted in the Request-URI field. • User A is identified as the call session initiator in the From field. • A unique numeric identifier is assigned to the call and is inserted in the Call-ID field. • The transaction number within a single call leg is identified in the CSeq field. • The media capability User A is ready to receive is specified. • The port on which User B is prepared to receive the RTP data is specified.
F2	INVITE—Proxy Server to User B	The proxy server maps the SIP URI in the To field to User B. The proxy server sends the INVITE message to User B.
F3	180 Ringing—User B to Proxy server	User B sends a SIP 180 Ringing response to the proxy server. The 180 Ringing response indicates that the user is being alerted.
F4	180 Ringing—Proxy Server to User A	The proxy server forwards the 180 Ringing response to User A. User A hears the ring-back tone indicating that User B is being alerted.
F5	200 OK—User B to Proxy Server	User B sends a SIP 200 OK response to the proxy server. The 200 OK response notifies User A that the connection has been made.
F6	200 OK—Proxy Server to User A	The proxy server forwards the 200 OK message to User A. The 200 OK response notifies User A that the connection has been made.

Step	Action	Description
F7	ACK—User A to Proxy Server	User A sends a SIP ACK to the proxy server, The ACK confirms that User A has received the 200 OK response. The call session is now active.
F8	ACK—Proxy Server to User B	The proxy server sends the SIP ACK to User B. The ACK confirms that the proxy server has received the 200 OK response. The call session is now active.
F9	REFER—User B to Proxy Server	User B sends a REFER message to the proxy server. User B performs a blind transfer of User A to User C.
F10	202 Accepted—Proxy Server to User B	The proxy server sends a SIP 202 Accept response to User B. The 202 Accepted response notifies User B that the proxy server has received the REFER message.
F11	REFER—Proxy Server to User A	The proxy server forwards the REFER message to User A.
F12	202 Accepted—User A to Proxy Server	User A sends a SIP 202 Accept response to the proxy server. The 202 Accepted response indicates that User A accepts the transfer.
F13	BYE—User B to Proxy Server	User B terminates the call session by sending a SIP BYE request to the proxy server. The BYE request indicates that User B wants to release the call.
F14	BYE—Proxy Server to User A	The proxy server forwards the BYE request to User A.
F15	200OK—User A to Proxy Server	User A sends a SIP 200 OK response to the proxy server. The 200 OK response confirms that User A has received the BYE request.
F16	200OK—Proxy Server to User B	The proxy server forwards the SIP 200 OK response to User B.
F17	INVITE—User A to Proxy Server	User A sends a SIP INVITE request to the proxy server. In the INVITE request, a unique Call-ID is generated and the Contact-URI field indicates that User A

Step	Action	Description
		requests the call.
F18	INVITE—Proxy Server to User C	The proxy server maps the SIP URI in the To field to User C.
F19	180 Ringing—User C to Proxy Server	User C sends a SIP 180 Ringing response to the proxy server. The 180 Ringing response indicates that the user is being alerted.
F20	180 Ringing—Proxy Server to User A	The proxy server forwards the 180 Ringing response to User A. User A hears the ring-back tone indicating that User C is being alerted
F21	200OK—User C to Proxy Server	User C sends a SIP 200 OK response to the proxy server. The 200 OK response notifies the proxy server that the connection has been made.
F22	200OK—Proxy Server to User A	The proxy server forwards the SIP 200 OK response to User A.
F23	ACK— User A to Proxy Server	User A sends a SIP ACK to the proxy server. The ACK confirms that User A has received the 200 OK response. The call session is now active.
F24	ACK—Proxy Server to User C	The proxy server forwards the ACK message to User C. The ACK confirms that User A has received the 200 OK response. The call session is now active.

Call Transfer with Consultation

The following figure illustrates a successful call between Yealink SIP IP phones in which two parties are in a call and then one of the parties transfers the call to the third party with consultation. This is called attended transfer. In this call flow scenario, the end users are User A, User B, and User C. They are all using Yealink SIP IP phones, which are connected via an IP network.

The call flow scenario is as follows:

1. User A calls User B.
2. User B answers the call.
3. User A calls User C.
4. User C answers the call.

5. User A transfers the call to User C.
Call is established between User B and User C.

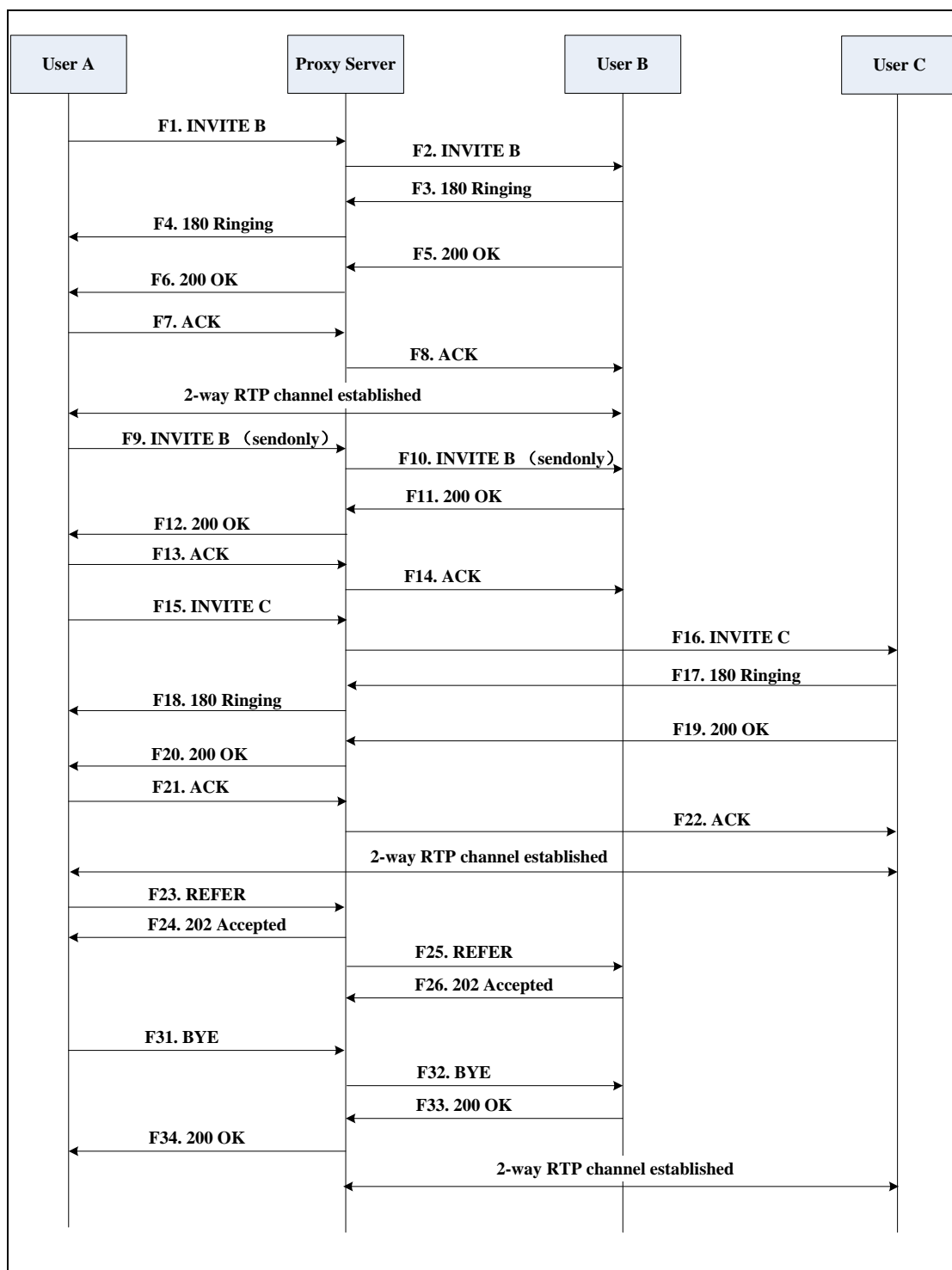

Step	Action	Description
F1	INVITE—User A to Proxy Server	<p>User A sends an INVITE message to a proxy server. The INVITE request is an invitation to User B to participate in a call session.</p> <p>In the INVITE request:</p> <ul style="list-style-type: none"> • The IP address of User B is inserted in the Request-URI field. • User A is identified as the call session initiator in the From field. • A unique numeric identifier is assigned to the call and is inserted in the Call-ID field. • The transaction number within a single call leg is identified in the CSeq field. • The media capability User A is ready to receive is specified. • The port on which User B is prepared to receive the RTP data is specified.
F2	INVITE—Proxy Server to User B	The proxy server maps the SIP URI in the To field to User B. The proxy server sends the INVITE message to User B.
F3	180 Ringing—User B to Proxy Server	User B sends a SIP 180 Ringing response to the proxy server. The 180 Ringing response indicates that the user is being alerted.
F4	180 Ringing—Proxy Server to User A	The proxy server forwards the 180 Ringing response to User A. User A hears the ring-back tone indicating that User B is being alerted.
F5	200 OK—User B to Proxy Server	User B sends a SIP 200 OK response to the proxy server. The 200 OK response notifies User A that the connection has been made.
F6	200 OK—Proxy Server to User A	The proxy server forwards the 200 OK message to User A. The 200 OK response notifies User A that the connection has been made.

Step	Action	Description
F7	ACK—User A to Proxy Server	User A sends a SIP ACK to the proxy server, The ACK confirms that User A has received the 200 OK response. The call session is now active.
F8	ACK—Proxy Server to User B	The proxy server sends the SIP ACK to User B. The ACK confirms that the proxy server has received the 200 OK response. The call session is now active.
F9	INVITE—User A to Proxy Server	User A sends a mid-call INVITE request to the proxy server with new SDP session parameters, which are used to place the call on hold.
F10	INVITE—Proxy Server to User B	The proxy server forwards the mid-call INVITE message to User B.
F11	200 OK—User B to Proxy Server	User B sends a SIP 200 OK response to the proxy server. The 200 OK response notifies User A that the INVITE was successfully processed.
F12	200 OK—Proxy Server to User A	The proxy server forwards the 200 OK response to User A. The 200 OK response notifies User B is successfully placed on hold.
F13	ACK—User A to Proxy Server	User A sends an ACK message to the proxy server. The ACK confirms that User A has received the 200 OK response. The call session is now temporarily inactive. No RTP packets are being sent.
F14	ACK—Proxy Server to User B	The proxy server sends the ACK message to User B. The ACK confirms that the proxy server has received the 200 OK response.
F15	INVITE—User A to Proxy Server	User A sends a SIP INVITE request to the proxy server. In the INVITE request, a unique Call-ID is generated and the Contact-URI field indicates that User A requests the call.
F16	INVITE—Proxy Server to User	The proxy server maps the SIP URI in the To field to User C. The proxy server

Step	Action	Description
	C	sends the INVITE request to User C.
F17	180 Ringing—User C to Proxy Server	User C sends a SIP 180 Ringing response to the proxy server. The 180 Ringing response indicates that the user is being alerted.
F18	180 Ringing—Proxy Server to User A	The proxy server forwards the 180 Ringing response to User A. User A hears the ring-back tone indicating that User C is being alerted.
F19	200OK—User C to Proxy Server	User C sends a SIP 200 OK response to the proxy server. The 200 OK response notifies User A that the connection has been made.
F20	200OK—Proxy Server to User A	The proxy server forwards the SIP 200 OK response to User A. The 200 OK response notifies User A that the connection has been made.
F21	ACK— User A to Proxy Server	User A sends a SIP ACK to the proxy server. The ACK confirms that User A has received the 200 OK response. The call session is now active.
F22	ACK—Proxy Server to User C	The proxy server forwards the ACK message to User C. The ACK confirms that the proxy server has received the 200 OK response. The call session is now active.
F23	REFER—User A to Proxy Server	User A sends a REFER message to the proxy server. User A performs a transfer of User B to User C.
F24	202 Accepted—Proxy Server to User A	The proxy server sends a SIP 202 Accepted response to User A. The 202 Accepted response notifies User A that the proxy server has received the REFER message.
F25	REFER—Proxy Server to User B	The proxy server forwards the REFER message to User B.
F26	202 Accepted—User B to Proxy Server	User B sends a SIP 202 Accept response to the proxy server. The 202 Accepted

Step	Action	Description
		response indicates that User B accepts the transfer.
F27	BYE—User A to Proxy Server	User A terminates the call session by sending a SIP BYE request to the proxy server. The BYE request indicates that User A wants to release the call.
F28	BYE—Proxy Server to User B	The proxy server forwards the BYE request to User B.
F29	200OK—User B to Proxy Server	User B sends a SIP 200 OK response to the proxy server. The 200 OK response notifies User A that User B has received the BYE request.
F30	200OK—Proxy Server to User A	The proxy server forwards the SIP 200 OK response to User A.

Always Call Forward

The following figure illustrates successful call forwarding between Yealink SIP IP phones in which User B has enabled always call forward. The incoming call is immediately forwarded to User C when User A calls User B. In this call flow scenario, the end users are User A, User B, and User C. They are all using Yealink SIP IP phones, which are connected via an IP network.

The call flow scenario is as follows:

1. User B enables always call forward, and the destination number is User C.
2. User A calls User B.
3. User B forwards the incoming call to User C.

4. User C answers the call.
Call is established between User A and User C.

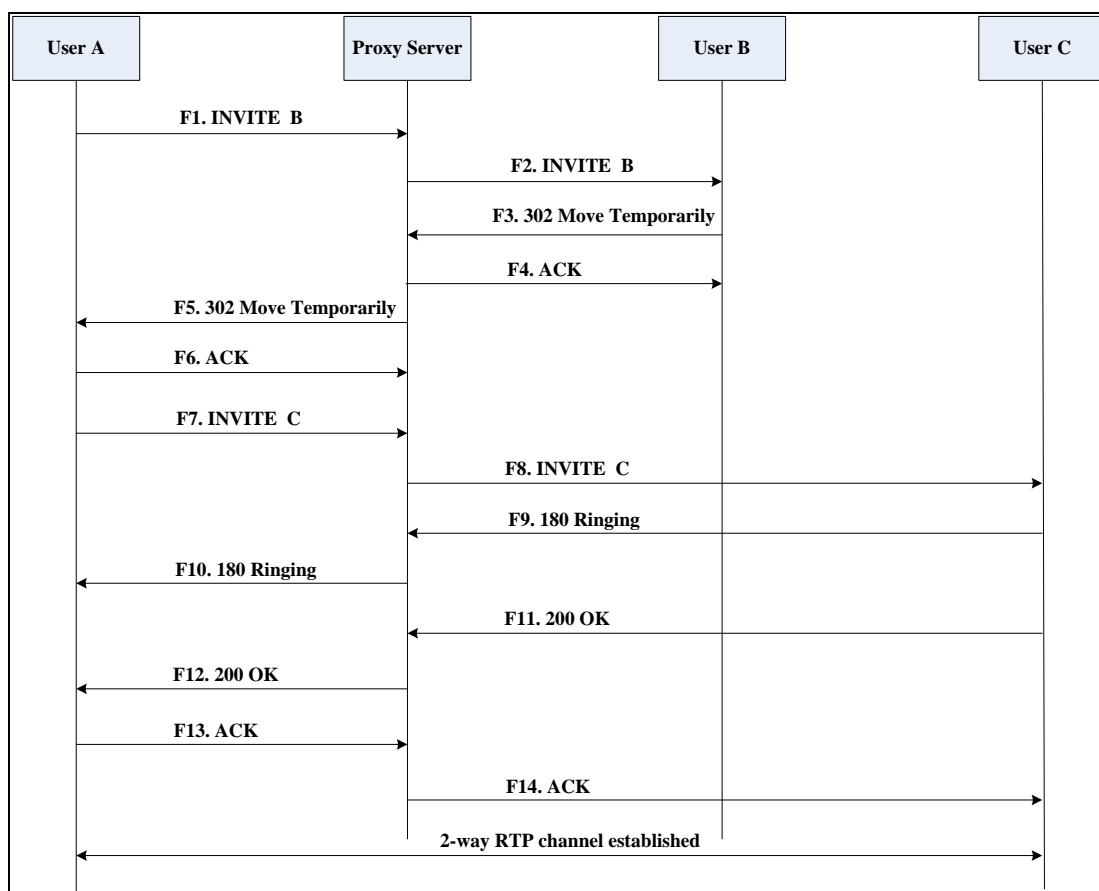

Step	Action	Description
F1	INVITE—User A to Proxy Server	<p>User A sends an INVITE message to a proxy server. The INVITE request is an invitation to User B to participate in a call session.</p> <p>In the INVITE request:</p> <ul style="list-style-type: none"> The IP address of the User B is inserted in the Request-URI field. User A is identified as the call session initiator in the From field. A unique numeric identifier is assigned to the call and is inserted in the Call-ID field. The transaction number within a single call leg is identified in the

Step	Action	Description
		<p>CSeq field.</p> <ul style="list-style-type: none"> The media capability User A is ready to receive is specified. The port on which User B is prepared to receive the RTP data is specified.
F2	INVITE—Proxy Server to User B	The proxy server maps the SIP URI in the To field to User B. The proxy server sends the INVITE message to User B.
F3	302 Move Temporarily—User B to Proxy Server	User B sends a SIP 302 Moved Temporarily message to the proxy server. The message indicates that User B is not available at SIP phone B. User B rewrites the contact-URI.
F4	ACK—Proxy Server to User B	The proxy server sends a SIP ACK to User B, the ACK message notifies User B that the proxy server has received the 302 Move Temporarily message.
F5	302 Move Temporarily—Proxy Server to User A	The proxy server forwards the 302 Moved Temporarily message to User A.
F6	ACK—User A to Proxy Server	User A sends a SIP ACK to the proxy server. The ACK message notifies the proxy server that User A has received the 302 Move Temporarily message.
F7	INVITE—User A to Proxy Server	User A sends a SIP INVITE request to the proxy server. In the INVITE request, a unique Call-ID is generated and the Contact-URI field indicates that User A requested the call.
F8	INVITE—Proxy Server to User C	The proxy server maps the SIP URI in the To field to User C. The proxy server sends the SIP INVITE request to User C.
F9	180 Ringing—User C to Proxy Server	User C sends a SIP 180 Ringing response to the proxy server. The 180 Ringing response indicates that the user is being alerted.
F10	180 Ringing—Proxy Server to User A	The proxy server forwards the 180 Ringing response to User A. User A

Step	Action	Description
		hears the ring-back tone indicating that User C is being alerted.
F11	200OK—User C to Proxy Server	User C sends a SIP 200 OK response to the proxy server. The 200 OK response notifies User A that the connection has been made.
F12	200OK—Proxy Server to User A	The proxy server forwards the SIP 200 OK response to User A. The 200 OK response notifies User A that the connection has been made.
F13	ACK—User A to Proxy Server	User A sends a SIP ACK to the proxy server. The ACK confirms that User A has received the 200 OK response. The call session is now active.
F14	ACK—Proxy Server to User C	The proxy server forwards the ACK message to User C. The ACK confirms that the proxy server has received the 200 OK response. The call session is now active.

Busy Call Forward

The following figure illustrates successful call forwarding between Yealink SIP IP phones in which User B has enabled busy call forward. The incoming call is forwarded to User C when User B is busy. In this call flow scenario, the end users are User A, User B, and User C. They are all using Yealink SIP IP phones, which are connected via an IP network.

The call flow scenario is as follows:

1. User B enables busy call forward, and the destination number is User C.
2. User A calls User B.
3. User B is busy.
4. User B forwards the incoming call to User C.
5. User C answers the call.

Call is established between User A and User C.

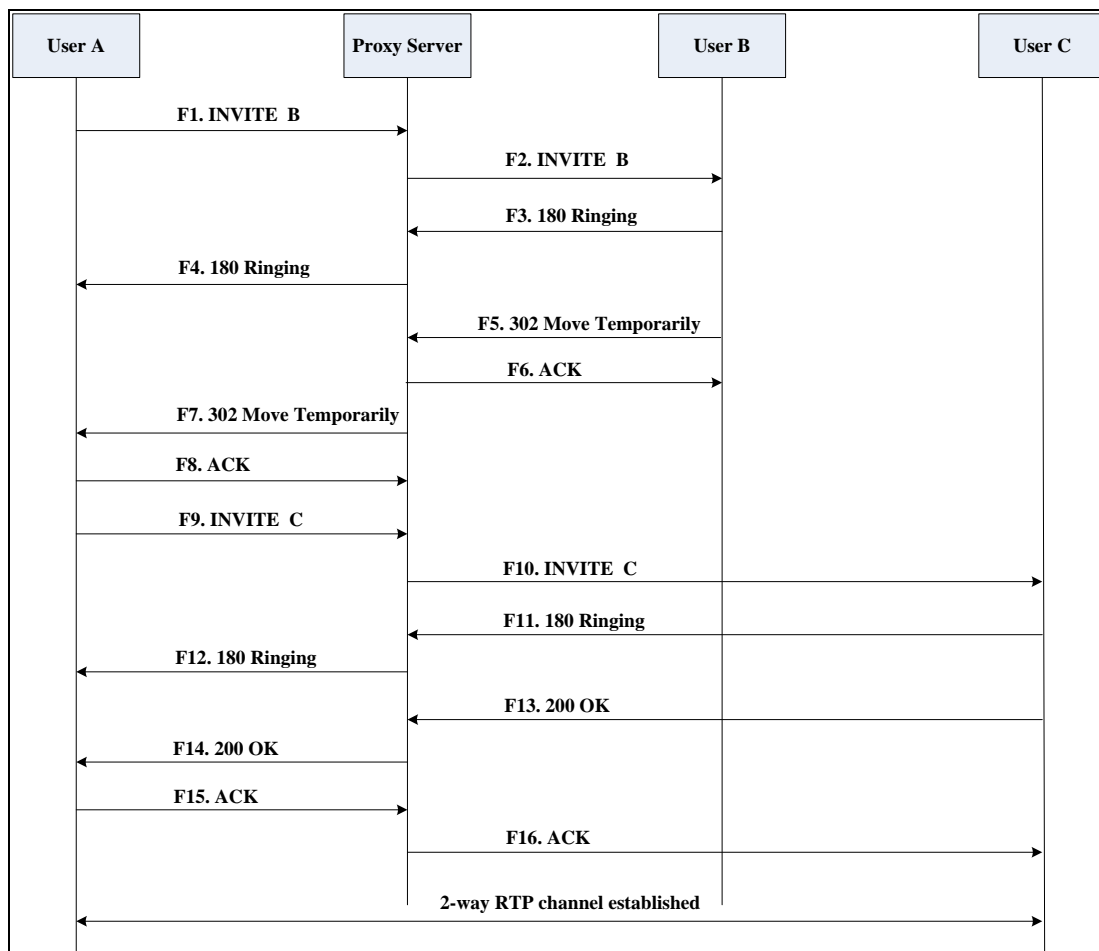

Step	Action	Description
F1	INVITE—User A to Proxy Server	<p>User A sends the INVITE message to a proxy server. The INVITE request is an invitation to User B to participate in a call session.</p> <p>In the INVITE request:</p> <ul style="list-style-type: none"> The IP address of User B is inserted in the Request-URI field. User A is identified as the call session initiator in the From field. A unique numeric identifier is assigned to the call and is inserted in the Call-ID field. The transaction number within a single call leg is identified in the

Step	Action	Description
		CSeq field. <ul style="list-style-type: none"> • The media capability User A is ready to receive is specified. • The port on which User B is prepared to receive the RTP data is specified.
F2	INVITE—Proxy Server to User B	The proxy server maps the SIP URI in the To field to User B. The proxy server sends the INVITE message to User B.
F3	180 Ringing—User B to Proxy Server	User B sends a SIP 180 Ringing response to the proxy server. The 180 Ringing response indicates that the user is being alerted.
F4	180 Ringing—Proxy Server to User A	The proxy server forwards the 180 Ringing response to User A. User A hears the ring-back tone indicating that User B is being alerted.
F5	302 Move Temporarily—User B to Proxy Server	User B sends a SIP 302 Moved Temporarily message to the proxy server. The message indicates that User B is not available at SIP phone B. User B rewrites the contact-URI.
F6	ACK—Proxy Server to User B	The proxy server sends a SIP ACK to User B, the ACK message notifies User B that the proxy server has received the ACK message.
F7	302 Move Temporarily—Proxy Server to User A	The proxy server forwards the 302 Moved Temporarily message to User A.
F8	ACK—User A to Proxy Server	User A sends a SIP ACK to the proxy server. The ACK message notifies the proxy server that User A has received the ACK message.
F9	INVITE—User A to Proxy Server	User A sends a SIP INVITE request to the proxy server. In the INVITE request, a unique Call-ID is generated and the Contact-URI field indicates that User A requests the call.
F10	INVITE—Proxy Server to User	The proxy server forwards the SIP

Step	Action	Description
	C	INVITE request to User C.
F11	180 Ringing—User C to Proxy Server	User C sends a SIP 180 Ringing response to the proxy server. The 180 Ringing response indicates that the user is being alerted.
F12	180 Ringing—Proxy Server to User A	The proxy server forwards the 180 Ringing response to User A. User A hears the ring-back tone indicating that User C is being alerted.
F13	200OK—User C to Proxy Server	User C sends a SIP 200 OK response to the proxy server. The 200 OK response notifies User A that the connection has been made.
F14	200OK—Proxy Server to User A	The proxy server forwards the SIP 200 OK response to User A.
F15	ACK— User A to Proxy Server	User A sends a SIP ACK to the proxy server. The ACK confirms that User A has received the 200 OK response. The call session is now active.
F16	ACK—Proxy Server to User C	The proxy server sends the ACK message to User C.

No Answer Call Forward

The following figure illustrates successful call forwarding between Yealink SIP IP phones in which User B has enabled no answer call forward. The incoming call is forwarded to User C when User B does not answer the incoming call after a period of time. In this call flow scenario, the end users are User A, User B, and User C. They are all using Yealink SIP IP phones, which are connected via an IP network.

The call flow scenario is as follows:

1. User B enables no answer call forward, and the destination number is User C.
2. User A calls User B.
3. User B does not answer the incoming call.
4. User B forwards the incoming call to User C.
5. User C answers the call.

Call is established between User A and User C.

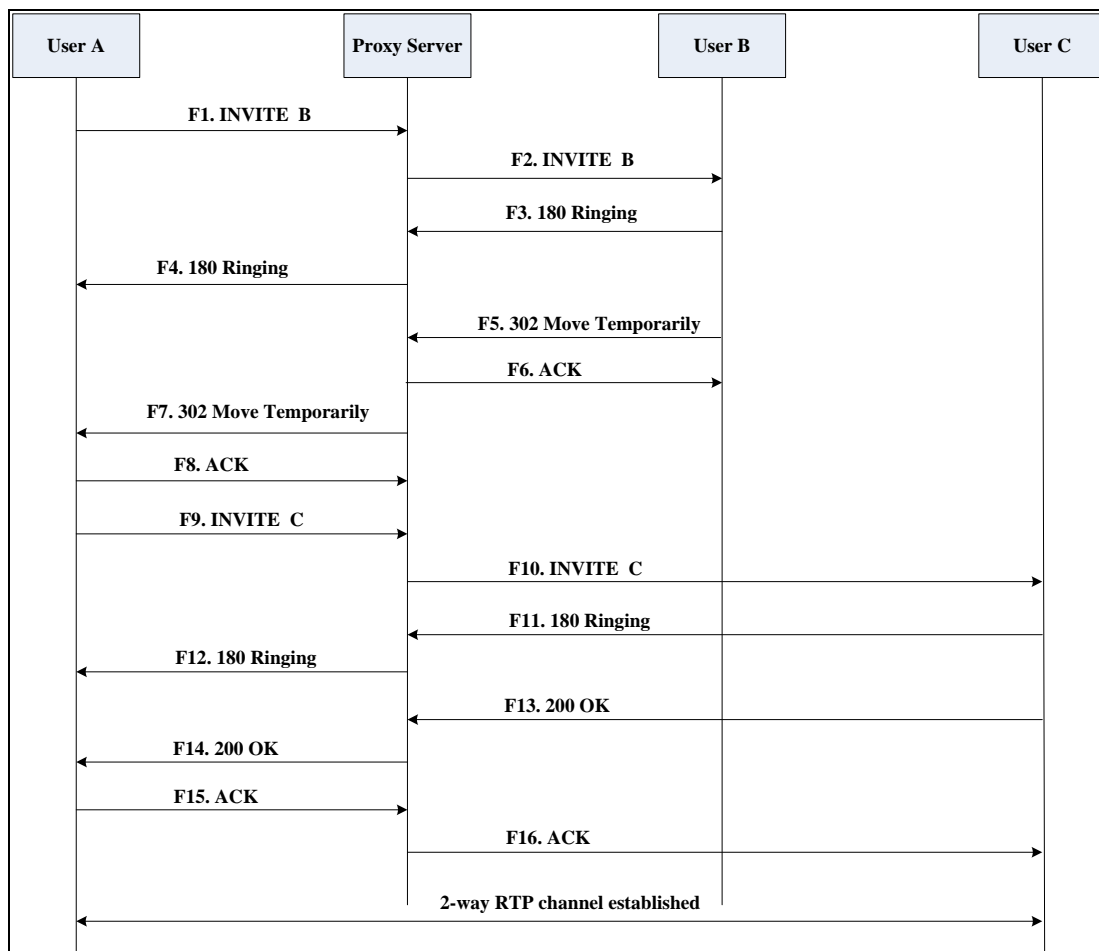

Step	Action	Description
F1	INVITE—User A to Proxy Server	<p>User A sends the INVITE message to a proxy server. The INVITE request is an invitation to User B to participate in a call session.</p> <p>In the INVITE request:</p> <ul style="list-style-type: none"> The IP address of User B is inserted in the Request-URI field. User A is identified as the call session initiator in the From field. A unique numeric identifier is assigned to the call and is inserted in the Call-ID field. The transaction number within a single call leg is identified in the

Step	Action	Description
		<p>CSeq field.</p> <ul style="list-style-type: none"> The media capability User A is ready to receive is specified. The port on which User B is prepared to receive the RTP data is specified.
F2	INVITE—Proxy Server to User B	The proxy server maps the SIP URI in the To field to User B. The proxy server sends the INVITE message to User B.
F3	180 Ringing—User B to Proxy Server	User B sends a SIP 180 Ringing response to the proxy server. The 180 Ringing response indicates that the user is being alerted.
F4	180 Ringing—Proxy Server to User A	The proxy server forwards the 180 Ringing response to User A. User A hears the ring-back tone indicating that User B is being alerted.
F5	302 Move Temporarily—User B to Proxy Server	User B sends a SIP 302 Moved Temporarily message to the proxy server. The message indicates that User B is not available at SIP phone B. User B rewrites the contact-URI.
F6	ACK—Proxy Server to User B	The proxy server sends a SIP ACK to User B, the ACK message notifies User B that the proxy server has received the ACK message.
F7	302 Move Temporarily—Proxy Server to User A	The proxy server forwards the 302 Moved Temporarily message to User A.
F8	ACK—User A to Proxy Server	User A sends a SIP ACK to the proxy server. The ACK message notifies the proxy server that User A has received the ACK message.
F9	INVITE—User A to Proxy Server	User A sends a SIP INVITE request to the proxy server. In the INVITE request, a unique Call-ID is generated and the Contact-URI field indicates that User A requests the call.
F10	INVITE—Proxy Server to User	The proxy server forwards the SIP

Step	Action	Description
	C	INVITE request to User C.
F11	180 Ringing—User C to Proxy Server	User C sends a SIP 180 Ringing response to the proxy server. The 180 Ringing response indicates that the user is being alerted.
F12	180 Ringing—Proxy Server to User A	The proxy server forwards the 180 Ringing response to User A. User A hears the ring-back tone indicating that User C is being alerted.
F13	200OK—User C to Proxy Server	User C sends a SIP 200 OK response to the proxy server. The 200 OK response notifies User A that the connection has been made.
F14	200OK—Proxy Server to User A	The proxy server forwards the SIP 200 OK response to User A. The 200 OK response notifies User A that the connection has been made.
F15	ACK— User A to Proxy Server	User A sends a SIP ACK to the proxy server. The ACK confirms that User A has received the 200 OK response. The call session is now active.
F16	ACK—Proxy Server to User C	The proxy server sends the ACK message to User C. The ACK confirms that the proxy server has received the 200 OK response.

Call Conference

The following figure illustrates successful 3-way calling between Yealink IP phones in which User A mixes two RTP channels and therefore establishes a conference between User B and User C. In this call flow scenario, the end users are User A, User B, and User C. They are all using Yealink SIP IP phones, which are connected via an IP network.

The call flow scenario is as follows:

1. User A calls User B.
2. User B answers the call.
3. User A places User B on hold.
4. User A calls User C.
5. User C answers the call.

- User A mixes the RTP channels and establishes a conference between User B and User C.

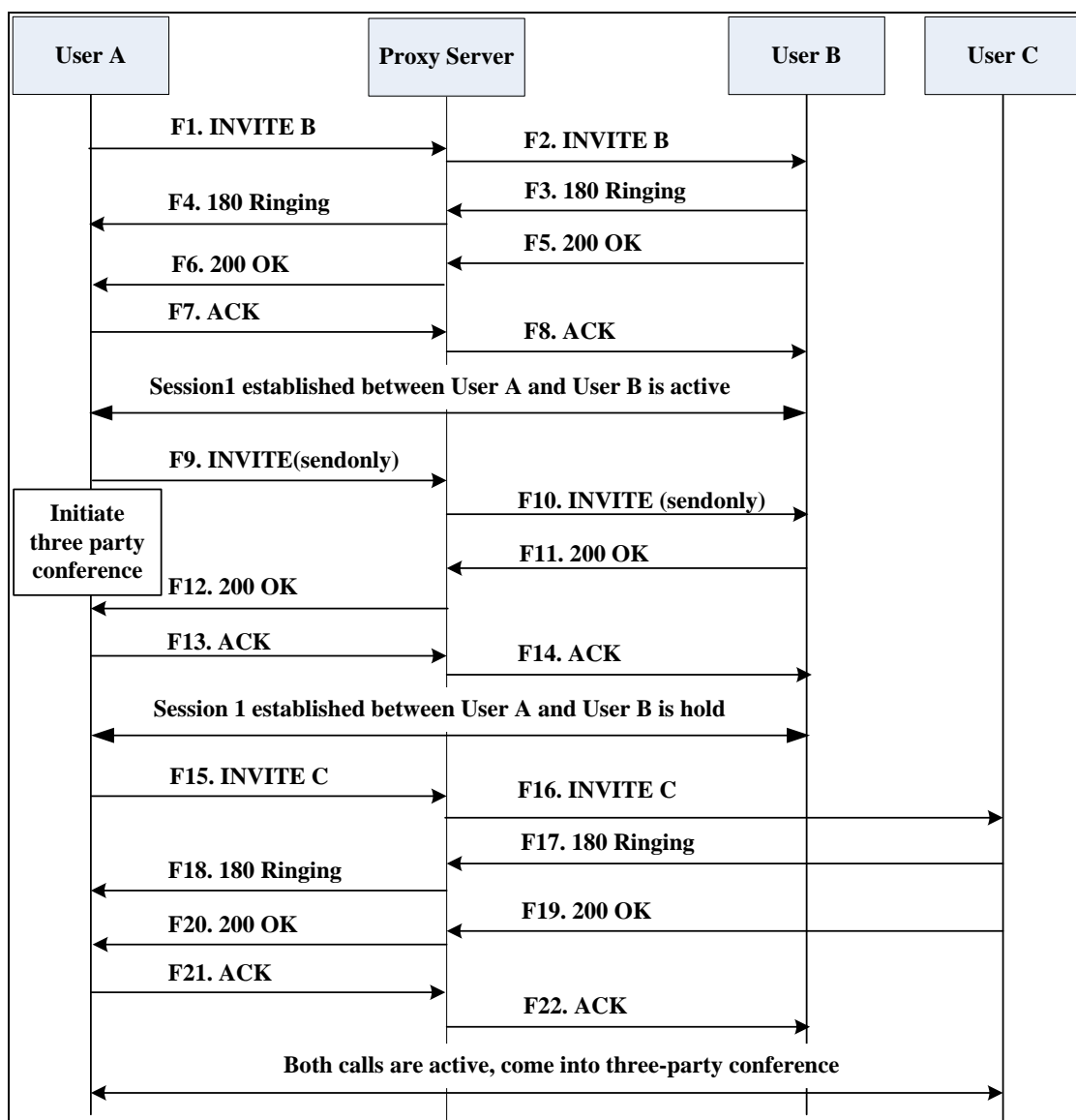

Step	Action	Description
F1	INVITE—User A to Proxy Server	<p>User A sends the INVITE message to a proxy server. The INVITE request is an invitation to User B to participate in a call session.</p> <p>In the INVITE request:</p> <ul style="list-style-type: none"> The IP address of User B is inserted in the Request-URI field.

Step	Action	Description
		<ul style="list-style-type: none"> • User A is identified as the call session initiator in the From field. • A unique numeric identifier is assigned to the call and is inserted in the Call-ID field. • The transaction number within a single call leg is identified in the CSeq field. • The media capability User A is ready to receive is specified. • The port on which User B is prepared to receive the RTP data is specified.
F2	INVITE—Proxy Server to User B	The proxy server maps the SIP URI in the To field to User B. Proxy server forwards the INVITE message to User B.
F3	180 Ringing—User B to Proxy Server	User B sends a SIP 180 Ringing response to the proxy server. The 180 Ringing response indicates that the user is being alerted.
F4	180 Ringing—Proxy Server to User A	The proxy server forwards the 180 Ringing response to User A. User A hears the ring-back tone indicating that User B is being alerted.
F5	200 OK—User B to Proxy Server	User B sends a SIP 200 OK response to the proxy server. The 200 OK response notifies User A that the connection has been made.
F6	200 OK—Proxy Server to User A	The proxy server forwards the 200 OK message to User A. The 200 OK response notifies User A that the connection has been made.
F7	ACK—User A to Proxy Server	User A sends a SIP ACK to the proxy server. The ACK confirms that User A has received the 200 OK response. The call session is now active.
F8	ACK—Proxy Server to User B	The proxy server sends the SIP ACK to User B. The ACK confirms that the proxy server has received the 200 OK

Step	Action	Description
		response. The call session is now active.
F9	INVITE—User A to Proxy Server	User A sends a mid-call INVITE request to the proxy server with new SDP session parameters, which are used to place the call on hold.
F10	INVITE—Proxy Server to User B	The proxy server forwards the mid-call INVITE message to User B.
F11	200 OK—User B to Proxy Server	User B sends a SIP 200 OK response to the proxy server. The 200 OK response notifies User A that the INVITE is successfully processed.
F12	200 OK—Proxy Server to User A	The proxy server forwards the 200 OK response to User A. The 200 OK response notifies User A that User B is successfully placed on hold.
F13	ACK—User A to Proxy Server	User A sends the ACK message to the proxy server. The ACK confirms that User A has received the 200 OK response. The call session is now temporarily inactive. No RTP packets are being sent.
F14	ACK—Proxy Server to User B	The proxy server sends the ACK message to User B. The ACK confirms that the proxy server has received the 200 OK response.
F15	INVITE—User A to Proxy Server	User A sends a SIP INVITE request to the proxy server. In the INVITE request, a unique Call-ID is generated and the Contact-URI field indicates that User A requests the call.
F16	INVITE—Proxy Server to User C	The proxy server maps the SIP URI in the To field to User C. The proxy server sends the SIP INVITE request to User C.
F17	180 Ringing—User C to Proxy Server	User C sends a SIP 180 Ringing response to the proxy server. The 180 Ringing response indicates that the user is being alerted.
F18	180 Ringing—Proxy Server to	The proxy server forwards the 180

Step	Action	Description
	User A	Ringing response to User A. User A hears the ring-back tone indicating that User C is being alerted.
F19	200OK—User C to Proxy Server	User C sends a SIP 200 OK response to the proxy server. The 200 OK response notifies User A that the connection has been made.
F20	200OK—Proxy Server to User A	The proxy server forwards the SIP 200 OK response to User A. The 200 OK response notifies User A that the connection has been made.
F21	ACK— User A to Proxy Server	User A sends a SIP ACK to the proxy server. The ACK confirms that User A has received the 200 OK response. The call session is now active.
F22	ACK—Proxy Server to User C	The proxy server sends the ACK message to User C. The ACK confirms that the proxy server has received the 200 OK response.

Index

Numeric

- 180 Ring Workaround [269](#)
- 802.1X Authentication [702](#)

A

- About This Guide [v](#)
- Accept SIP Trust Server Only [240](#)
- Account Registration [112](#)
- Acoustic Echo Cancellation [661](#)
- Action URL [505](#)
- Action URI [526](#)
- Administrator Password [671](#)
- Allow IP Call [239](#)
- Allow Trans Exist Call [315](#)
- Always Forward [284](#)
- Analyzing the Configuration Files [730](#)
- Anonymous Call [242](#)
- Anonymous Call Rejection [247](#)
- Appendix [747](#)
- Appendix A: Glossary [747](#)
- Appendix B: Time Zones [749](#)
- Appendix C: Trusted Certificates [749](#)
- Appendix D: SIP [767](#)
- Appendix E: SIP Call Flows [784](#)
- Area Code [190](#)
- Attach the Stand [18](#)
- Attended Transfer [305](#)
- Audio Codecs [651](#)
- Auto Answer [232](#)
- Auto-Logout Time [672](#)
- Automatic Call Distribution [442](#)
- Auto Redial [230](#)
- Auto Provisioning Flowchart [767](#)

B

- Backlight [99](#)
- Blind Transfer [305](#)
- BLF List [433](#)

- Block Out [192](#)
- Bluetooth [107](#)
- Bridge Lines Appearance (BLA) [462](#)
- Busy Forward [284](#)
- Busy Lamp Field [420](#)
- Busy Tone Delay [262](#)

C

- Call Completion [239](#)
- Call Forward [284](#)
- Call Hold [278](#)
- Call Number Filter [346](#)
- Call Park [346](#)
- Call Recording [488](#)
- Call Timeout [380](#)
- Call Transfer [305](#)
- Call Waiting [224](#)
- Calling Line Identification Presentation [351](#)
- Connected Line Identification Presentation [357](#)
- Capturing Packets [725](#)
- Capturing the Current Screen of the Phone [532](#)
- CDP [564](#)
- Comfort Noise Generation [664](#)
- Configuration Files [38](#)
- Configuration Methods [38](#)
- Configuring Advanced features [380](#)
- Configuring Basic Features [89](#)
- Configuring Basic Network Parameters [58](#)
- Configuring Security Features [669](#)
- Connecting the IP phone [17](#)
- Contrast [97](#)

D

- DHCP [58](#)
- DHCP Option [62](#)
- Dial Plan [179](#)
- Dial-now [184](#)
- Dial-now Template [187](#)

Directed Call Pickup [315](#)

Directory [199](#)

Display Method on Dialing [126](#)

Distinctive Ring Tones [632](#)

Do Not Disturb (DND) [251](#)

Documentations [v](#)

DTMF [359](#)

Dual Headset [647](#)

E

Early Media [269](#)

Enable Page Tips [109](#)

Encrypting Configuration Files [696](#)

Enabling the Watch Dog Feature [728](#)

F

Feature Key Synchronization [310](#)

G

Getting Information from Status Indicators [730](#)

Getting Started [17](#)

Group Call Pickup [325](#)

H

H.323 [1](#)

Headset Prior [646](#)

Hide Features Access Code [442](#)

Hot Desking [496](#)

Hotline [194](#)

I

In This Guide [v](#)

Index [823](#)

Initialization Process Overview [27](#)

Input Method Customization [158](#)

Intercom [372](#)

IPv6 Support [617](#)

IP Direct Auto Answer [237](#)

J

Jitter Buffer [665](#)

K

Keep User Personalized Settings [45](#)

Key As Send [175](#)

Key Features of IP Phones [13](#)

L

Label Length [110](#)

Language [145](#)

Expansion Module [14](#)

LDAP [407](#)

Live Dialpad [222](#)

LLDP [561](#)

Loading Language Packs [149](#)

Local Contact File [209](#)

Local Directory [209](#)

Logo Customization [163](#)

Logon Wizard [504](#)

M

Message Waiting Indicator [450](#)

Missed Call Log [207](#)

Multicast Paging [469](#)

N

NAT Traversal [600](#)

Network Address Translation (NAT) [598](#)

Network Conference [308](#)

No Answer Forward [284](#)

Notification Popups [94](#)

O

Off Hook Hot Line Dialing [196](#)

P

Password Dial [388](#)

Phone Lock [674](#)

Phone User Interface [38](#)

Physical Features of IP Phones [4](#)

Power Indicator LED [91](#)

Product Overview [1](#)

Q

Quality of Service 577

R

Reading Icons 28

Reboot in Talking 396

ReCall 340

Redial Tone 227

Reliable Retransmission 394

Remote Phone Book 400

Remote XML Phone Book 400

Replace Rule 180

Replace Rule Template 182

Reserve # in User Name 388

Return Message When DND 252

Return Code When Refuse 267

RFC and Internet Draft Support 775

Ringer Device for Headset 229

Ringing Timeout 381

Ring Tones 627

RTCP-XR 576

S

Save Call Log 204

Search Source List in Dialing 201

Semi-attended Transfer 305

Send user=phone 381

Send Volume 650

Server Redundancy 534

Session Timer 275

Shared Call Appearance (SCA) 450

Short Message Service (SMS) 471

SIP 767

SIP Components 1

SIP Header 779

SIP IP Phone Models 3

SIP Request 775

SIP Responses 781

SIP Send Line 386

SIP Send MAC 384

SIP Session Description Protocol Usage 783

SIP Session Timer 273

Softkey Layout 167

Specifying the Language to Use 156

SRTP 694

Static DNS 60

STUN Server 600

Suppress DTMF Display 365

T

Table of Contents x

Time and Date 130

Transfer on Conference Hang Up 312

Transfer Mode via Dsskey 313

Transfer via DTMF 367

Transport Layer Security (TLS) 684

Troubleshooting 715

Troubleshooting Methods 715

Troubleshooting Solutions 730

TR-069 Device Management 611

U

Unregister When Reboot 392

Upgrading Firmware 81

Use Outbound Proxy in Dialog 271

User Agent Client (UAC) 1

User Agent Server (UAS) 1

User Password 669

V

Verifying Startup 28

Viewing Log Files 715

VLAN 560

Voice Activity Detection 662

Voice Mail Tone 645

Voice Quality Monitoring 576

VoIP Principle 1

VPN 573

VQ-RTCPXR 577

W

Web Server Type 126

Web User Interface 38